

# GENERAL CATALOG

---

---

**BROADCAST, COMMUNICATIONS  
AND ELECTRONIC EQUIPMENT**



If You Didn't Get This From My Site,  
Then It Was Stolen From...

[www.SteamPoweredRadio.Com](http://www.SteamPoweredRadio.Com)

# Introduction

.....

*The equipment listed in this catalog is among the most comprehensive ever offered to the broadcast, communications and associated industries. Gates has prepared this catalog both as an informative book and a buying guide. Though provided to list all major items of manufacture by Gates, this catalog also lists parts and complete equipments manufactured by other reputable companies that have entered into distributing arrangements with Gates. Almost without exception, every item listed is carried in stock at either the main Gates factory and warehouses at Quincy, Illinois, or the factory warehouse branch.*

*Our field sales, service and engineering are international in scope. Field sales engineers travel all areas of the United States. In addition to our main sales and engineering offices in Quincy, Illinois, branch offices are in Washington, D. C. and Houston. The Houston branch carries a generous inventory of capital equipment as well as service parts. Sales in Canada are handled exclusively by the Canadian Marconi Company with its branches in every major city in Canada. International sales are handled by the international department of the Gates Radio Company, located at 13 E. 40th Street in New York City.*

*Established in 1922 and nearing forty years of service, Gates is the senior member in the broadcasting fraternity of many fine manufacturing concerns. Gates has consistently led in new and progressive designs. Recognizing quality as of first importance, progressive engineering is backed by a strict manufacturing quality control in one of the world's most modern electronics factories.*

*Gates is a member of the Harris-Intertype Corporation family, world leader in the Graphic Arts field. In addition to the two large Gates factories in Quincy, Illinois, this family includes manufacturing plants in Brooklyn; Cleveland; Dayton; Los Angeles; Westerly, R. I.; Slough, England and West Berlin, Germany.*

*If your need is in radio broadcasting, television broadcasting, communications or industrial electronics, we wholeheartedly invite your patronage. Everyone in the Gates organization will do his very best to justify the confidence placed in us.*

**GATES RADIO COMPANY**

SUBSIDIARY OF HARRIS-INTERTYPE CORPORATION

# GATES OFFICES and FACTORIES



Above is the Gates Broadway factory, built in 1953 and considered one of the electronic industry's most modern manufacturing plants. The heavy transmitters and other large electronic systems are manufactured here.



Gates Second and Hampshire street facility. Here are the administration offices, development laboratories, engineering, special equipment, cabling and audio construction departments.



Gates warehouse and regular shipping point. It is one of the most strategically located buildings in Quincy in relation to air, rail and truck shipping.



Houston, Texas, stock carrying branch located at 2700 Polk Avenue, telephone Capitol 8-8536.

## WASHINGTON OFFICE

Complete sales engineering, across from FCC offices, Warner Building, 13th & E Streets, N.W., telephone Metropolitan 8-0522.

## THROUGHOUT CANADA

The Canadian Marconi Company, with main office in Montreal and branches in all principal Canadian cities. Telephone Atlantic 9441 in Montreal.

## INTERNATIONAL

World-wide sales are conducted by the Gates International Division, 13 East 40th Street, New York City. Cable address ARLAB.

## GATES RADIO COMPANY

*Subsidiary of Harris-Intertype Corporation*

QUINCY, ILLINOIS

Telephone BALdwin 2-8202

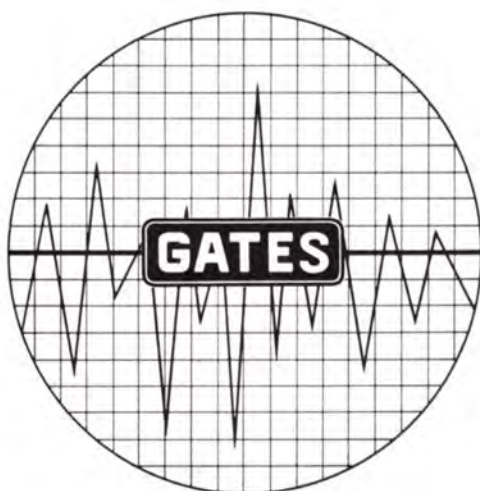

# CONTENTS

PAGE

SECTION

**5 . . . . BROADCAST TRANS-  
MITTERS (AM-FM-TV)  
AND ACCESSORIES**

**109 . . AUDIO EQUIPMENT  
AND ACCESSORIES**

**189 . . HIGH FREQUENCY  
AND COMMUNICATIONS  
TRANSMITTERS,  
ACCESSORIES**

**233 . . COMPLETE INDEX**

# NEW PRODUCTS

As the reader leafs through the pages of this new catalog, he will find improved versions of existing products and completely new types of equipment, which are continually being developed for the broadcast, communications, and industrial electronic industries. A complete index showing the extensive range of Gates products is found on Page 233. However, for quick reference on new broadcast equipment, a *partial* listing is shown below.

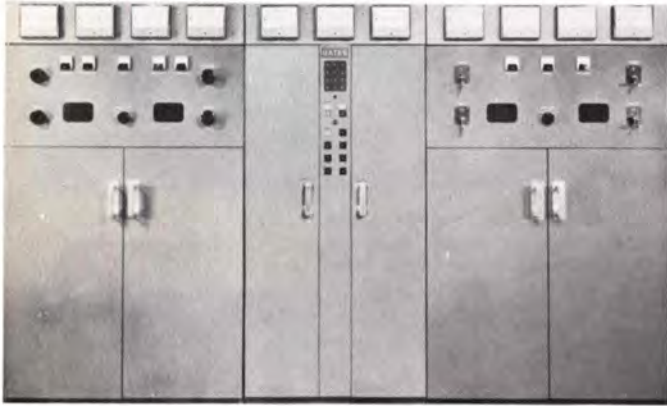

NEW. Gates BC-50C 50,000 watt AM Broadcast Transmitter. Small and compact with many outstanding features. Fully described, page 6 thru 11.



NEW. Gates FM-10A, 10,000 watt FM Broadcast Transmitter, featuring *Varia-Line* Tuning. Fully described, page 44 thru 47.



NEW. Gates BT-5C, 5,000 watt TV Transmitter for both color and monochrome transmission. Fully described, page 61 thru 65.



NEW. Gates *Carritape*, the tape transport and playback unit of an entirely new system. Fully described, page 144 thru 148.



NEW. Gates Spot Tape Recorder, accommodating 101 announcements on one tape, 13" wide. Fully described, page 140 thru 143.

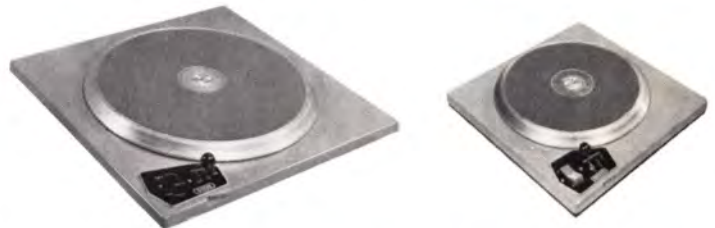

NEW. Gates CB-500 Turntable (16 inch) and CB-77 Turntable (12 inch), both designed with emphasis on true low rumble. Fully described on page 130 thru 133, 136, 137.



NEW. Gates M-5693 Modulation Monitor, operating on an entirely new principle. Fully described, pages 90 and 91.

Terms and condition of sale for Gates products are stated on Gates published price list, or will be supplied on request. All products listed in this catalog subject to stand-ard improvement.

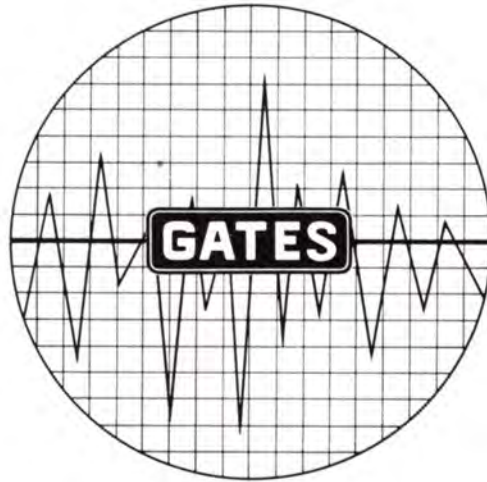

# **BROADCAST TRANSMITTERS AND ACCESSORIES**

## **PAGES**

<b>6- 43</b>	<b>AM BROADCAST TRANSMITTERS</b>
<b>44- 60</b>	<b>FM BROADCAST TRANSMITTERS</b>
<b>61- 77</b>	<b>TV BROADCAST TRANSMITTERS AND TV SYSTEMS</b>
<b>78-108</b>	<b>ACCESSORY EQUIPMENT</b>

# 50,000 WATT AM BROADCAST TRANSMITTER

Model BC-50C

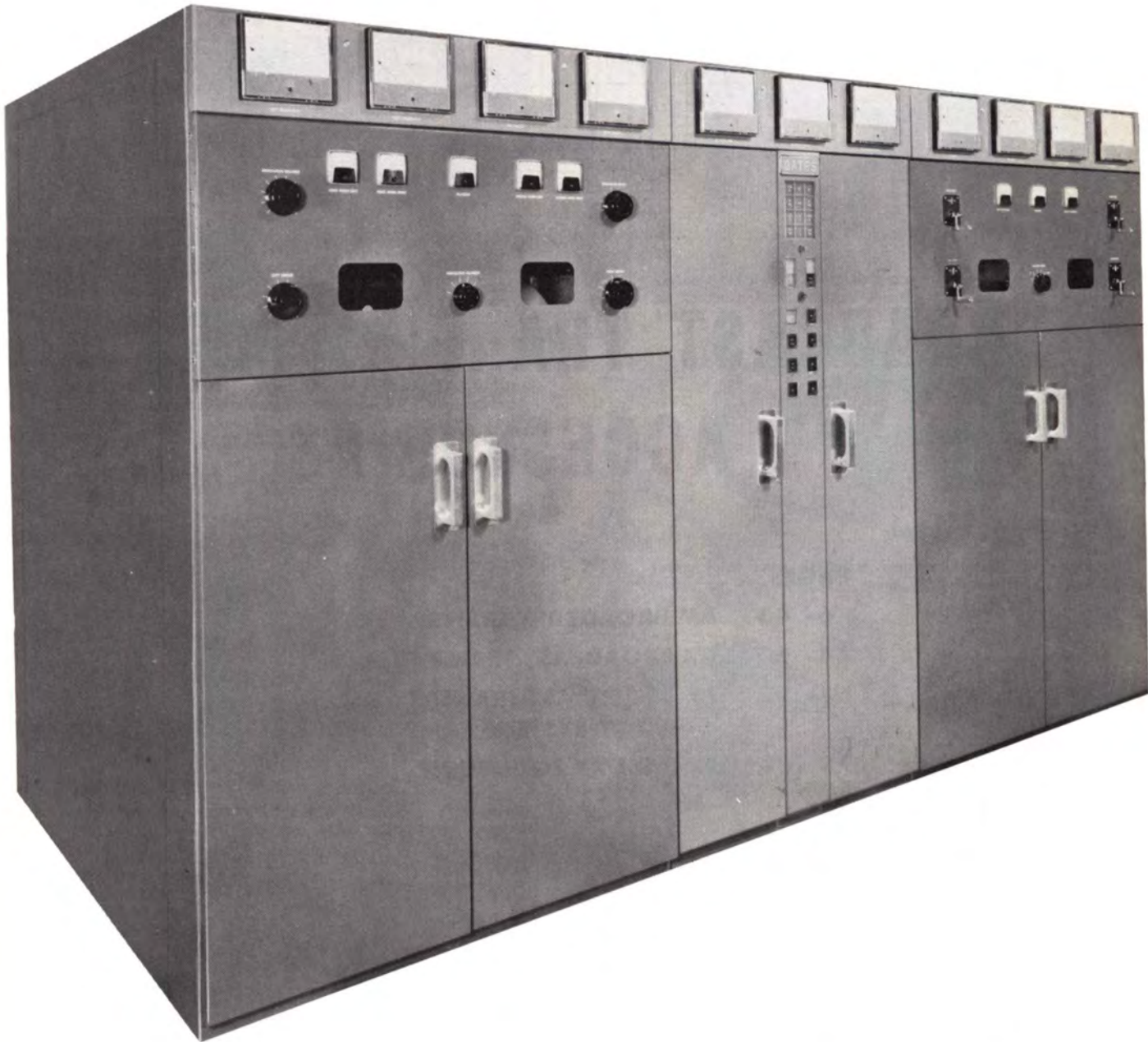

The New Gates BC-50C is an accumulation of nearly 40 years of engineering and manufacturing experience. Following the design considerations of several 50KW transmitters produced for the United States Information Agency, the new BC-50C offers many important new features, including the use of dry rectifiers throughout, compact size, external or internal air cooling, and the use of only 15 tubes of 6 types.

## BC-50C 50,000 WATT AM BROADCAST TRANSMITTER

**POWER AMPLIFIER CUBICLE:** PA cubicle houses two Westinghouse 5891 final amplifier tubes as well as all of the associated circuitry for the power amplifier itself. Access to the PA tubes is gained through the front doors of the transmitter and a convenient floor dolly is provided for changing tubes without any lifting. These tubes operate in parallel and are output coupled by a method to assure minimum harmonic and spurious radiation. A single 5891 is capable of producing 50 KW output. Tubes are operated at about 50% of manufacturer's rating.

**EXCITER DRIVER CUBICLE:** This is the center cubicle and measures 32" wide by 60" deep. The driver for the final amplifier consists of a single Amperex type 6076 tube, which provides more than sufficient power for driving the final amplifier to the transmitter's rated output power. This unit is cooled through the main circulating system by picking up air from the intake duct and through a separate blower, the driver-amplifier stage itself is cooled. Cooling more than sufficient to accommodate maximum plate dissipation in the 6076 tube is provided. This tube operates at approximately 60% of its capability.

**MODULATOR CUBICLE:** This cubicle houses two type 5891 modulator tubes. As in the case of the final amplifier, these tubes are accessible through the front doors of the transmitter. Modulator and final amplifier tubes are of the same type for standardization and spare tube stock.

The front section of the modulator cubicle is devoted to the Class B modulator stage itself. Cubicle is divided approximately 1/3 of distance from front to back and in back of this divider are all of the lower level audio stages. Audio input stage consisting of two type 6146 tubes is mounted near the base of the cubicle. The second audio stage consisting of two type 813 tubes is mounted immediately above and the audio driver stage consisting of two 833A tubes in a cathode follower driver circuit is mounted toward the top of the modulator cubicle.

**CONTROL CIRCUIT** — The design of the control system of the BC-50C transmitter is in keeping with the highest present day standards. The protection of valuable equipment, reliability and safety of personnel and simplicity of design were constantly kept in mind during the design stages of the BC-50C transmitter. All cubicle doors are interlocked, of course, and in addition are provided with automatic mechanical grounding switches for safety. The service lights inside the cubicles are also controlled by separate switches on the cubicle doors.

Desirable features such as reliable air pressure switches, an adequate number of status lights and the positive mechanical grounding switches mentioned above all contribute to protecting the transmitter and its operating personnel. The arrangement of the control circuit has been designed so that modifications and special applications often desired with a particular installation may readily be applied.

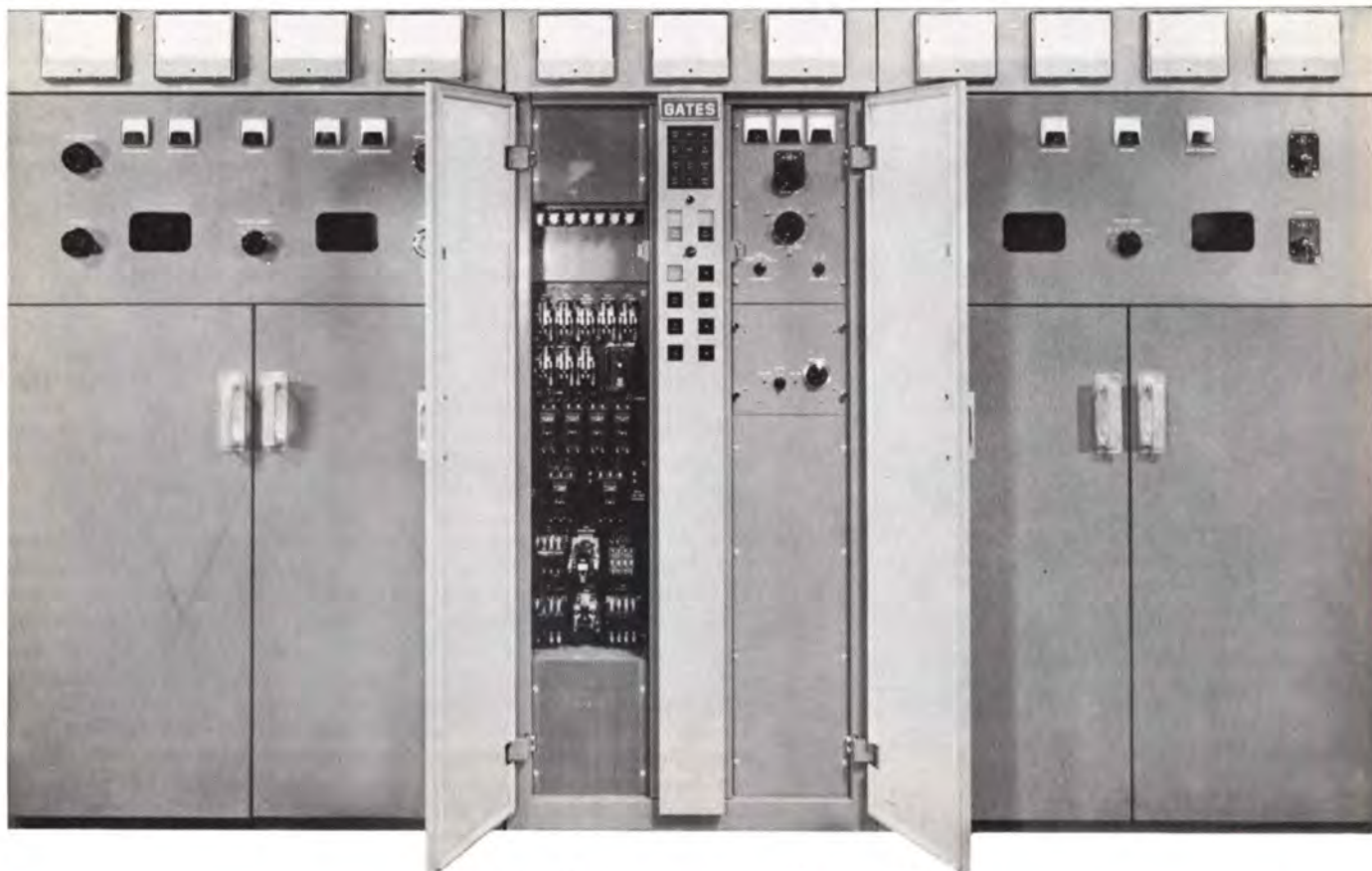

Front view showing supervisory and exciter cubicle.



**BC-50C 50,000 WATT AM BROADCAST TRANSMITTER**



Front view showing tubes — compact design.

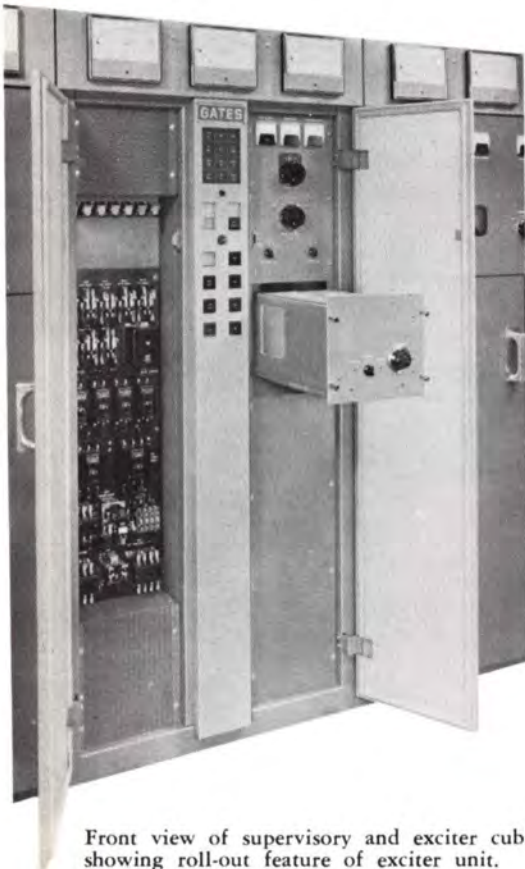

Front view of supervisory and exciter cubicle showing roll-out feature of exciter unit.

**COOLING SYSTEM** — The Gates BC-50C transmitter is available with internal air blowers, or with central external blower, as ordered. Neither the modulator nor final amplifier tubes will be operating at near their maximum dissipation ratings at anytime during the operation of the BC-50C and, therefore, the air supply is far more than required with either system.

The output temperature limit of the transmitter is 57 degrees C. Operating at the maximum input temperature of 45 degrees C, the temperature rise will not exceed 12 degrees C in the output air stream from the transmitter.

It is estimated that approximately 17,000 BTU is radiated from the transmitter into the surrounding building. In order to accomplish this extremely low amount of heating effect, the BC-50C transmitter incorporates infrared reflector shields within the transmitter walls at points near power tubes which normally are hot spots in the transmitter. In the past few years Gates Radio Company has done much research on the use of these infrared reflectors and we have found that the temperature of a transmitter cabinet wall can be reduced by a phenomenal amount by installing these reflectors on the inside surface, near the heat generating sources mentioned. In addition to the infrared reflectors, to keep the cabinet surface temperatures down, the BC-50C transmitter uses refrigerator type seals on all the doors to prevent the flow of air out of the transmitter proper and into the surrounding room area. Besides these features, the construction of the cabinets and the layout of parts is in all cases handled to provide proper air distribution throughout the transmitter so that there are no so called "hot spots" that develop within the transmitter itself. This,

## BC-50C 50,000 WATT AM BROADCAST TRANSMITTER

therefore, allows us to quote the figure of approximately 17,000 BTU into the building.

It must be pointed out, however, that this figure is based on having exhaust ducts from the transmitter which are either of double wall construction, or which are well insulated so that the exhaust itself does not contribute to the temperature rise within the building.

The use of louvers in the exhaust duct above the transmitter can be employed in order to provide building heat during cold weather. These louvers must, of course, be tight fitting, in order to prevent air leakage during periods of air conditioning.

The new BC-50C transmitter unit occupies only 55 square feet of floor space, 11' wide by 5' deep. Heavy components, and the control and rectifier cubicle are located external to the transmitter unit. The control and rectifier cabinet occupies 9 square feet of floor space and can be located at any convenient place inside the building.

In addition to the compact design being offered in the Gates BC-50C, Gates' Engineers have painstakingly developed a completely dry rectifier system to provide all DC voltages needed in the transmitter. Careful and conservative design of the new rectifier system for the BC-50C indicates a long and trouble free life expectancy. Once again the power handling capability of this part of the transmitter is operating at less than 50% of manufacturers rating.

The following are technical specifications on the rectifiers employed:

- 10.5 SUPPLY employs 264 audio devices Type 50M7N rectifiers capable of 35 amperes output.
- 4.5 KV SUPPLY employs 132 audio devices Type 50 K7N rectifiers, capable of 25 amperes output.
- 3 KV SUPPLY employs 78 audio devices Types 50 K7N rectifiers, capable of 25 amperes output.
- 800 VOLT screen supply uses 24 IRC Type SD-94A rectifiers.
- 500 VOLT bias supply uses 40 IRC Type SD-94A rectifiers.
- 300 VOLT bias supply uses 12 IRC Type SD-94A rectifiers.



Rear view.

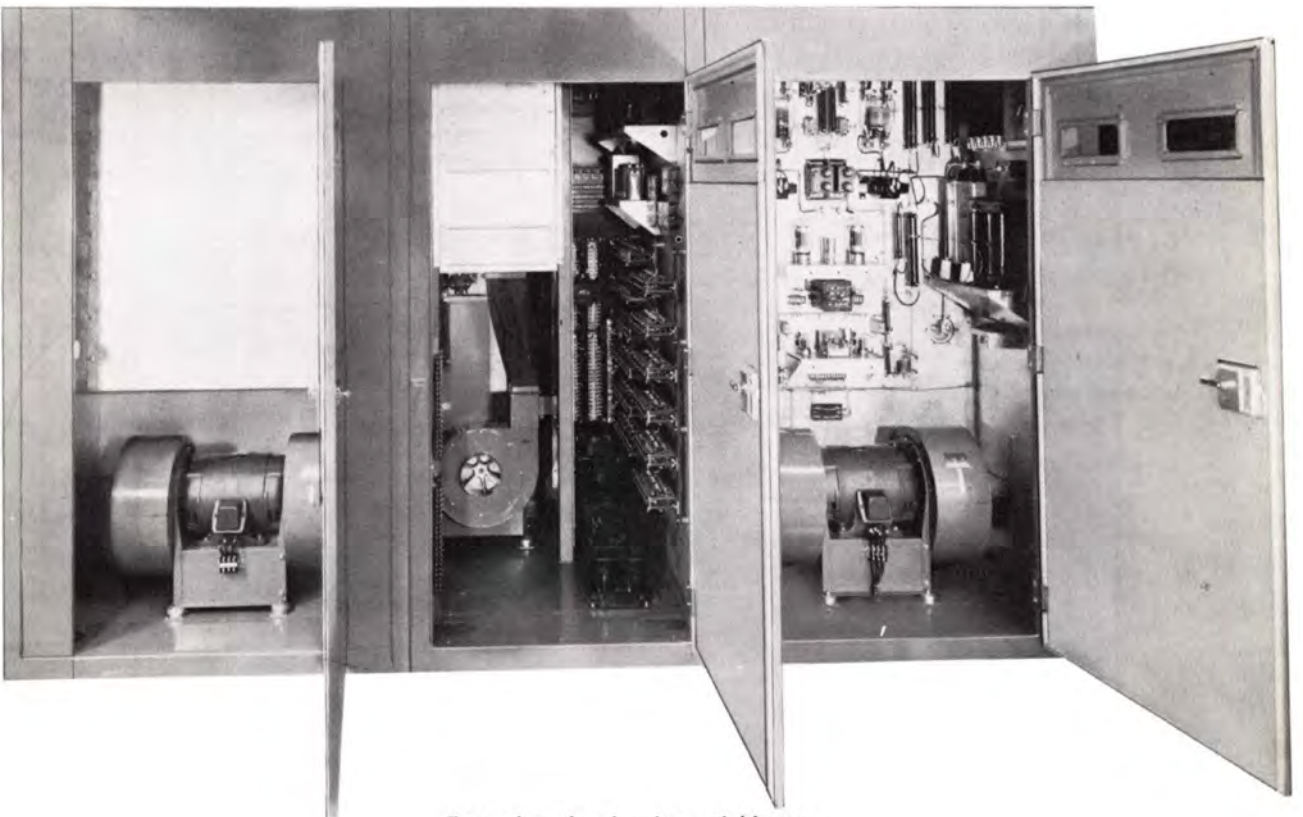

Rear view showing internal blowers.



# BC-50C 50,000 WATT AM BROADCAST TRANSMITTER

## SPECIFICATIONS

- POWER OUTPUT:** 55 KW maximum.
- RF OUTPUT IMPEDANCE:** 230 ohms unbalanced.  
(other impedances available on special order).
- RF RANGE:** 540 KC to 1600 KC (as ordered).
- FREQUENCY STABILITY:**  $\pm 5$  cycles.
- RF HARMONICS:** Suppression of harmonics meets or exceeds FCC requirement.
- AUDIO FREQUENCY RESPONSE:**  $\pm 1.5$  db 30-10,000 cycles.
- AUDIO HARMONIC DISTORTION:** 3% or less 50-7500 cycles at 95% modulation.
- AUDIO INPUT LEVEL:**  $\pm 10$  dbm  $\pm 2$  db for 100% modulation.
- AUDIO INPUT IMPEDANCE:** 600 ohms balanced.
- PRIMARY VOLTAGE:** 460 volts, 3 wire, 60 cycles, 3 phase.
- POWER FACTOR:** 90% or better.
- POWER CONSUMPTION:**  
89 KW at zero modulation  
99 KW at average modulation  
134 KW at 100% modulation
- CARRIER SHIFT:** 5% or less at 100% modulation.
- TUBES:** RF section — (2) 12BY7 oscillator and 1st amplifier (2) 6146 buffer (1) 6076 RF driver (2) 5891 final output.
- Audio section — (2) 6146 audio input, (2) 813 second audio, (2) 833A audio driver, (2) 5891 modulators.

**TOTAL NUMBER OF TUBES:** 15.

**TOTAL TUBE TYPES:** 6.

**SIZE:** 11' wide, 5' deep, 6 1/2' high (transmitter cabinets). See diagram for weights and dimension of external components.

**WEIGHT:** Approximately 18,000 lbs. net.  
Packed Weight — 22,900 lbs.

**CUBAGE:** 1555 with internal blowers.

**FINISH:** Medium gloss gray, two-tone.

## ORDERING INFORMATION

- Model BC-50C broadcast transmitter, 50,000 watts, with tubes, one crystal and oven ..... M-5913
- Spare 100% tube complement for above ..... TK-367
- FCC Tube complement (required FCC spares) ..... TK-368
- Spare crystal and holder ..... A-30866

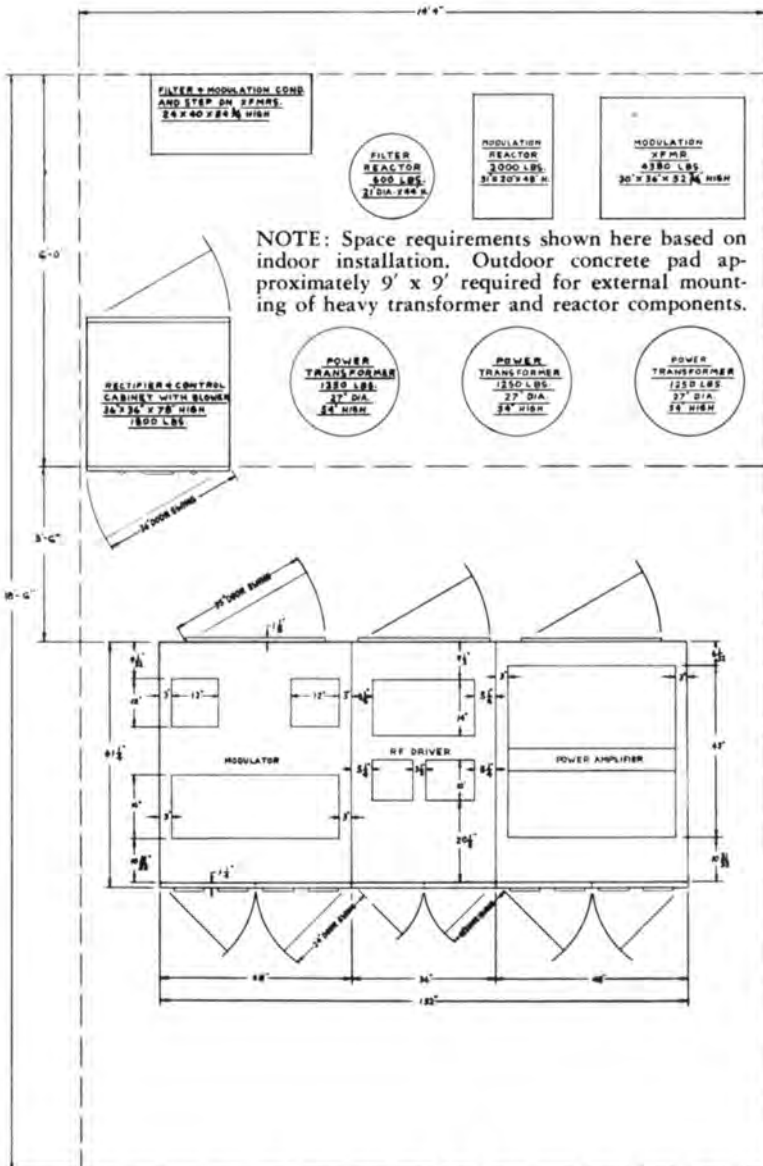

# 100,000 WATT AM BROADCAST TRANSMITTER

Model BC-100C

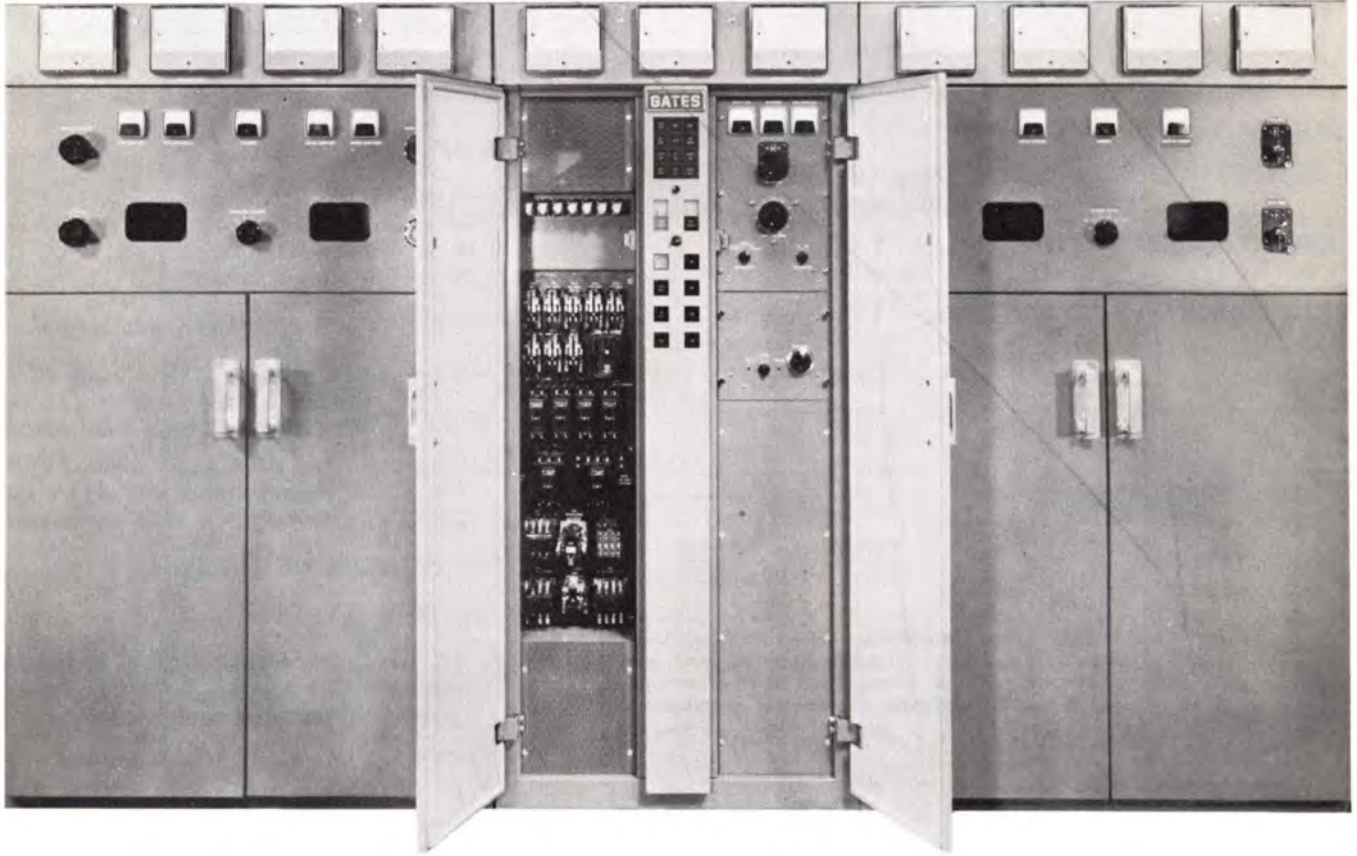

Front view showing supervisory and exciter cubicle.

The new Gates BC-100C 100 KW transmitter incorporating many new outstanding features such as compact size, silicon rectifiers, and only 15 tubes of 6 different types is the logical outgrowth of Gates' unparalleled experience in the manufacturing of broadcast transmitters.

**POWER AMPLIFIER CUBICLE:** The driver for the final amplifier consists of an Amperex type 6076 tube. Unit is cooled through the main circulating system by picking up air from the intake duct immediately below the transmitter. Driver amplifier stage itself is cooled through a separate blower.

**MODULATOR CUBICLE:** This cubicle houses two 5891 tubes which are accessible through the front doors. Cubicle is divided approximately 1/3 of distance from front to back with all lower level audio stages in back of divider. Audio input stage consisting of two 6146 tubes are mounted near the base of the cubicle. The second stage consisting of two type 813 tubes is mounted immediately above and the audio driver stage consisting of two

WL5736's in cathode follower driver circuit are mounted toward the top of the cubicle.

**CONTROL CIRCUIT:** The control system of the BC-100C transmitter is the most advanced type. All cubicle doors are interlocked and have automatic mechanical grounding switches. Cubicle service lights are controlled by separate switches on the door. The control switch circuit is arranged so that modifications and special applications may be made.

**COOLING SYSTEM:** The BC-100C is available with external blower unit only, providing more than the required amount of air. Refrigerator type seals are used on all doors to prevent the flow of air out of the transmitters. Proper air distribution is assured because of the BC-100C's unique layout — "hot spots" are eliminated.

**BC-100C AM BROADCAST TRANSMITTER**

Heavy components and the control and rectifier cubicles are located external to the transmitter unit, and can be located at any convenient place inside the building. Each control and rectifier cubicle occupies only 9 square feet of space. Heavy components are weatherproof.

A completely dry silicon rectifier system has been developed by Gates' Engineers to provide all DC voltages needed in the transmitters. Careful and conservative design of this new system for the BC-100C indicates long and trouble free life expectancy.

**SPECIFICATIONS**

**POWER OUTPUT:** 100,000 watts.  
**RF OUTPUT IMPEDANCE:** 230 ohms unbalanced.  
**RF RANGE:** 540 KC to 1600 KC.  
**FREQUENCY STABILITY:**  $\pm 5$  cycles.  
**RF HARMONICS:** Suppression of harmonics meets or exceeds FCC requirements.  
**AUDIO FREQUENCY RESPONSE:**  $\pm 1.5$  db 30-10,000 cycles.  
**AUDIO HARMONIC DISTORTION:** 3% or less 50-7500 cycles at 95% modulation.  
**AUDIO INPUT IMPEDANCE:** 600 ohms balanced.  
**PRIMARY VOLTAGE:** 460 volts, 3 wire, 60 cycles, 3 phase.  
**POWER FACTOR:** 90% or better.

**POWER CONSUMPTION:**  
 150 KW at zero modulation  
 168 KW at 30% average modulation  
 249 KW at 100% modulation  
**CARRIER SHIFT:** 5% or less at 100% modulation.  
**TUBES:** RF Section — (2) 12BY7 oscillator and 1st amplifier (2) 6146 buffers (1) 6076 RF driver (2) 5891 final output.  
 Audio Section — (2) 6146 audio input, (2) 813 second audio, (2) 5736 audio driver, (2) 5891 modulators.  
**TOTAL NUMBER OF TUBES:** 15.  
**TOTAL TUBE TYPES:** —6.  
**SIZE:** 14 ft. wide, 6 ft. deep, 6 ft. 5/8" high.  
**WEIGHT:** Approx. 22,914 lbs.  
**CUBAGE:** 1444.  
**FINISH:** Medium gloss gray.

**ORDERING INFORMATION**

Model BC-100C broadcast transmitter, 100,000 watts, with tubes and two crystals .....	M-5967
Spare 100% tube complement for above .....	TK-376
FCC Tube complement (required spares) .....	TK-377
Spare crystal and holder .....	A-30866

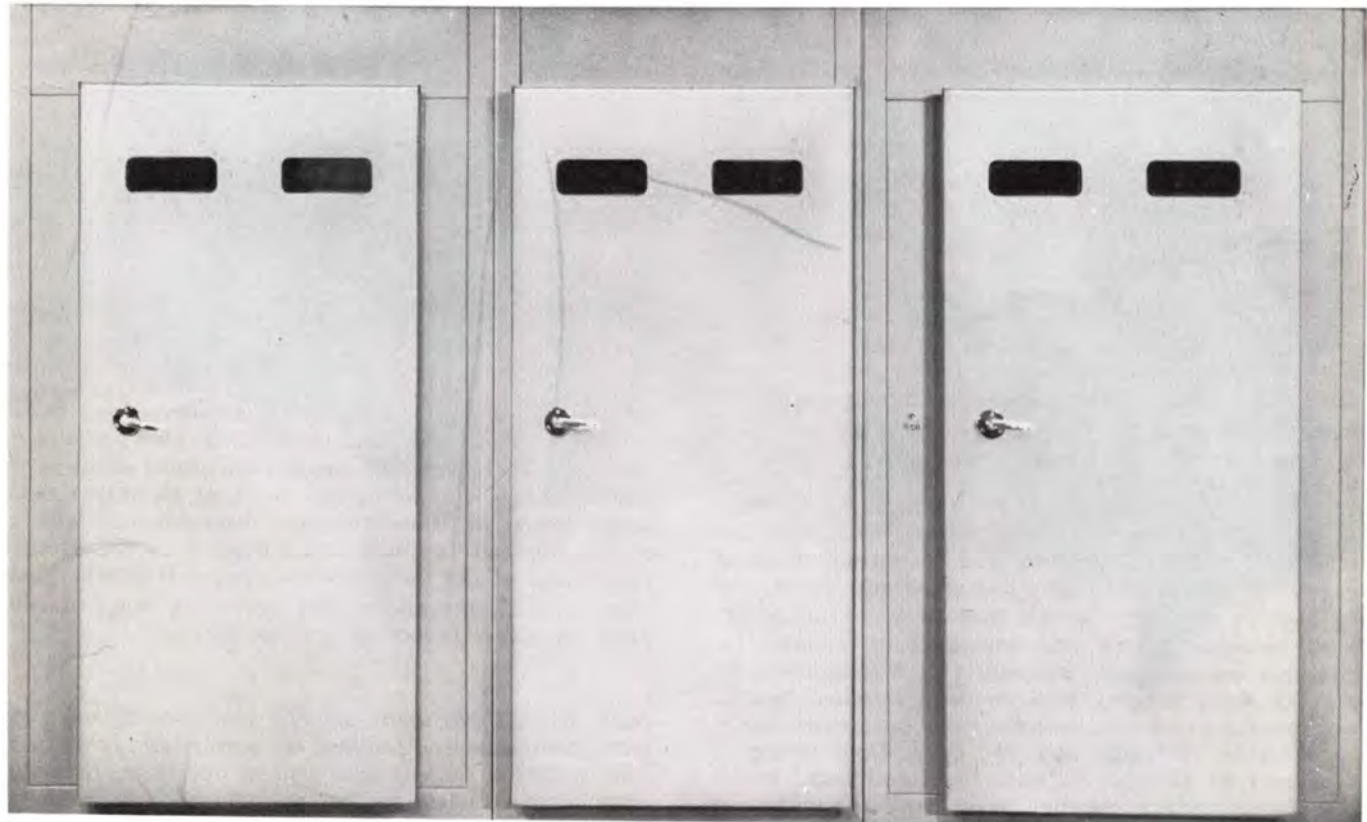

Rear View

# 20,000 WATT AM BROADCAST TRANSMITTER

Model BC-20B

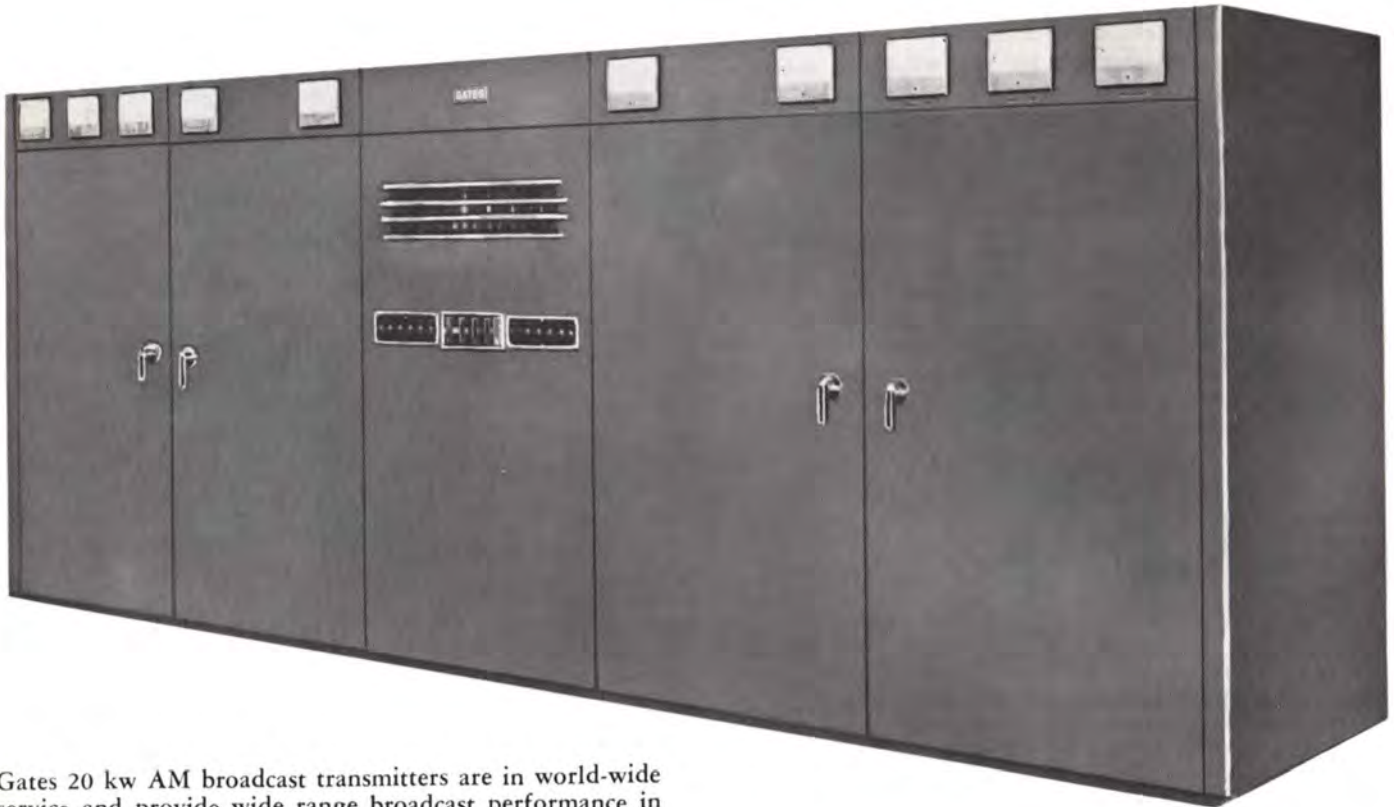

Gates 20 kw AM broadcast transmitters are in world-wide service and provide wide range broadcast performance in the standard broadcast band of 540-1600 Kc. Heavy commercial construction is combined with walk-in-to-service and modern up to date circuitry. Dual full wave, 3 phase, high voltage power supplies — one for the RF power amplifiers and the second for the modulators — exemplifies the conservative approach to BC-20B design. Tube complement utilizes thoriated single phase filament design in all power stages and tube cost is lower by a generous margin than any other transmitter in this power area.

**CONSTRUCTION.** Five cubicles join together to house the 20 kw radio frequency, audio frequency, protective and power supply units. The only external components are the two main power transformers, modulation transformer and reactor. These units are oil-filled and may be installed either in the building or on a protected platform outside the building. The transmitter is dead front, and all front doors may be opened without disrupting the carrier. No intercubicle cabling is required when installing. Each of the five cubicles is completely assembled and wired, and bolt speedily together. At the base of each cubicle are barrier terminal boards, and wiring of all cubicles together for an operating transmitter is accomplished by means of short jumpers between these terminal boards. Floor space, exclusive of external units mentioned above, is 210" wide, 78" high and 49" deep. Door swing of 40" should be allowed for both front and back. Finish is in hand rubbed medium gray with trimmings in chrome, brushed aluminum and anodized black.

**RADIO FREQUENCY SECTION.** Including oscillator, there are five radio frequency stages. All but the final amplifiers are self-neutralized. Dual crystals with closely held temperature controlled ovens excite a 6V6 oscillator with very low voltage applied for stability. IPA stages are 807, 6146 and dual 4-250A drivers. Four 3X2500F3 triodes comprise the pushpull power amplifier. Output coupling provides an impedance match from 40-270 ohms as ordered.

**MODULATOR SECTION.** Gates engineers have built a truly fine audio system into the BC-20B. Four audio stages are all pushpull. A special design transformer coupling system between the audio drivers and four 3X3000F1 modulators results in remarkably low distortion and wide response. Overall feedback is an adjunct to the excellent capabilities of the audio system without feedback. Modulation transformer and reactor are heavy duty, oil-filled units for either indoor or outdoor service.

**METERING.** No multi-metering is employed, and a full meter complement is supplied to measure all necessary circuits both for tune-up and general operation. Individual plate current meters are provided for each of the power amplifier and modulator tubes.

## MODEL BC-20B 20 KW BROADCAST TRANSMITTER

**RELAYS AND PROTECTION.** Gates engineers have provided protection to the point that no power consuming circuit of importance has been overlooked. Primary magnetic circuit breakers are inserted in all main primary lines. Individual supervisory overload relays are incorporated, not only for the transmitter main overload, but also for separate protection: exciter failure, air failure, RF driver, power amplifier, audio driver and modulators. Included are secondary relays for door interlock and air cooling interlock. Automatic condenser discharge relay switch immediately discharges the main filter capacitors when the door interlocks are disengaged.

**RECYCLING.** Automatic recycling relay controls automatically where the carrier is disrupted, and attempts to reset the carrier four times before remaining off. Many times the carrier interruption is caused by static discharges across the transmission line or tower base and this recycling feature is indispensable.

**POWER SUPPLIES.** Five major power supplies deliver plate and bias voltage to the BC-20B transmitter. Featured are the two complete high voltage supplies. One is used for the radio frequency power amplifier and the other for the modulators. The resulting almost perfect regulation is quickly recognized by the engineer. Likewise, in case of failure of one power supply, the remaining one can be fused in, operating the transmitter on reduced power until repairs are made. Each of these power supplies is full wave, three phase, six tube. Other individual supplies provide modulator bias voltage, power amplifier bias voltage and intermediate voltage for driver stages. All power supplies are generously protected by circuit breakers, overload relays, etc.

**PERFORMANCE.** Recognizing this transmitter will be used in every climate of the world, engineering attention was given to reliability under unusual conditions. Extra blower capacity in case of extreme heat is an example. The BC-20B will produce a carrier with a rich transmission quality, the result of low distortion, wide response, low noise and excellent stability.





**MODEL BC-20B SPECIFICATIONS**

**POWER OUTPUT:** Rated 20,000 watts. Capable 21,250 watts.

**RF OUTPUT IMPEDANCE:** 40-270 ohms.

**OUTPUT CONNECTOR:** Type Feedthru.

**RF RANGE:** 540 to 1600 Kc as ordered.

**FREQUENCY STABILITY:** 0.005% or better.

**FREQUENCY MONITOR COUPLING IMPEDANCE:** 50/70 ohms.

**MODULATION MONITOR COUPLING IMPEDANCE:** 50/70 ohms.

**RF HARMONICS:** Suppression of harmonics meets or exceeds FCC requirements.

**POWER REDUCTION:** Low power tune-up switch standard equipment.

**AUDIO FREQUENCY RESPONSE:**  $\pm 1\frac{1}{2}$  db, 50-10,000 cycles.

**AUDIO HARMONIC DISTORTION:** 3% or less, 50-7500 cycles at 95% modulation.

**AUDIO INPUT LEVEL:** +8 db  $\pm 2$  db for 100% modulation.

**AUDIO INPUT IMPEDANCE:** 600 ohms.

**PRIMARY VOLTAGE:** 230 volts, 3 wire, 50/60 cycles.

**POWER CONSUMPTION:** 37 Kw at zero modulation, 43 Kw at average modulation, 55 Kw at 100% modulation.

**CARRIER SHIFT:** 5% or less at 100% modulation.

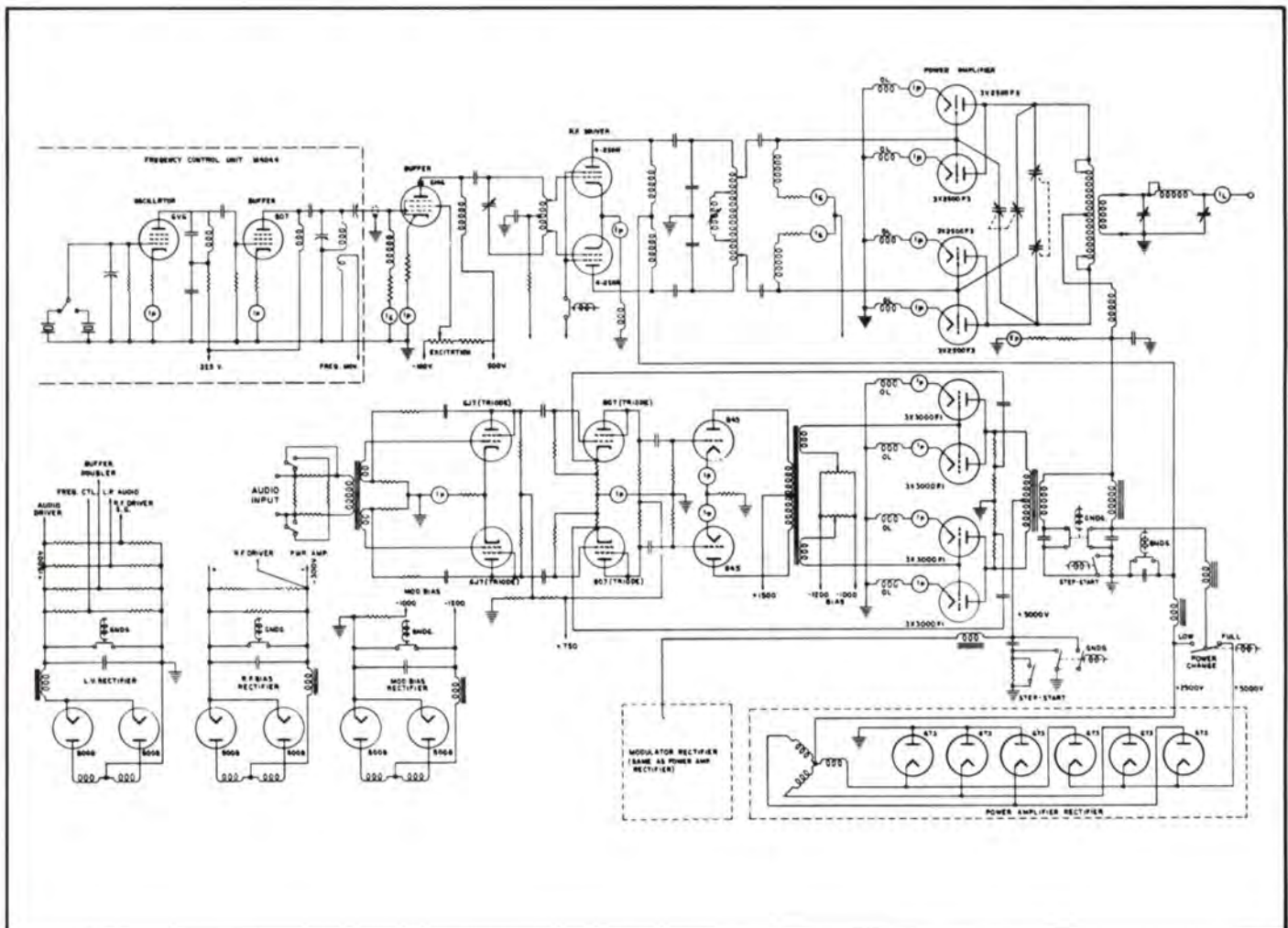

## MODEL BC-20B SPECIFICATIONS

**TUBES:** (Radio Frequency) 6V6 osc., 807 IPA, 6146 IPA, (2) 4-250A IPA, (4) 3X2500F3 power amplifiers.

(Audio Section) (2) 6J7 1st audio, (2) 807 2nd audio, (2) 845 3rd audio, (4) 3X3000F1 modulators.

(Power Supplies) (12) 673, (6) 8008.

**TOTAL NUMBER OF TUBES:** 37

**TOTAL TUBE TYPES:** 10

**SIZE:** 78" high, 210" wide, 49" deep. Front door swing, 40". Floor space external transformers, 10' x 2 1/2'.

**WEIGHT:** 19,500 lbs. net, 23,000 lbs. packed.

**CUBAGE:** 720 cubic feet.

**FINISH:** Finish is in hand rubbed medium gray with trimmings in chrome, brushed aluminum and anodized black.

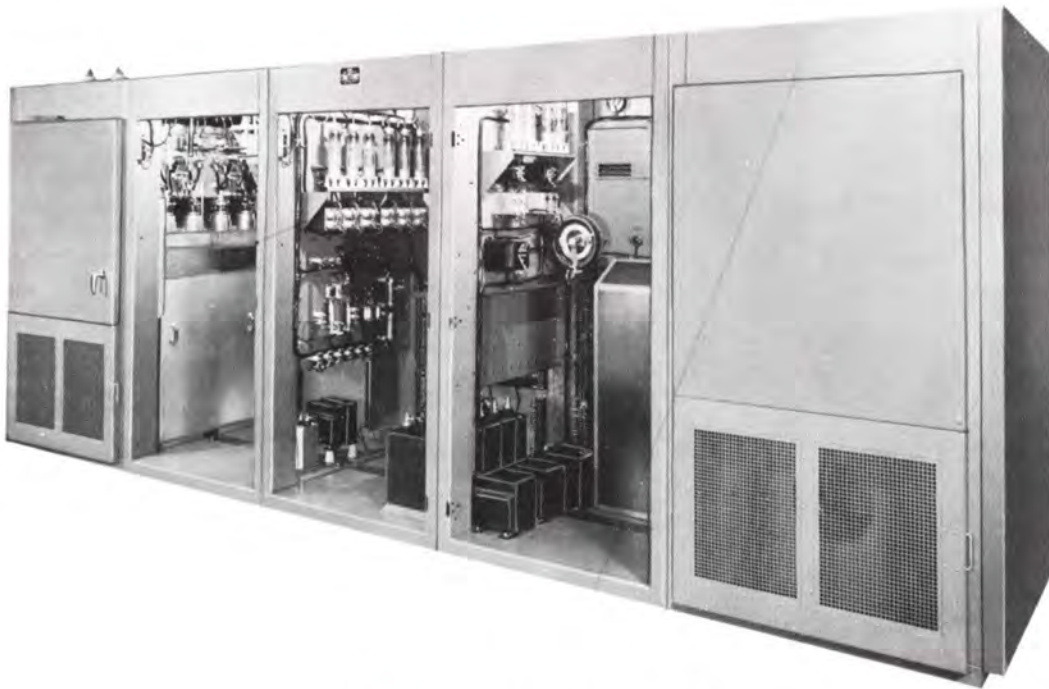

### ORDERING INFORMATION

AM broadcast transmitter, 20,000 watts, with tubes, one crystal and oven .....	BC-20P
Spare 100% tube complement for above .....	TK-229
FCC tube complement (required FCC spares) .....	TK-361
Spare crystal and oven .....	JK-57M

# 10,000 WATT AM BROADCAST TRANSMITTER

Model BC-10P



The Gates BC-10P 10 KW broadcast transmitter has been designed with emphasis on wide frequency response to satisfy the discriminating listener, less floor space to permit a power jump in the same building facilities and low operating cost via reliability for lesser maintenance and lowest tube replacement cost.

**CONSTRUCTION:** BC-10P is completely self-contained in three cubicles each 24" wide, 36" deep and 78" high. The three units, when joined as a single assembly, make a unit 73½" long, 39½" deep and 78" high. These three cubicles contain as separate units, a power supply, modulator and radio frequency unit. As there are no mechanical interconnections such as tuning drives, bus-work, supporting frames, etc., the cubicles may be arranged in respect with each other in any sequence as best suits the installation. With additional end bells, the cubicles may be installed as separate units. Those increasing power or replacing existing equipment will note the small floor

space area. Back doors are of the latch-on type and no door swing allowance is necessary. Even older model 1 KW transmitters often consumed this area. Installation of BC-10P may be made in nearly all buildings housing lower powered equipment at the present time.

**HARMONIC RADIATION:** Harmonic radiation is realistically reduced by constructing the entire radio frequency section within a heavy aluminum enclosure. This is known as elimination of cabinet radiation, otherwise serious in higher powered transmitters. The tank circuit includes a full Pi network, coil tuned and void of variable capacitors. It is believed no other 10 KW transmitter will equal the low potential harmonic radiation of the BC-10P transmitting plant.

**FIDELITY:** Fidelity of the BC-10P transmitter extends to 15,000 cycles. Where adjacent channel conditions will not permit 15,000 cycle response, this may be reduced to

## MODEL BC-10P 10 KW AM BROADCAST TRANSMITTER

meet FCC requirements. Low distortion is even more important to high fidelity than wide frequency response. The use of cathode follower audio drive, over-all audio feedback and over-powered RF grid drive assures day to day low distortion without exhaustive alignment and balancing. Not to be overlooked is the use of low impedance modulator tubes where transformer ratio between modulator plates and Class C amplifier impedance is near unity and conducive to best audio transfer at high efficiency and lower distortion.

**COOLING:** Many factors are associated with reliability. Cooling is the most important. The BC-10P transmitter incorporates individual cooling for each of the three cubicles comprising the entire equipment. Instead of one master blower, as in older models, where hot air could

be spilled into another part of the transmitter, BC-10P has three sealed separate air chambers, each cooled separately. In this way, all air from the filtered intake at the base of each cubicle is sent through to the top exhaust point quite like the updraft of a flue. Components in the RF section are cooled with the tubes, remembering the RF section is an aluminum chamber. There is no cooler operating 10 kilowatt than the Gates BC-10P.

**TUBES AND LIFE.** Though the BC-10P has the lowest cost tube complement of any 10 KW broadcast transmitter, of much greater value is the long tube life and tube interchangeability. Major recognition must be given to interchangeability of RF power amplifier and modulator tubes in both maintaining highest performance standards and ability to obtain the last ounce of tube life through interchangeability. But again, the masterful cooling system plays a major part in tube life. The torrent of BC-10P air develops the longer tube life from the lowest cost tube complement.

**REMOTE CONTROL:** Whether remote control is attended or unattended, the engineer should note the 100% relay complement and absence of circuit breakers in control circuits. To adapt to remote control is as simple as making the connections. No major mechanical alterations or addition of control relays is necessary if remote control is in your operating picture.

**OSCILLATOR.** New vacuum mount ovenless crystals are used with pin-point accuracy. There is provision for two.

**RF POWER PLANT.** Single ended dual 3X2500F3 air cooled power stage feeds full-fledged Pi network. Tank and load tuning by variable coils. Optional RF ammeter in direct electrical circuit visible through port. Dual vacuum mount crystals excite untuned Colpitts oscillator. 6146 IPA and 4-250A tetrode drives 3X2500F3 power amplifiers. Maximum output power of 10,600 watts accommodates most complicated multi-tower phasor. Complete RF section is in right cubicle.

**AUDIO:** Four push-pull stages with overall feedback. Dual 3X2500F3 modulators interchangeable with RF power amplifier. Audio driver is cathode follower design. Modulator/audio section in left cubicle.

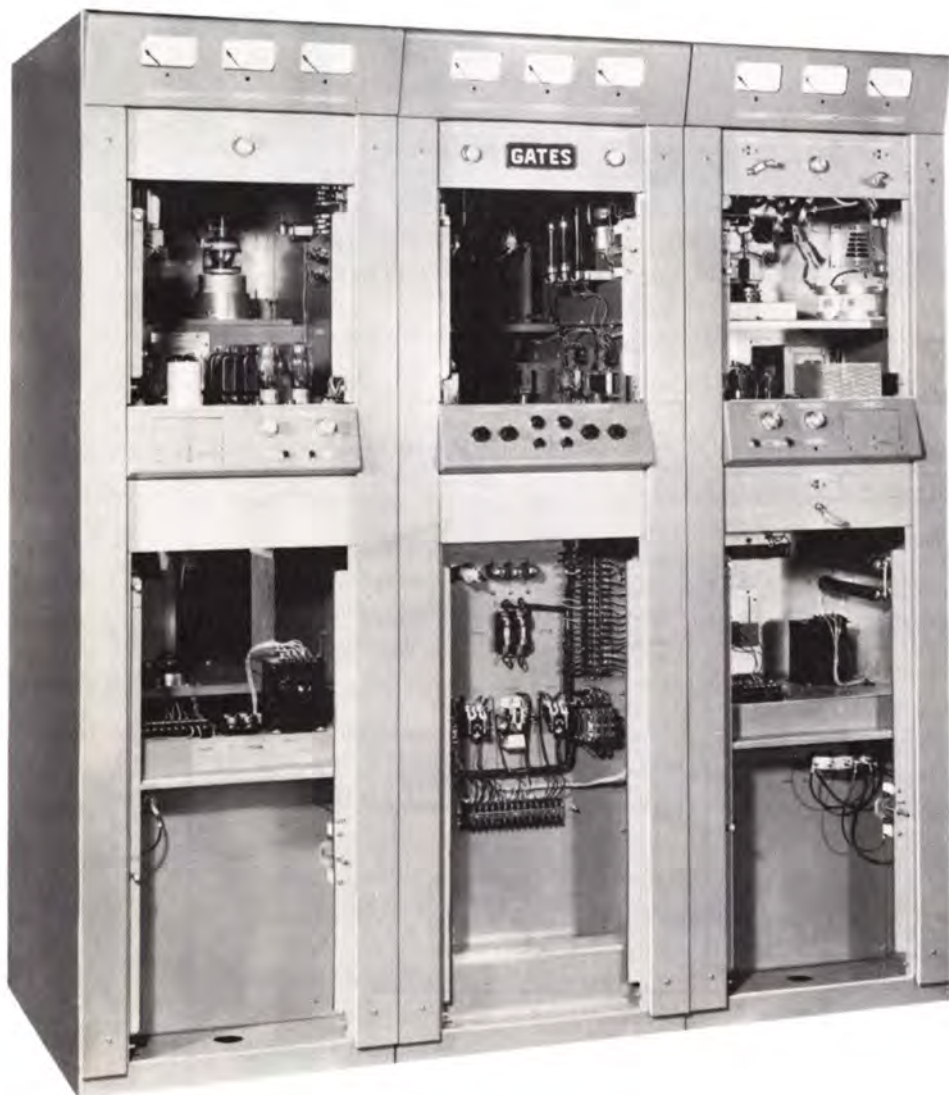

## MODEL BC-10P BROADCAST TRANSMITTER

**POWER SUPPLIES.** Four in all, 3 low voltage supplies plus 3 phase full wave (six 673 tubes) main power supply.

**RECYCLING.** In case of overload, transmitter automatically recycles and places itself back on air. A rapid succession of overloads removes the high voltage. For remote control, this feature is indispensable.

**PROTECTIVE DEVICES.** Full overload, start, stop and interlock protection of relay type. No electrical or mechanical alterations necessary for adapting to remote control.

**CONELRAD.** As each radio frequency cubicle is independent to the over-all transmitter, a second RF cubicle for Conelrad may be purchased at less cost than a separate Conelrad transmitter. Simple instantaneous relay switching to Conelrad.

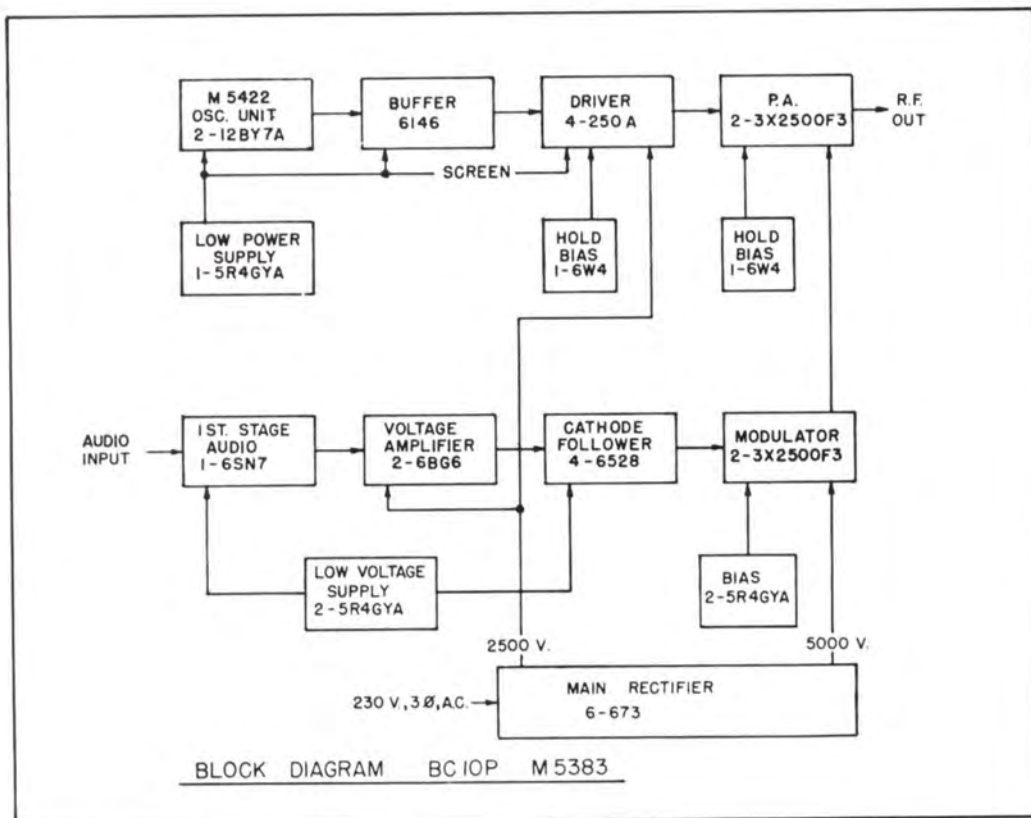

**MODEL BC-10P SPECIFICATIONS**

**POWER OUTPUT:** Rated 10,000 watts.  
Capable 10,600 watts.

**RF OUTPUT IMPEDANCE:** 40-270 ohms, as ordered.

**OUTPUT CONNECTOR:** Type Feed thru.

**RF RANGE:** 535 Kc to 2000 Kc as ordered.

**FREQUENCY STABILITY:** ±10 cycles.

**FREQUENCY MONITOR COUPLING IMPEDANCE:** 50/70 ohms.

**MODULATION MONITOR COUPLING IMPEDANCE:** 50/70 ohms.

**RF HARMONICS:** Suppression of harmonics meets or exceeds FCC requirements.

**POWER REDUCTION:** Reduces to 2500 watts by switch control.

**AUDIO FREQUENCY RESPONSE:** ±1½ db, 30-10,000 cycles at 95% modulation. ±1½ db, 30-15,000 cycles under typical programming conditions.

**AUDIO HARMONIC DISTORTION:** 3% or less 50-7500 cycles at 95% modulation.

**AUDIO INPUT LEVEL:** 0 db ±2 db for 100% modulation.

**AUDIO INPUT IMPEDANCE:** 600/150 ohms at 0 dbm.

**PRIMARY VOLTAGE:** 230 volts, 3 phase 50/60 cycles.

**POWER CONSUMPTION:** 18 Kw at zero modulation, 21 Kw at average modulation, 26 Kw at 100% modulation.

**CARRIER SHIFT:** 3% or less at 100% modulation.

**TUBES:** (2) 12BY7A osc./isolation buffer, 6146 IPA, 4-250A RF driver, (2) 3X2500F3 RF power amplifiers, (5) 5R4GYA LV power supply rectifiers,

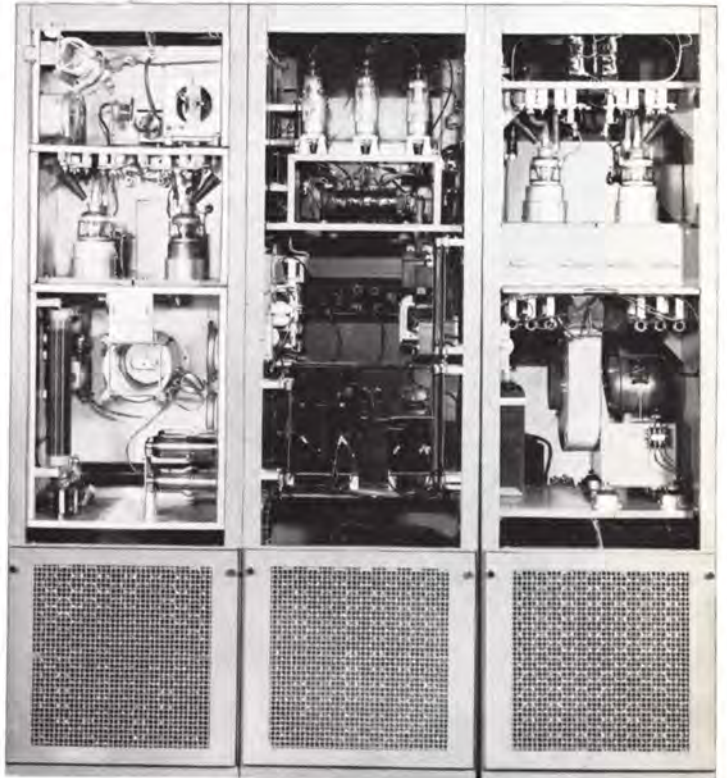

(6) 673 HV power supply rectifiers, (2) 6W4 hold bias rectifiers, 6SN7 first audio, (2) 6BG6 second audio, (4) 6528 cathode follower driver amplifiers, (2) 3X2500F3 modulators.

**TOTAL NUMBER OF TUBES:** 28.

**TOTAL TUBE TYPES:** 11.

**SIZE:** 78" high, 73½" wide, 39½" deep.

**WEIGHT:** 2650 lbs. net. 3400 lbs. packed.

**CUBAGE:** 198 cubic feet.

**FINISH:** Base color: dark industrial gray, with second color in semi-gloss medium gray. Control knobs in anodized aluminum and kurlled for firm gripping.

**ORDERING INFORMATION**

AM Broadcast transmitter, 10,000 watts, with tubes, one crystal and oven .....	BC-10P
Spare 100% tube complement for above .....	TK-314
FCC tube complement (required FCC spares) .....	TK-315
Spare crystal and holder .....	A30866

**NOTE:** BC-10P also available with Silicon Rectifiers.

# 5000 WATT AM BROADCAST TRANSMITTER

Model BC-5P-2



The Gates BC-5P-2 transmitter offers a more reliable service and increased frequency stability through the use of the Gates M-5422 oscillator (with vacuum crystal holders that do not require crystal heaters). Larger filament rheostats have been added to give greater range of filament voltage control. This Gates 5 kilowatt transmitter also has new and improved wiring techniques which give the added advantage of extra voltage and current rating, neatness, and numbering for assistance in tracing out cables and circuits. Everyday reliability is the result of conservative component specifications and a 3-cabinet cooling system replacing the single blower. Gates BC-5P-2 has the advantage of exclusive styling, which includes new and improved door design, air filter,

mounting and improved accessibility for servicing. A 100% air cooled RF power plant sets the pace by cooling all the important radio frequency components instead of only the power tubes. Lower tube cost is twofold in both the lowest dollar cost for a complete tube complement and longer tube life through the advanced cooling system and high efficiency.

**RADIO FREQUENCY SECTION:** As shown in the rear view, the RF section is the left cubicle. As each cubicle is mechanically independent of the other, the RF cubicle could also be to the right or completely separate. In this way, the RF section may be placed exactly convenient to the desired phasor location or transmission line exit from the building. Headed by dual vacuum type crystals requiring neither oven, thermometer nor thermostat, the

**BC-5P-2 5000 WATT AM BROADCAST TRANSMITTER**

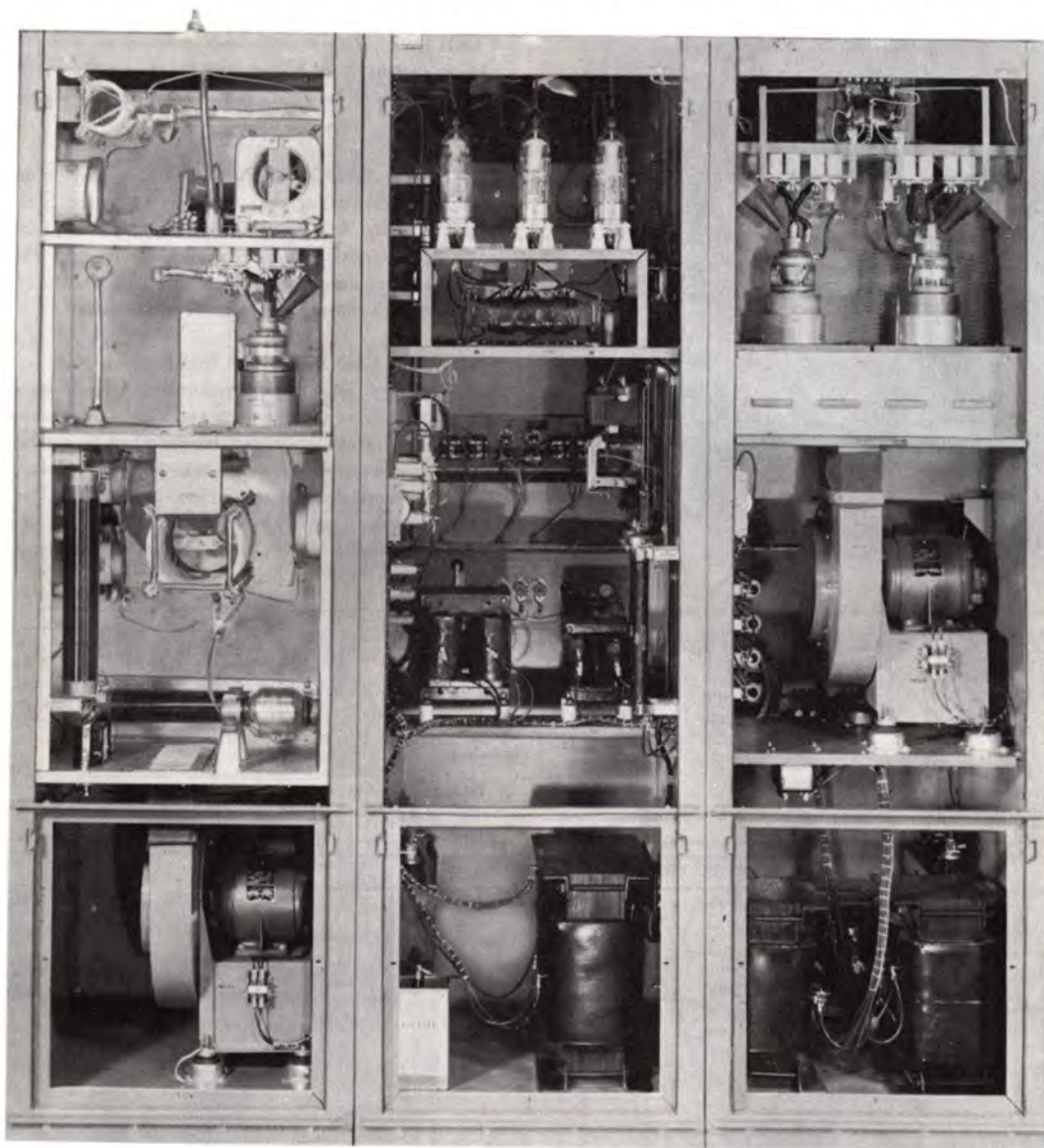

four RF stages are self-neutralized except the triode 3X2500F3 power amplifier. The final tank plus the complete 2-coil Tee output coupling network is variable coil tuned, eliminating chance for arc over. The squirrel cage blower at the bottom cools this cubicle only and places every major component under forced air.

**AUDIO SECTION:** This cubicle can be moved from left to right, too. A second independent cubicle is forced air cooled by another blower identical to that in the RF cubicle. Four stages, all push-pull, feature an ultra linear driver amplifier, known world-wide as the ultimate in low distortion audio. Modulators are Class B 3X2500F3 tubes and are interchangeable with the RF power amplifier. Over-all feedback from the modulator plates to the input stage grids, adds to the excellent performance possible even without feedback.

**POWER SUPPLIES:** Five power supplies include (a) the six tube, three phase, full wave, 5000 volt, high voltage supply, (b) audio driver supply, (c) RF driver supply, (d) modulator bias

supply, and (e) RF bias supply. All are well regulated and excellently filtered power supplies of the highest order. 100% silicon rectifiers optional.

**PROTECTIVE:** A complete relay complement for overload, start-stop, interlock and condenser discharge. Air pressure switches replace the older damper type interlock to supply 100% protection in case of failure.

**REMOTE CONTROL:** The use of relays in the protective system is a natural adjunct for easy attachment of remote control. As circuit breakers are not used in major control circuits, alterations, either mechanical or electrical, are negligible. Remote control may be installed without involved wiring changes. Circuits to be affected are provided with extra terminals.

**RECYCLING:** In case of overload the transmitter automatically places itself back on the air until overload has been determined permanent, an indispensable feature for both attended and unattended operation.



**BC-5P-2 5000 WATT AM BROADCAST TRANSMITTER**



**COOLING:** RF cubicle and modulator cubicles have individual shock mounted impeller type blowers. Power supply cubicle has exhaust fan in top. All motors are single phase for easy maintenance.

**STYLING AND CONSTRUCTION:** Top meter panels tilt forward and down for ease in vision. Center control panels tilt forward and up for ease in handling. Front panels of semi-hinged type are instantly removable for servicing. Three back doors of latch-on type conserve space. Three cleanable air intake filters are removable without turning off transmitter.

**INBUILT CONELRAD:** Inbuilt conelrad system is available with all new BC-5P-2 transmitters. All components are housed in RF cubicle thus eliminating extra cubicle previously used. Switching to and from conelrad frequencies is accomplished by merely pushing a button for each function. Is easily adaptable to unattended remote control operation, as the broadcaster simply changes tower coupling unit to conelrad frequencies. Output on conelrad frequencies will be the same as on regular frequency.

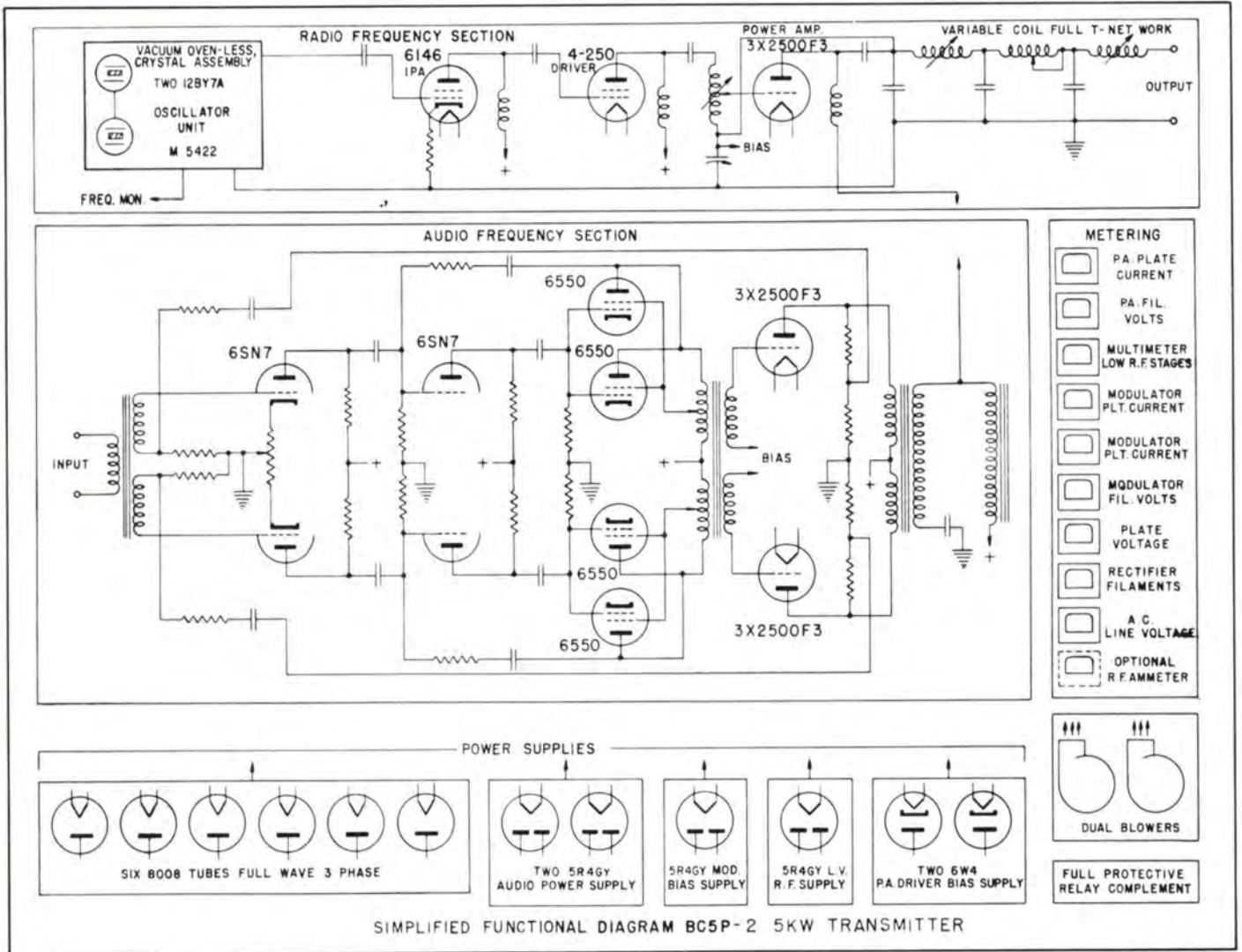

**BC-5P-2 VERSATILE FLOOR PLANS**

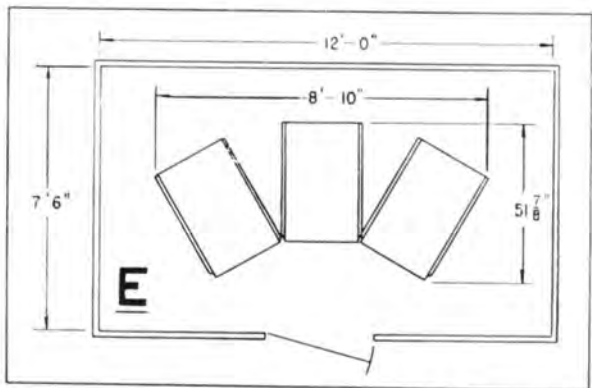
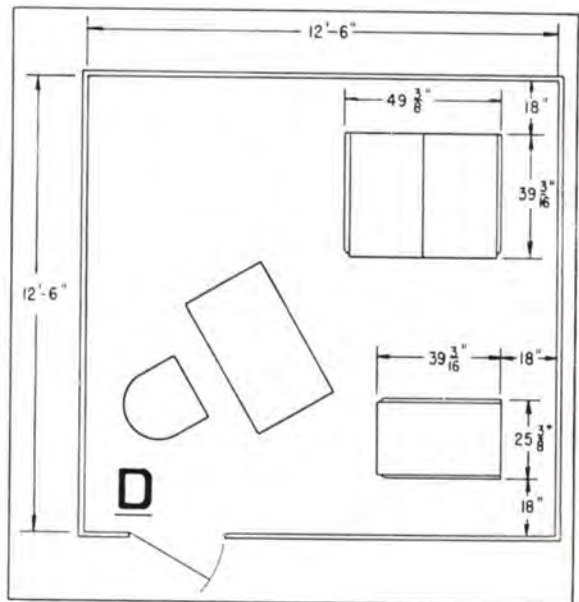
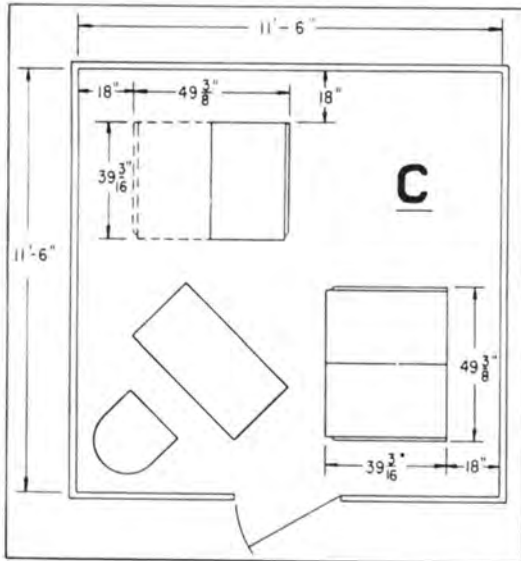
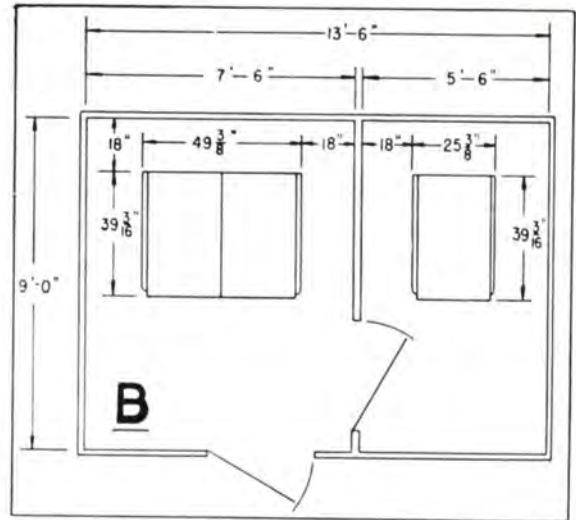
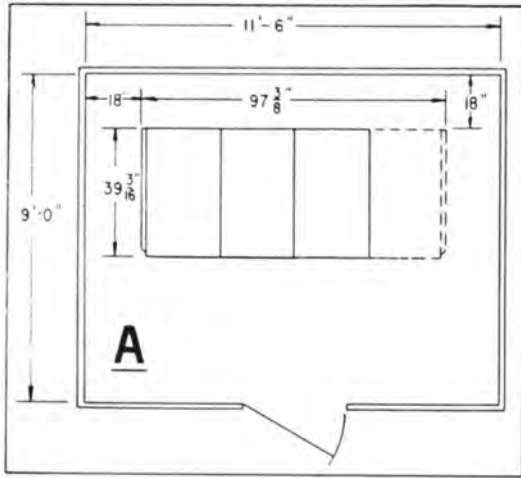

**FIG. A:** Three cubicles comprise the transmitter. The fourth (dotted line) may be either a phasor or extra RF cubicle for Conelrad or standby. The RF cubicle and phasor may be to the left or right side, as preferred. Note very small floor area even with extra cubicle added.

**FIG. B:** Often when increasing power to 5 KW the transmitter building is too small. As each cubicle in BC-5P-2 is independent, they may be moved around as desired. Here, one of the BC-5P-2 cubicles has been placed in the tool or bunk room. This may also be a simple lean-to added to the present building.

**FIG. C:** In this arrangement a square building accommodates 2 cubicles on one side of the room and 2 cubicles at 90° angle. In this way, a complete transmitter plus phasor will install in the most cramped quarters, leaving ample room for a rack or audio, monitor and remote control equipment. As both front and back doors are of latch-on type, provision for door swing is unnecessary.

**FIG. D:** Another method of BC-5P-2 installation. Floor space, in this arrangement, is kept to an absolute minimum. Actually most 250 watt buildings will accommodate this arrangement.

**FIG. E:** Here is something different in 5 KW floor arrangements. Only Gates design permits a semi-horseshoe floor plan. Only Gates has independent cubicle design where cooling and electrical construction is complete in each cabinet or cubicle and wire jumpers between cubicles is the only necessity for complete operation.

## BC-5P-2 5000 WATT AM BROADCAST TRANSMITTER

### SPECIFICATIONS

- |   |  |
|---|--|
| <p><b>POWER OUTPUT:</b> Rated 5000 watts.<br/>Capable 5600 watts.</p> <p><b>RF OUTPUT IMPEDANCE:</b> 40-370 ohms.</p> <p><b>OUTPUT CONNECTOR:</b> Feed thru insulator.</p> <p><b>RF RANGE:</b> 535-2000 Kc, as ordered.</p> <p><b>FREQUENCY STABILITY:</b> <math>\pm 5</math> cycles.</p> <p><b>FREQUENCY MONITOR COUPLING IMPEDANCE:</b><br/>50/70 ohms.</p> <p><b>MODULATION MONITOR COUPLING IMPEDANCE:</b> 50/70 ohms.</p> <p><b>RF HARMONICS:</b> Suppression of harmonics meets or exceeds FCC requirements.</p> <p><b>POWER REDUCTION:</b> Carrier reduction to approximate 1 kw.</p> <p><b>AUDIO FREQUENCY RESPONSE:</b> <math>\pm 1\frac{1}{2}</math> db, 30-12,000 cycles. Where ordered, transmitter will be supplied to maximum high frequency response of 7500 cycles to meet new FCC regulations for lower sideband radiation.</p> <p><b>AUDIO HARMONIC DISTORTION:</b> 3% or less, 50-7500 cycles at 95% modulation.</p> | <p><b>AUDIO INPUT LEVEL:</b> -5 db <math>\pm 2</math> db for 100% modulation.</p> <p><b>AUDIO INPUT IMPEDANCE:</b> 600/150 ohms at -5 dbm.</p> <p><b>PRIMARY VOLTAGE:</b> 230 volts, 3 phase, 50/60 cycles.</p> <p><b>POWER CONSUMPTION:</b> 10.2 KW at zero modulation, 11.5 KW at average modulation, 15 KW at 100% modulation.</p> <p><b>CARRIER SHIFT:</b> 3% or less at 100% modulation.</p> <p><b>TUBES:</b> 12BY7 osc., 12BY7 1st amp., 6146 buffer, 4-250A RF driver, 3X2500F3 power amplifier, 6SN7 1st audio, 6SN7 2nd audio, (4) 6550 audio driver, (2) 3X2500F3 modulator, 6W4 driver hold bias rectifier, 6W4 PA hold bias rectifier, (2) 5U4G audio plate rectifier, 5U4G modulator bias rectifier, (6) 8008 main rectifier.</p> <p><b>TOTAL NUMBER OF TUBES:</b> 24.</p> <p><b>TOTAL TUBE TYPES:</b> 9.</p> <p><b>SIZE:</b> 78" high, 73<math>\frac{1}{2}</math>" wide, 39<math>\frac{1}{2}</math>" deep.</p> <p><b>WEIGHT:</b> 2186 lbs. net. 2970 lbs. packed.</p> <p><b>CUBAGE:</b> 198 cubic feet.</p> <p><b>FINISH:</b> Base color medium dark glossgray, hand rubbed with second tone in medium light gray. Control knobs in anodized aluminum and knurled for firm gripping.</p> |
|---|--|

### ORDERING INFORMATION

Model BC-5P-2 broadcast transmitter, 5000 watts, with tubes, and one crystal .....	M-5565
Spare 100% tube complement for above .....	TK-321
FCC tube complement (required FCC spares) .....	TK-322
Conelrad adaptor kit installed in transmitter .....	M-5969
Spare crystal and vacuum holder .....	A-30866

## BC-5P-2 5,000 WATT AM TRANSMITTER WITH SILICON DRY RECTIFIERS

**BC-5P-2 5 KW TRANSMITTER:** Silicon rectifiers are offered as an option with the BC-5P-2 transmitter. Exhaustive tests performed by Gates and data available from all dry rectifier manufacturers indicates that silicon rectifiers are the most reliable for the exacting requirements of broadcast service. They are used in all D.C. power supplies, both high and low voltage. Conservatively rated 25 ampere units are used in the 5000 V supply, and plug-in type silicon rectifiers are used in the low voltage and bias supplies.

The Gates BC-10P transmitter, 10,000 watt companion model to the BC-5P-2 transmitter, is also available with silicon rectifiers.

**BC-50C 50 KW BROADCAST TRANSMITTER:** Silicon rectifiers are used in all D.C. power supplies in the new Gates BC-50C 50,000 watt transmitter. Every precaution has been taken for protection of silicon rectifiers in this transmitter, including ultra conservative power rating and instantaneous trip circuit breakers, which have faster action than the silicon rectifier specifications require. Forced air cooling is used to insure operating temperatures well below the ambient temperature specifications.

**BC-1T 1 KW TRANSMITTER:** Silicon rectifiers are offered as an option in this transmitter, and are used in all D.C. power supplies, both high and low voltage. The BC-500T 500 watt transmitter and the BC-250T 250 watt model are also available with silicon rectifiers.

### ADVANTAGES OF SILICON RECTIFIERS:

- Compact size
- Long life
- Allows remote control operation of transmitter in unheated building
- Eliminates need for rectifier filament power and reduces power consumption of transmitter
- Allows plate voltage to be applied to transmitter immediately without waiting for rectifier tube to warm up
- Simplifies transmitter maintenance

Pricing information on all Gates transmitters equipped with silicon rectifiers available on request.



BC-5P-2 5000 Watt AM  
Transmitter with Silicon Rectifiers

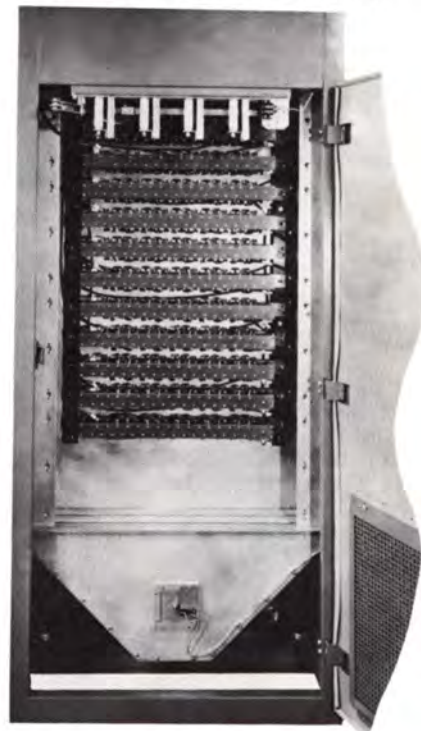

Dry Rectifier Cubicle,  
BC-50C 50 KW Transmitter

# 1000 WATT AM BROADCAST TRANSMITTER

Model BC-1T

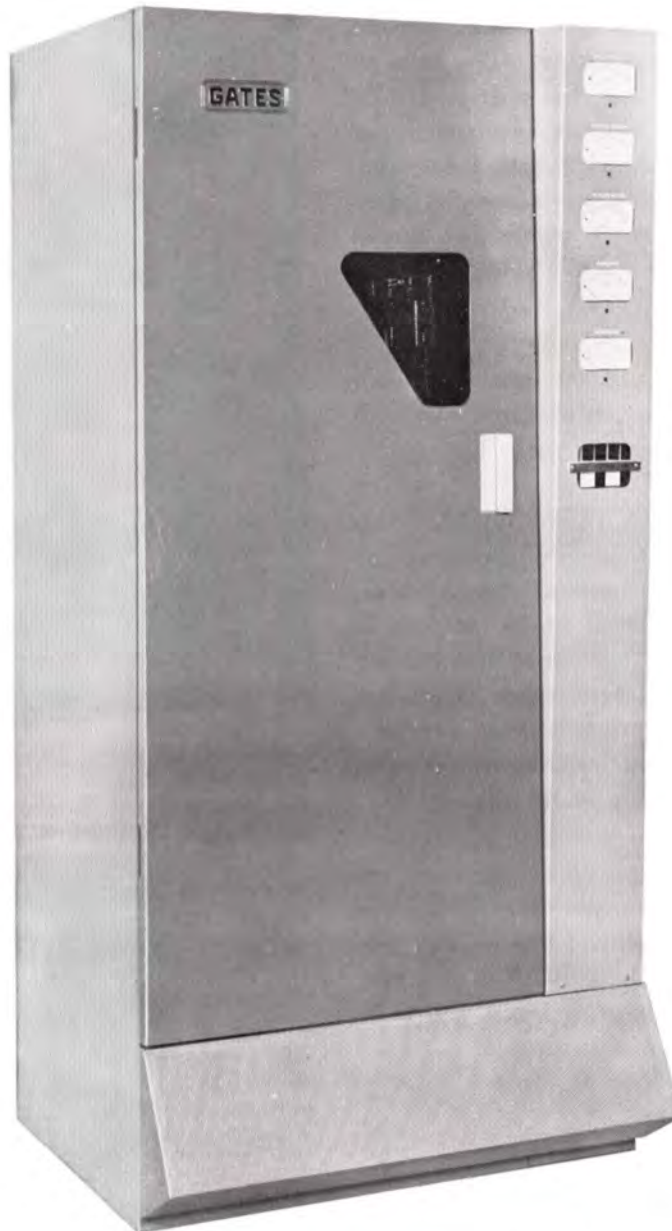

Listenability is defined as that unusual rich quality that holds listeners to BC-1T dial spots. The combination of cathode follower, a modulation system that modulates both the Class C and RF driver amplifiers and over-all feedback, results in a new distortion low. Prototype BC-1T transmitters actually produces 50 cycle distortion as low as one-half of one percent. As a result, production models are easily held in the one percent range. The frequency response has been gently tilted up to 50 and 10,000 cycles to balance response losses often found in other parts of the over-all broadcasting system.

**CONSTRUCTION.** Transmitter is in a heavy 16 gg. steel cabinet, rigidly reinforced and attractively styled. Meter panel slopes forward for ease in observation and gives the added touch for today's modern radio age. A full length front door is held closed by mag-

netic door catches. Behind the front door is a full length perforated grill, interlocked for personnel protection but affording full view of components from top to bottom, with the transmitter in operation. This perforated grill may be removed in seconds by means of snap locks. All operating controls are instantly accessible by opening the door. At the bottom front is a full width filtered air intake grill. Exhausted air is brought out of the top by dual exhaust fans. Though the back of the transmitter is quickly removable, there is no need to do so as servicing is accomplished from the front. With this exclusive design, the transmitter may be located near or against the wall with great savings in floor space and the convenience of more usable room in the transmitter building. The cabinet side is also removable. Though the need is unlikely, every part may be reached down to the smallest resistor, in seconds.

## MODEL BC-1T 1000 WATT AM BROADCAST TRANSMITTER

**INBUILT DUMMY ANTENNA.** For off air testing, the BC-1T includes an inbuilt dummy antenna that will handle the full 1000 watts power 100% modulated. For the new station yet to go on the air, complete tests may be made even before the tower is up, often saving days of time. The station already on the air will find this feature indispensable. Regular maintenance becomes a pleasure. Testing may be done any time instead of waiting until wee hours after midnight. A light indicates when the dummy antenna is in use to omit possibility of leaving dummy antenna in the circuit for regular broadcasting.

**PRINTED WIRING.** Printed wiring is uniformity. Wiring is always errorless. More important is reliability. No wires to chafe or deteriorate in the more critical circuits of the transmitter. Do not confuse printed wiring with printed circuit. In BC-1T there are no

printed components—only printed wiring. The oscillator-IPA unit, RF driver section, audio amplifier section and feedback ladder are all printed wiring. In maintenance and point to point checking, the engineer will not overlook the tremendous advantage of printed wiring with no wires or parts stacked on top of each other.

**LOCAL REMOTE CONTROL.** Handled entirely by relays. No hard to adapt circuit breakers are employed. Terminals are incorporated for attachment of filament on-off and high voltage on-off for remote control. Overload relays and time delay relays are all of the type and circuit which assures positive protection and easy adaptation to remote control.

**COOLING.** Across the bottom front is a full width grill behind which is a replaceable air filter. In the top of the cabinet are two,

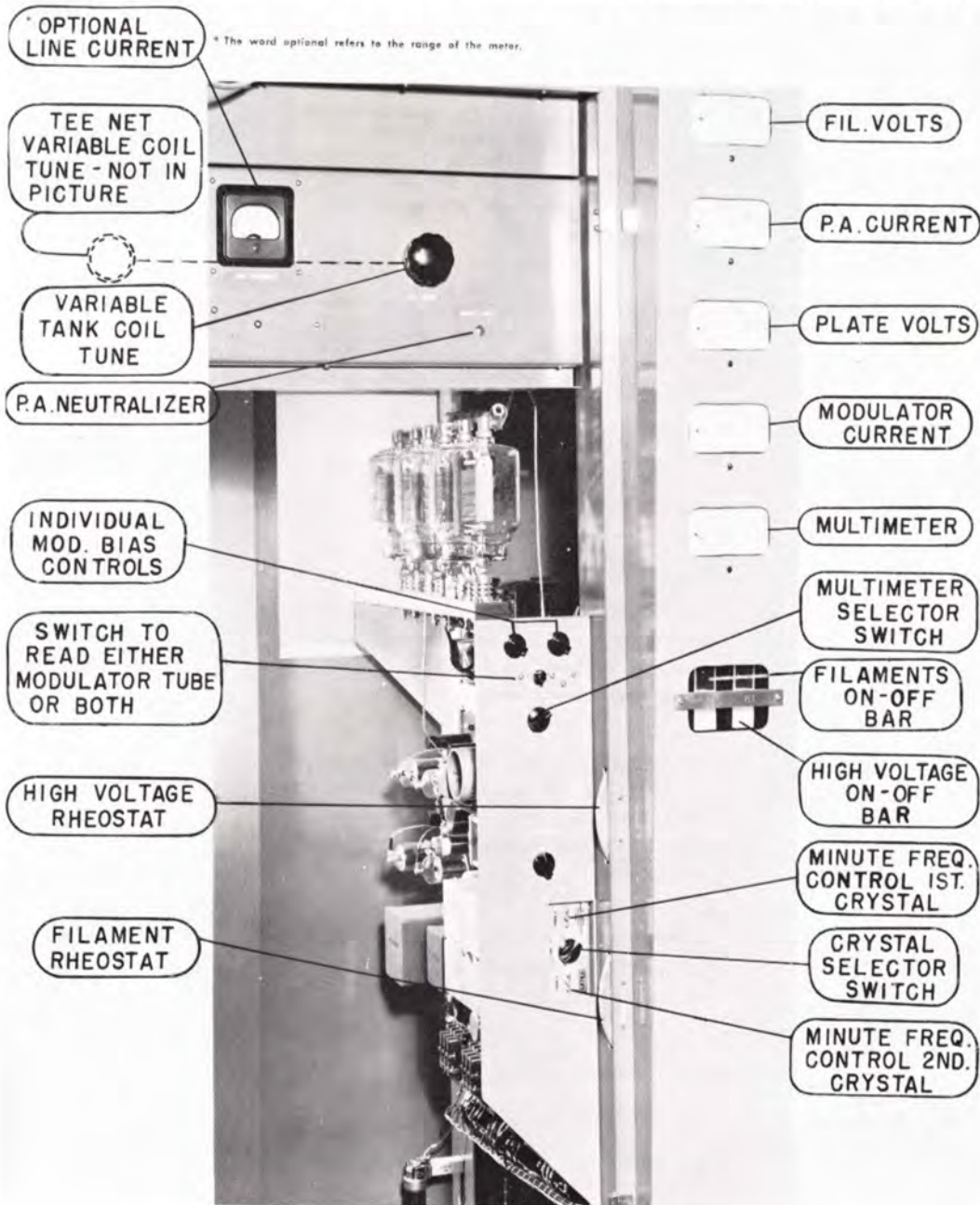

## MODEL BC-1T 1000 WATT AM BROADCAST TRANSMITTER

quiet operating suction fans. One of these is directly over the power tube section. By observing the inner BC-1T construction, the engineer will note all components, large and small, are in the exact circulating air stream. BC-1T cooling has been as much of the engineering consideration as the outstanding electrical design.

**METERING.** The five wide-face 4" meters read every necessary measurable circuit. Individual meters continuously read plate volts, PA plate current, filament volts and modulator current. The fifth meter, a multimeter, is switch selectable to necessary grid and cathode circuits over the entire transmitter. Individual modulator plates may be observed by a key that switches the modulator current meter to either tube. When this key is in the center position, both tubes are metered. A 0-8 line meter is mounted at the top center. The question may be asked as to reaching meters for servicing. The front shield does not hold the meters. This shield is quickly removable and all meters are 100% accessible.

**RF SECTION.** Dual vacuum type crystal units require no temperature oven for pin-point stability. Frequency adjustment and crystal changeover are from the front. There are four RF stages, with all stages self-neutralized except the last. Dual long-life 833A tubes feed 1000 watts into a complete Tee network for exact loading and harmonic attenuation. The final amplifier and Tee network are tuned by variable coils of the large edgewise type, manufactured by Gates. A portion of the audio is applied to the RF driver plate to provide linear RF drive under modulation for improved performance and ease of modulating. The oscillator-IPA unit and RF driver section incorporate printed wiring throughout.

**AUDIO SECTION.** Three stages, all push-pull. The cathode follower driver stage has dual 6BG6G tubes, a tube similar to the 807. The modulation transformer has been designed for extremely low leakage for superb high frequency performance. Typical production BC-1T transmitters continually indicate distortion under 2% at the critical 7000 cycle audio frequency. The modulation



**ABOVE RIGHT:** Open the front door and every tuning control is at finger tip, plus an interlocked grill to observe transmitter components.

**LOWER LEFT:** Side of BC-1T removes to expose the few components not accessible from the front. Reaching every part is an engineering must in Gates transmitters.

**LOWER RIGHT:** Full length rear view of the BC-1T transmitter. The design radiates confidence.



# MODEL BC-1T 1000 WATT AM BROADCAST TRANSMITTER

transformer has two secondary windings, one for high level modulating the Class C amplifier, the other for partially modulating the RF driver. A full sized modulation reactor is also employed. Cathode follower audio drivers, feedback, all push-pull audio and new transformer design produces true high fidelity. Wide frequency response combined with lower than ever distortion provides real listenability.

**POWER SUPPLIES.** One husky, low voltage supply with dual 866A rectifiers delivers well filtered direct current to all stages except the RF power amplifier and modulators. The power tubes are devoted exclusively to the high voltage supply with full wave 8008 rectifiers. A third bias supply for the Class B modulators with individual bias rheostats completes a dependable, easy-working type of power section.

**MONITORS.** This transmitter will operate with all current makes of frequency and modulation monitors. A scramble wound pickup coil inductively couples the modulation monitor. The frequency monitor connects to the 1st IPA in the crystal oscillator section. A modern transmitter accessory cabinet including monitors and limiting amplifier also available.

**CONELRAD.** The BC-1T is designed for instantaneous Conelrad switching by remote control or from front panel controls. The addition of the Conelrad feature is optional.

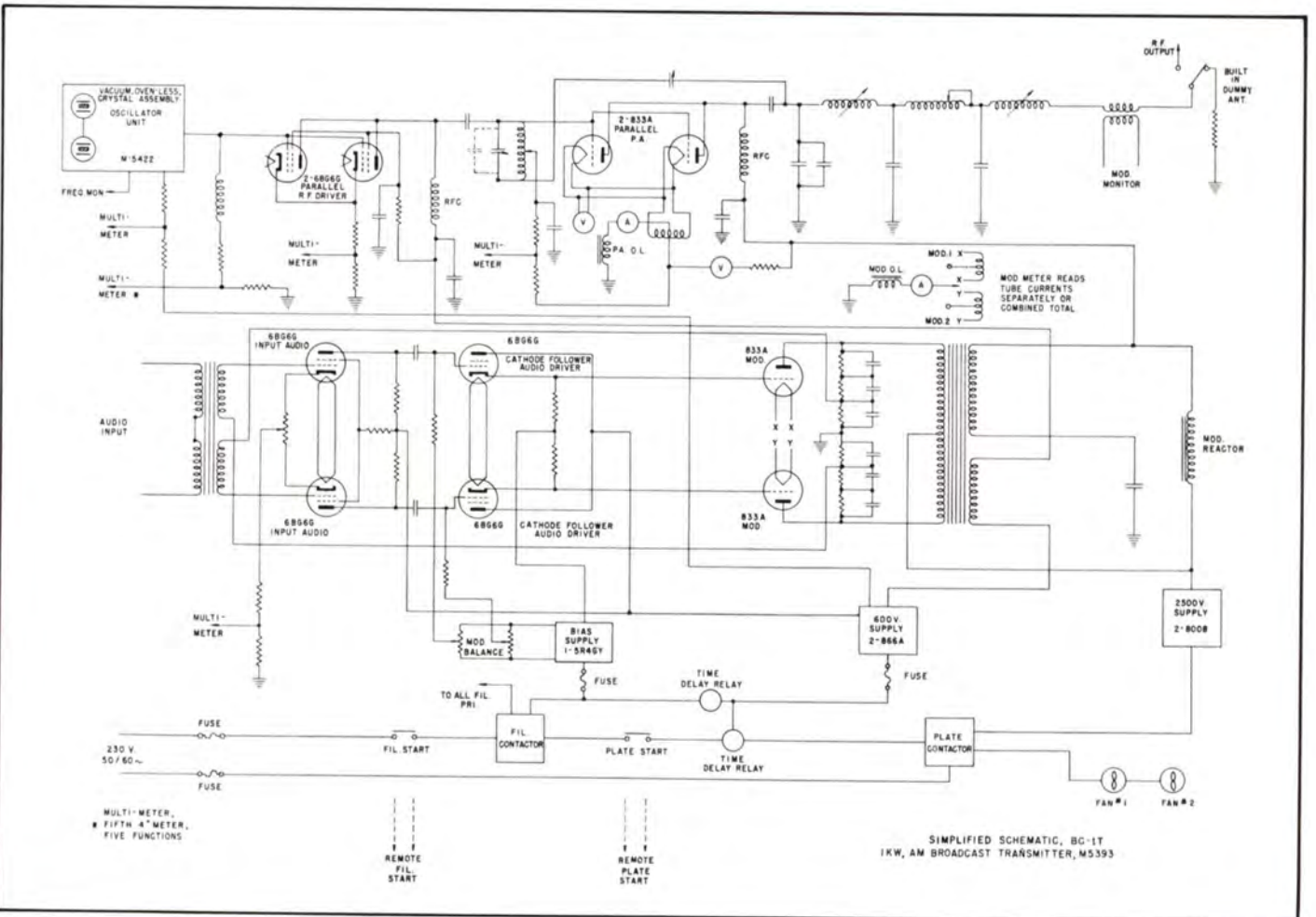
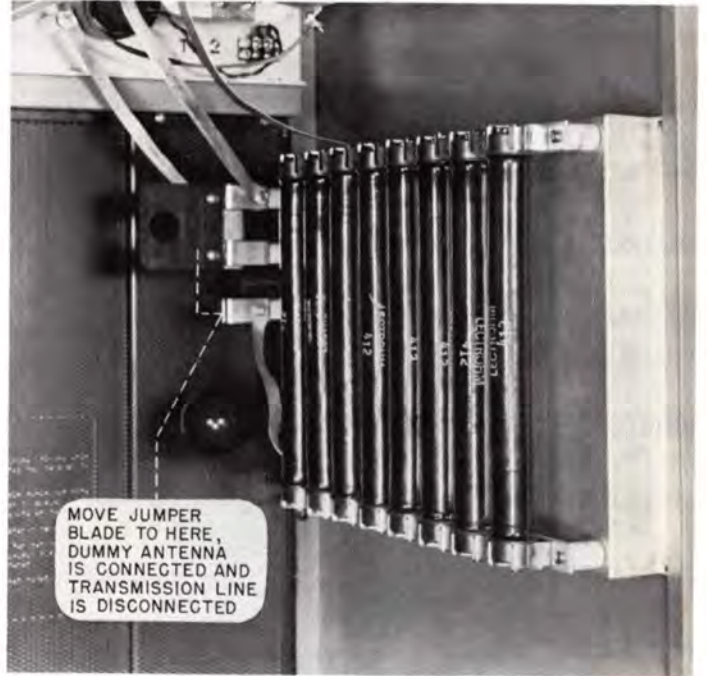



## MODEL BC-1T 1000 WATT AM BROADCAST TRANSMITTER

### SPECIFICATIONS

**POWER OUTPUT:** Rated 1000 watts. Capable 1100 watts.

**RF OUTPUT IMPEDANCE:** 50 ohms, or other as ordered.

**OUTPUT CONNECTOR:** Type ceramic feed-thru bowl, 1/4"-20 hardware.

**RF RANGE:** 540 kc to 1600 kc, as ordered.

**FREQUENCY STABILITY:** ±10 cycles (Typical: ±2 cycles.)

**FREQUENCY MONITOR COUPLING IMPEDANCE:** 50/70 ohms.

**MODULATION MONITOR COUPLING IMPEDANCE:** 50/70 ohms.

**RF HARMONICS:** Suppression of harmonics meets or exceeds FCC requirements.

**POWER REDUCTION:** To 500 W or 250 W.

**AUDIO FREQUENCY RESPONSE:** ±1½ db 30-12,000 cycles. (Typical: ±1½ db 30-16,000 cycles under practical programming conditions.)

**AUDIO HARMONIC DISTORTION:** 3% or less 50-10,000 cycles at 95% modulation. (Typical: 2% or less 50-16,000 cycles under practical programming conditions.)

**AUDIO INPUT LEVEL:** +12 db for 100% modulation.

**AUDIO INPUT IMPEDANCE:** 150/600 ohms.

**PRIMARY VOLTAGE:** 230 volts, 2 wire, 50/60 cycles.

**POWER CONSUMPTION:** 2740 watts at zero modulation, 4000 watts at 100% modulation.

**CARRIER SHIFT:** 3% or less at 100% modulation.

**DUMMY ANTENNA:** 51½ ohms. Capability 1000 watts carrier 100% modulated, inbuilt.

**TUBES:** 12BY7A oscillator, 12BY7A 1st IPA, (2) 6BG6G 2nd IPA, (2) 833A power amplifiers, (2) 6BG6G 1st audio, (2) 6BG6G 2nd audio, (2) 833A modulators, 5R4GY rectifier, (2) 866A LV rectifiers, (2) 8008 HV rectifiers.

**TOTAL NUMBER OF TUBES:** 17

**TOTAL TUBE TYPES:** 6

**SIZE:** 78" high, 36" wide, 32" deep. Front door swing 28".

**WEIGHT:** 800 lbs. net. 1090 lbs. packed.

**CUBAGE:** 110.0

**FINISH:** Finish is in hand rubbed medium gray with trimmings in chrome, brushed aluminum and anodized black.



Open and closed views of the new ovenless, low drift crystal oscillator — first IPA unit.



### ORDERING INFORMATION

AM broadcast transmitter, 1000 watts, with tubes, one crystal, dummy antenna .....	BC-1T
Spare 100% tube complement for above .....	TK-287
FCC tube complement (required FCC spares) .....	TK-288
Spare crystal and holder .....	A-30866

**NOTE:** See page 41 for additional conelrad information.

# 1000/250 WATT AM BROADCAST TRANSMITTER

Model BC-1T

With the Gates BC-1T 1000/250 watt transmitter, you efficiently reduce power to 250 watts nighttime operation by changing the primary voltage of the plate transformer. In this manner, when operating at reduced power of 250 watts, the primary power consumption is at a minimum, and the use of plate voltage dropping resistors, which are power consuming, is eliminated.

This reduced plate voltage at 250 watts power to both the modulator and power amplifier tubes results in hundreds of added tube hours and a great savings in power cost.



The *exclusive* Gates feature of the inbuilt dummy antenna will also be appreciated by the engineer. With two-power operation at 1000 and 250 watts, initial alignment and periodic proof of performance required at two power levels is accomplished with utmost simplicity.

In summary, the BC-1T 1000/250 watt transmitter offers you the convenience of already having a one kilowatt transmitter installed — needing only to throw the switch for a change in power. Power change may also be remote controlled.

For complete technical information on the BC-1T transmitter, see data on preceding pages.

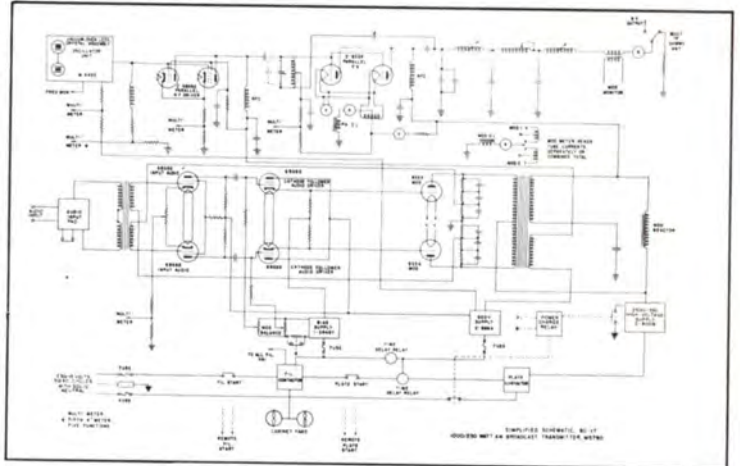

## ORDERING INFORMATION

BC-1T transmitter for 1000/250 watts complete with tubes,  
one crystal, dummy antenna and ready to operate ..... M-5790

NOTE: FCC type approval on 1000/250 transmitter is Model BC-1T.  
Catalog No. M-5790 is for ordering purposes only.

Spare 100% tube complement for above ..... TK-287

FCC tube complement (required FCC spares) ..... TK-288

Conelrad adaptor kit installed in transmitter .....

Spare crystal and holder ..... A-30866

---

**GATES**

# 500 WATT AM BROADCAST TRANSMITTER

Model BC-500T

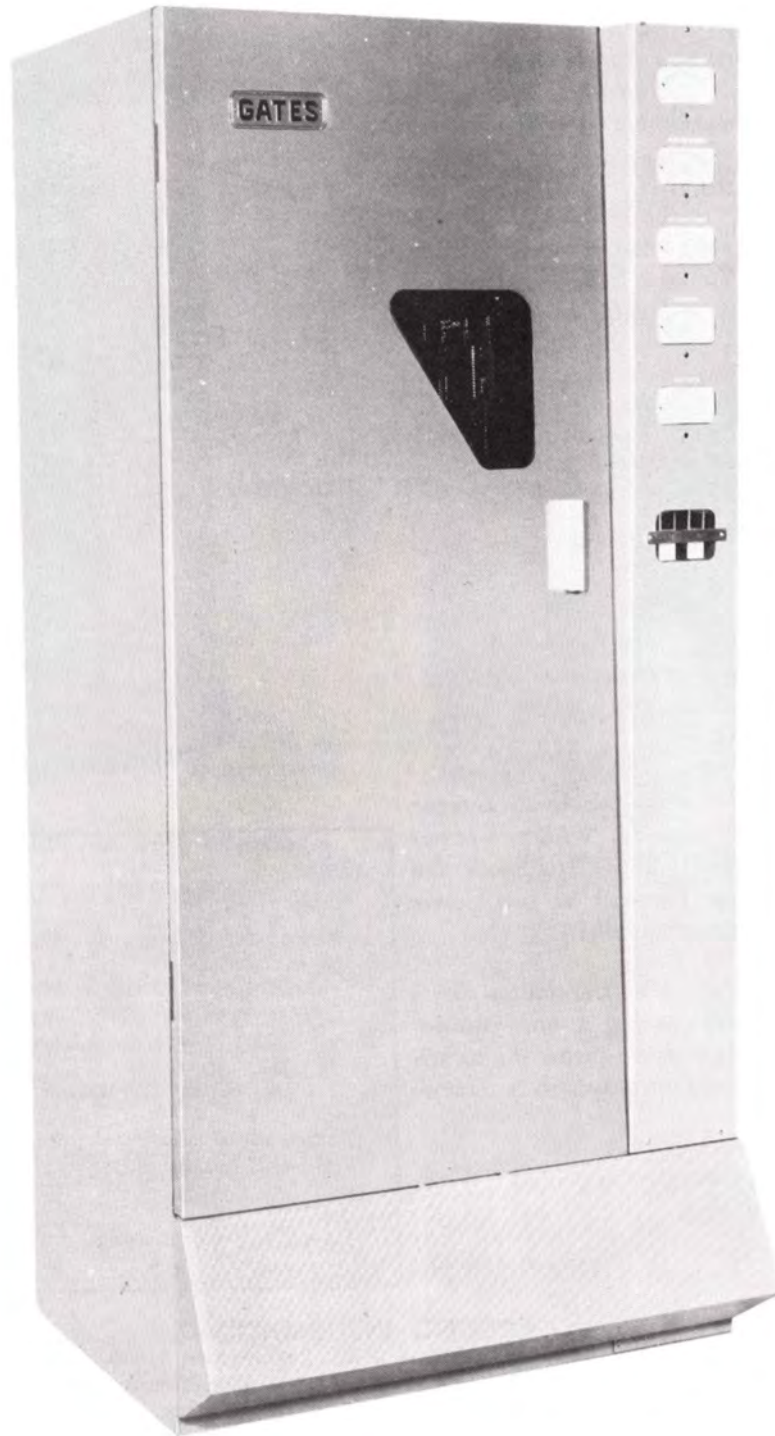

Except where modified for 500 watt service, the BC-500T is essentially the same as the BC-1T, 1000 watt model. Step up to 1000 watts, at any later date, may be done quickly and effectively with the BC-500T.

As the basic description of the BC-500T transmitter is the same as Model BC-1T, the following pages cover information pertinent to the BC-500T and for all other descriptive data the reader is asked to refer to Model BC-1T.

## MODEL BC-500T 500 WATT AM BROADCAST TRANSMITTER

### GENERAL DESCRIPTION

(Model BC-500T)

In standardization of manufacturing processes, the BC-500T transmitter is produced on the same line and with most of the same components as the BC-1T, 1000 watt model. Modification of the BC-1T to become the BC-500T consists of only the necessary basic changes to meet FCC requirements along with proper power, modulation and reactor transformer sizes.

For metering, local-remote control, cooling, general construction, audio section and other data common with BC-500T to the BC-1T, reference to the BC-1T will not only provide the desired information but emphasize the 1000 watt basic design of this modern 500 watt model.



This is BC-500T from the rear. Modern design and husky construction spells confidence for the heaviest broadcasting schedule.

**RADIO FREQUENCY SECTION:** Identical in all respects to Model BC-1T other than a single 833A power amplifier tube is employed.

**AUDIO FREQUENCY SECTION:** Identical in every way to that in the BC-1T other than the modulation transformer and reactor are of 500 watt size.

**POWER SUPPLY SECTION:** The power transformer and filter reactors are of 500 watt size in the high voltage supply. The balance is BC-1T 1000 watt design.

**METERING** for BC-500T is changed to accommodate a 0-5 RF ammeter and a lower range PA plate current meter to meet FCC requirements.

**OFF AIR TESTING** provides the inbuilt dummy antenna for 500 watts carrier 100% modulated. Move the switch bar to "Dummy" and you may test any time. New stations may finish tests prior to even erection of the antenna tower. — For regular maintenance, this feature will save hours of time and add greatly to performance through convenience of routine maintenance. Construction is identical to the BC-1T transmitter.

**PRINTED WIRING** is the same as in the BC-1T.

**LOCAL-REMOTE CONTROL** system in BC-500T is the same relay system as in the BC-1T. No circuit breakers are employed.

**COOLING FEATURES** include full width filtered air intake at the bottom and dual exhaust fans at the top. Same as Model BC-1T.

**PERFORMANCE:** The owner of BC-500T has without question an ultraconservative transmitter when basic 1KW design is followed. Tube life, especially that of the larger tubes, should be extremely gratifying.

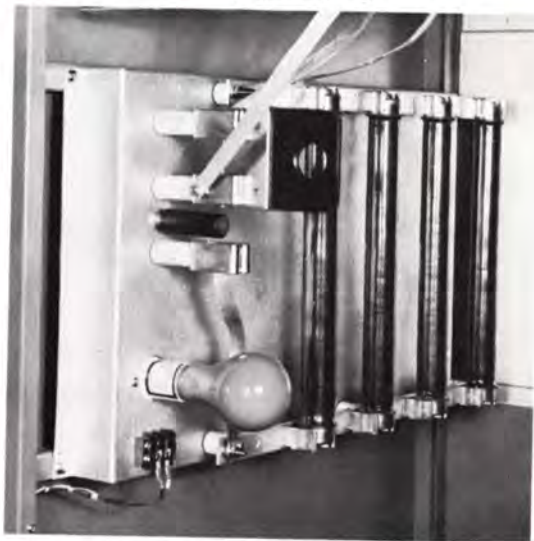

Standard equipment in BC-500T is the inbuilt dummy antenna. Routine maintenance now becomes a pleasure.

## BC-500T SPECIFICATIONS

**POWER OUTPUT:** Rated 500 watts. Capability 550 watts.  
**RF OUTPUT IMPEDANCE:** 50/70 ohms.  
**OUTPUT CONNECTOR:** Type RF feed-thru bushing.  
**RF RANGE:** 540 Kc to 1600 Kc (as ordered).  
**FREQUENCY STABILITY:** ±10 cycles.  
**FREQUENCY MONITOR COUPLING IMPEDANCE:** 50/70 ohms.  
**MODULATION MONITOR COUPLING IMPEDANCE:** 50/70 ohms.  
**RF HARMONICS:** Suppression of harmonics meets or exceeds FCC requirements.  
**POWER REDUCTION:** Reduces to 250 or 100 watts as ordered.  
**AUDIO FREQUENCY RESPONSE:** ±1½ db 30-12,000 cycles. (Typical: ±1½ db 30-16,000 cycles under practical programming conditions.)  
**AUDIO HARMONIC DISTORTION:** 3% or less 50-10,000 cycles at 95% modulation.

**AUDIO INPUT LEVEL:** +9 db ±2 db for 100% modulation at impedance choice.  
**AUDIO INPUT IMPEDANCE:** 150, 250, or 600 ohms.  
**PRIMARY VOLTAGE:** 230 volts, 3 wire, 50/60 cycles single phase.  
**POWER CONSUMPTION:** 2400 watts at zero modulation, 3000 watts at average modulation, 3150 watts at 100% modulation.  
**CARRIER SHIFT:** 3% or less at 100% modulation.  
**TUBES:** 12BY7A oscillator, 12BY7A 1st IPA, (2) 6BG6G 2nd IPA, (1) 833A power amplifier, (2) 6BG6G 1st audio, (2) 6BG6G 2nd audio, (2) 833A modulators, 5R4GY rectifier, (2) 866A LV rectifiers, (2) 8008 HV rectifiers.  
**TOTAL NUMBER OF TUBES:** 16  
**TOTAL TUBE TYPES:** 6  
**SIZE:** 78" high, 36" wide, 32" deep. Front door swing 28".  
**WEIGHT:** Domestic — 700 lbs. net, 990 lbs. packed.  
**CUBAGE:** Domestic — 61.  
**FINISH:** Medium hand rubbed gloss gray, two tone.

### ORDERING INFORMATION

Model BC-500T AM broadcast, 500 watts, with tubes, one crystal .....	<b>BC-500T</b>
Spare 100% tube complement for above .....	<b>TK-300</b>
FCC tube complement (required FCC spares) .....	<b>TK-307</b>

**NOTE:** State carrier frequency when ordering. Other primary voltages available on special order and without delay.

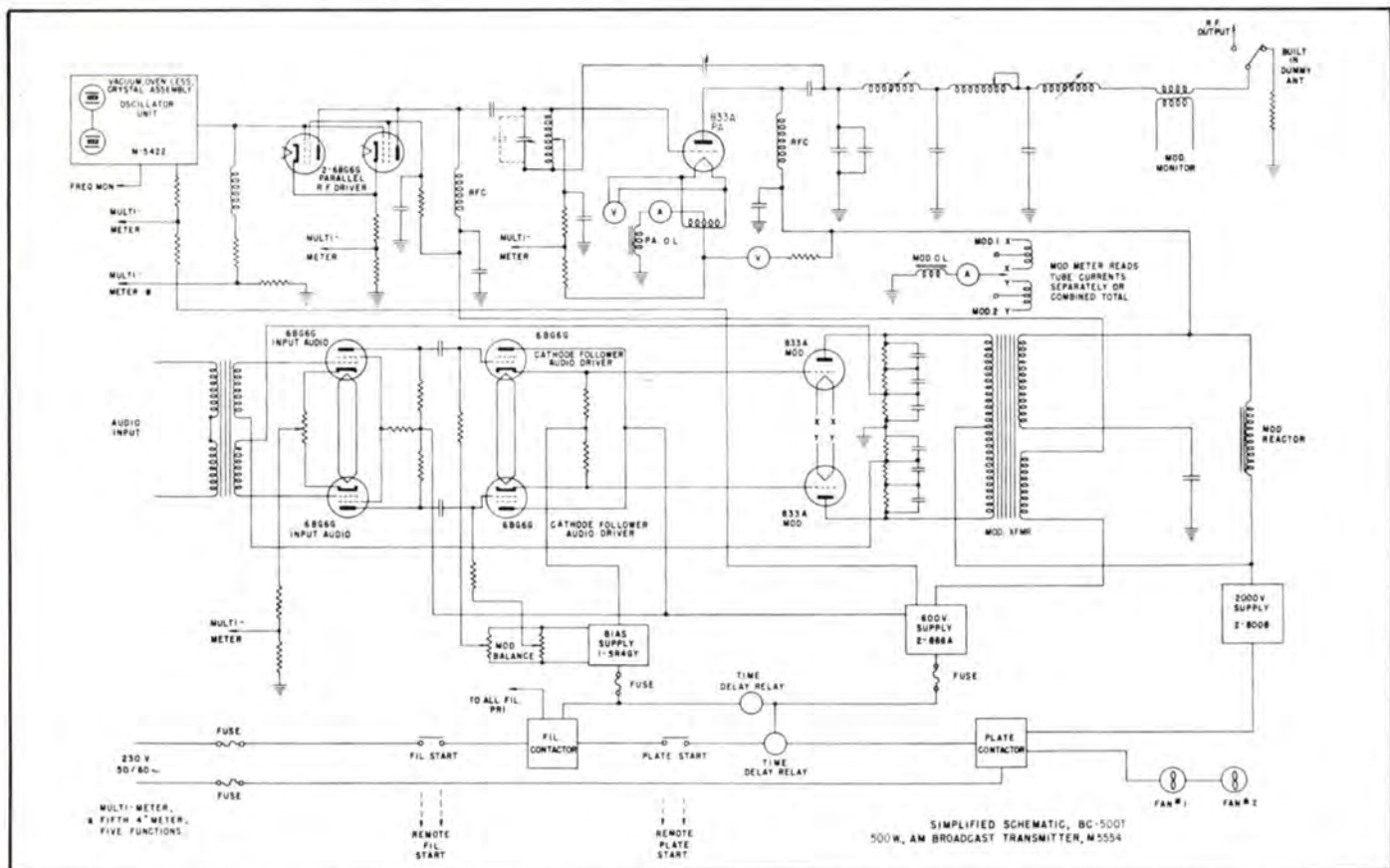

# 250 WATT AM BROADCAST TRANSMITTER

Model BC-250T  
(with power step up design)

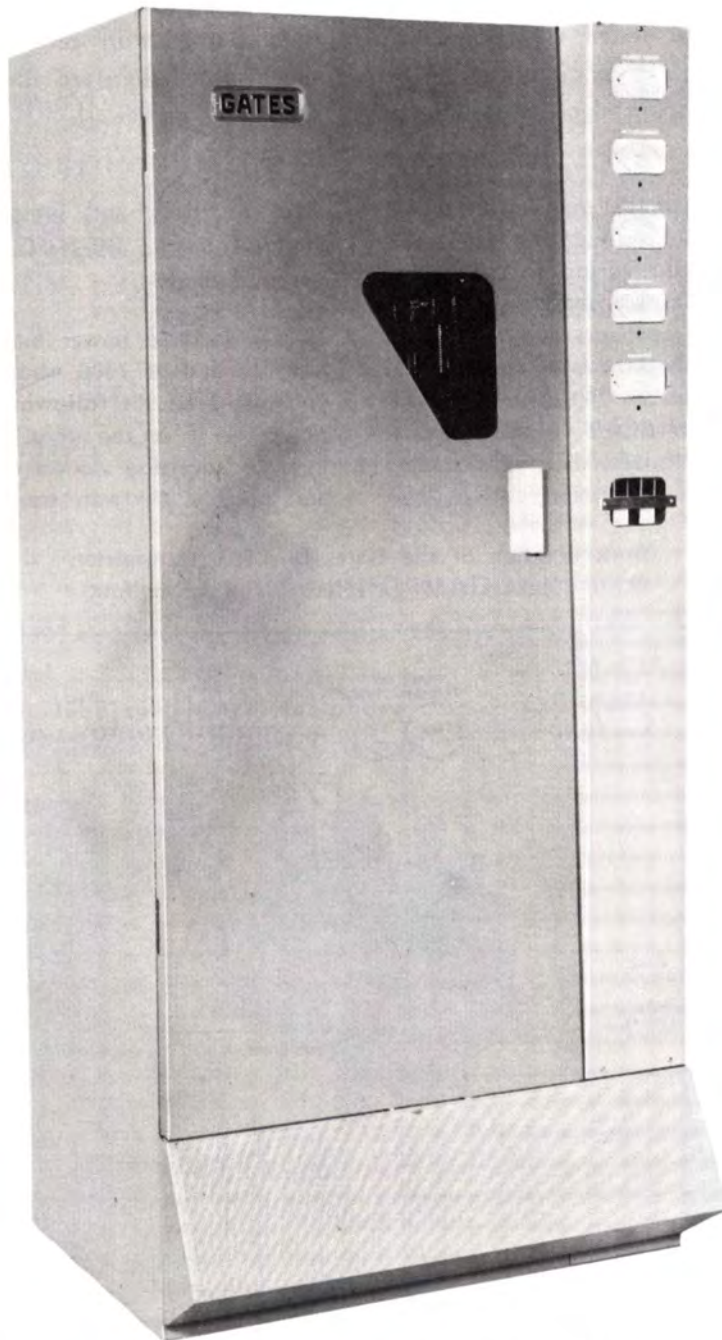

Model BC-250T is a basic 1000 watt design modified and fully FCC approved for 250 watt operation. Broadcasters now operating on 250 watts with an eye to future higher power, may immediately own an ultra conservative 250 watt equipment and step up later to 500 or 1000 watts by purchasing a "power increase kit". — Change to higher power can be made in 2 hours' time, resulting in a fully FCC approved higher powered model.

## MODEL BC-250T 250 WATT AM BROADCAST TRANSMITTER

This model is offered to the broadcast industry to fill future expansions as well as the most conservative 250 watt equipment ever offered. — Actually the BC-250T transmitter is a model BC-1T, 1000 watt design, fully described in this catalog, with certain minor changes to meet 250 watt FCC and engineering requirements. So similar are the designs, the reader may obtain basic data by reading BC-1T descriptive matter.



Four 810 tubes in the 250 watt model replace the 833A tubes in higher powered models. Even here the tube socket chassis are interchangeable and wiring to either the 810 or 833A tubes is the same. Power, modulation, filter and reactor transformers, filter capacitors and mica tank capacitors are specifically for the 250 watt model. All other components are the same in the 250 watt BC-250T, 500 watt BC-500T or 1000 watt BC-1T. — Such items as tank coils, Tee-network coils, intermediate power supplies, metering, protective relays, insulation, cabinet de-

sign, oscillator and intermediate power amplifier are identical in the BC-250T transmitter to that of higher powered models.

If you increase power later, order the "power increase kit" for 500 or 1000 watts as listed in this catalog and you may start the following day's broadcasting at higher power. — If, on the other hand, you never increase power, your broadcasting station will own the most conservative and reliable 250 watt equipment ever built.

Block diagram of the Gates BC-250T transmitter.  
Basic 1000 watt design is employed throughout.

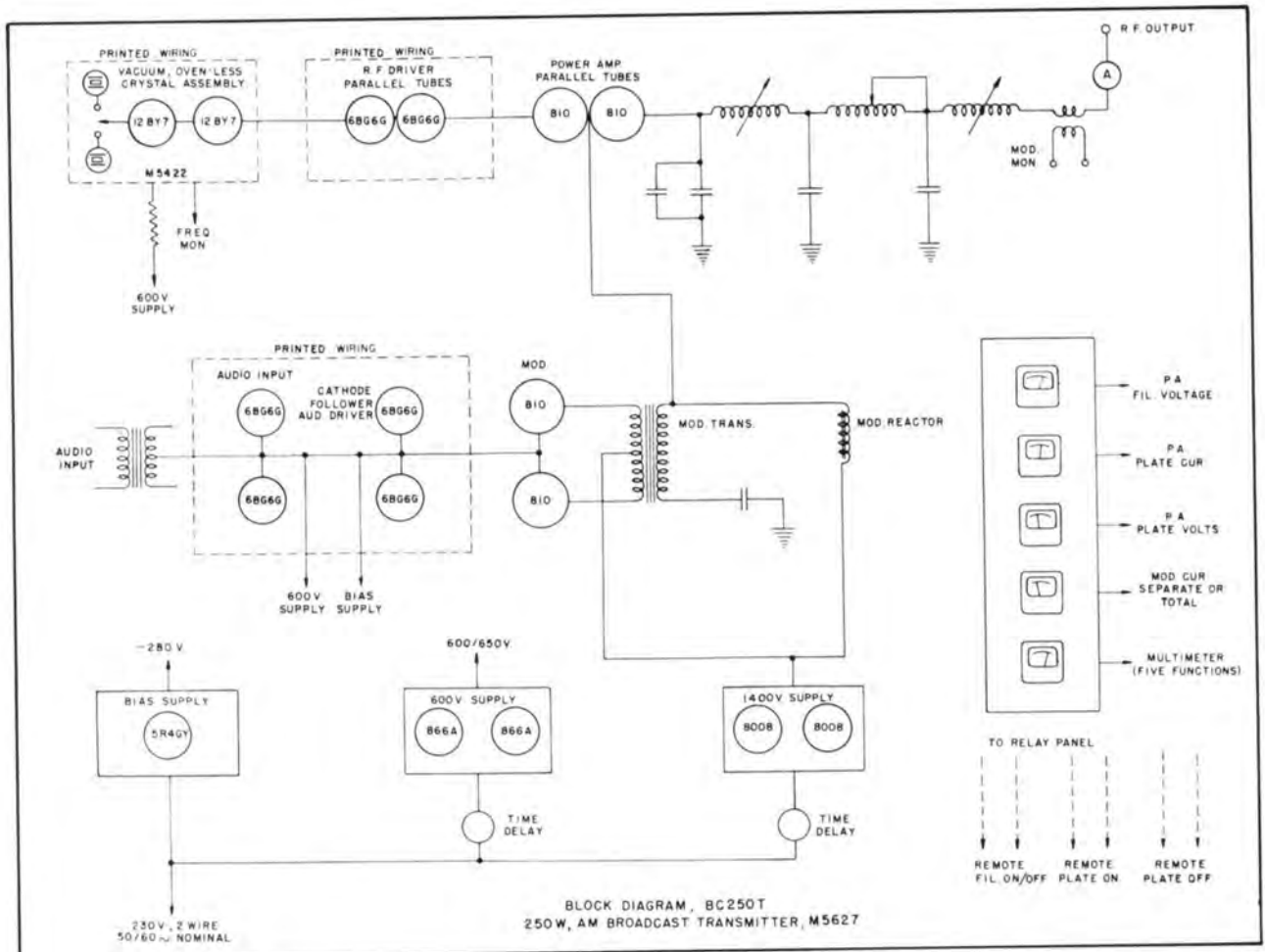

**BC-250T SPECIFICATIONS**

**POWER OUTPUT:** Rated 250 watts, Capability 300 watts.

**RF OUTPUT IMPEDANCE:** 50/70 ohms.

**OUTPUT CONNECTOR:** Type RF feed-thru bushing.

**RF RANGE:** 540-1600 Kc.

**FREQUENCY STABILITY:**  $\pm 10$  cycles.

**FREQUENCY MONITOR COUPLING IMPEDANCE:** 50/70 ohms.

**MODULATION MONITOR COUPLING IMPEDANCE:** 50/70 ohms.

**RF HARMONICS:** Suppression of harmonics meets or exceeds FCC requirements.

**AUDIO FREQUENCY RESPONSE:**  $\pm 1\frac{1}{2}$  db, 30-12,000 cycles. (Typical:  $\pm 1\frac{1}{2}$  db 30-16,000 cycles under practical programming conditions.)

**AUDIO HARMONIC DISTORTION:** 3% or less 50-10,000 cycles (at 95% modulation).

**AUDIO INPUT LEVEL:** 7 db  $\pm 2$  db for 100% modulation.

**AUDIO INPUT IMPEDANCE:** 150 or 600 ohms.

**PRIMARY VOLTAGE:** 230 volts, 3 wire, 50/60 cycles single phase.

**POWER CONSUMPTION:** 1100 watts at zero modulation, 1450 watts at average modulation, 1500 watts at 100% modulation.

**CARRIER SHIFT:** 3% or less at 100% modulation.

**TUBES:** 12BY7A oscillator, 12BY7A first IPA, (2) 6BG6G second IPA, (2) 810 power amplifier, (2) 6BG6 input audio, (2) 6BG6G cathode follower drivers, (2) 810 modulators, (2) 866A intermediate power rectifiers, (2) 8008 main power rectifiers, (1) 5R4GY bias rectifier.

**TOTAL NUMBER OF TUBES:** 17

**TOTAL TUBE TYPES:** 6

**SIZE:** 78" high, 36" wide, 32" deep.

**WEIGHT:** — 750 lbs. net, 1070 lbs. packed.

**CUBAGE:** — 71.

**FINISH:** Medium hand rubbed gloss gray in two tones.

**ORDERING INFORMATION**

Model BC-250T AM broadcast transmitter, 250 watts, with tubes, one crystal .....	BC-250T
Spare 100% tube complement for above .....	TK-306
FCC tube complement (required FCC spares) .....	TK-307

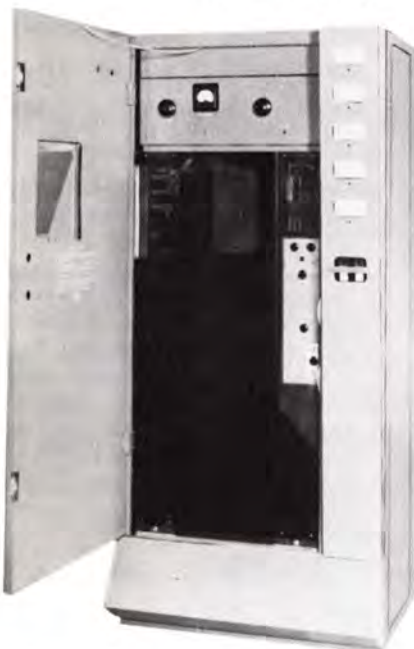

Open BC-250T front door to reach all tuning controls. Slip off the snap-on interlocked perforated grill to reach all parts from the front. BC-250T is the only transmitter manufactured today with complete parts visibility during operation.



⏏  
Dual vacuum mounted crystals are designed into a new oscillator with the emphasis on stability and dependability.  
⏏



The back is removable but you will never need to with BC-250T as all servicing is from the front, or right side.



# PACKAGED RADIO BROADCASTING EQUIPMENT



These three models of complete radio stations are ready to attach to studio and transmission lines. The 250 watt BC-250T, the 500 watt BC-500T or the 1000 watt BC-1T transmitters are joined with all necessary FCC approved monitors, audio equipment and with optional remote control apparatus. This equipment is mounted, wired and tested. Along with assured system performance is offered a most attractive and eye-catching broadcasting equipment installation.

## PACKAGED RADIO BROADCASTING EQUIPMENT

(for 1000, 500, 250 watts ready to install)

For many years, the Gates complete packaged radio station has been very popular. Provided is everything necessary to attach studio equipment and transmission line to the antenna. Transmitter, monitors, audio equipment and remote control equipment, where used, is all packaged and ready to install. — The result is speedier installation through the purchase of a complete system. As wiring is complete, the installation engineer need not concern himself with the details ordinarily associated with piece by piece procurement.

Four input lines are switch selectable. A switch is also incorporated to bypass the limiting amplifier. In this manner an emergency tube change in the limiter does not necessitate leaving the air.

All equipment components of the accessory cabinet are fully described on a near adjacent page (see Index "Accessory Cabinet"). Remote control equipment referred to herein is also covered in detail elsewhere in this catalog.

## SPECIFICATIONS

TRANSMITTER: For 1000 watts, Model BC-1T.  
For 500 watts, Model BC-500T.  
For 250 watts, Model BC-250T.

MODULATION MONITOR: Gates M-5693 (FCC approved).

FREQUENCY MONITOR: Gates M-4990 (FCC approved).

LIMITING AMPLIFIER: Gates SA-39B.

SWITCHING PANEL: 4 switch selectable 600 ohm inputs to limiter. One input selector switch to limiter or transmitter direct.

SIZE OVERALL(including transmitter): 78" high, 59 1/2" wide, 32" deep.

REMOTE CONTROL (optional): Gates Model RDC-10 with transmitter unit mounted and wired in cabinet and studio unit ready to install in studios, includes plate current, plate voltage and tower light extension kits, also motor tuned power adjusting rheostat. Also includes modulation monitor and frequency monitor extension meters for studio installation, (see Index "Remote Control" for full detail).

## ORDERING INFORMATION

Complete 1000 watt radio station with one set of tubes, crystal, less remote control .....	GY-1000B
Complete 1000 watt radio station with one set of tubes, crystal and with remote control .....	GY-1000BRDC
Complete 500 watt radio station with one set of tubes, crystal, less remote control .....	GY-500B
Complete 500 watt radio station with one set of tubes, crystal and with remote control .....	GY-500BRDC
Complete 250 watt radio station with one set of tubes, crystal, less remote control .....	GY-250B
Complete 250 watt radio station with one set of tubes, crystal and with remote control .....	GY-250BRDC

# CONELRAD



LEFT: Gates "T" series transmitters, 250 watts through 1000 watts.

RIGHT: Gates "P" series, 5000 and 10,000 watts.

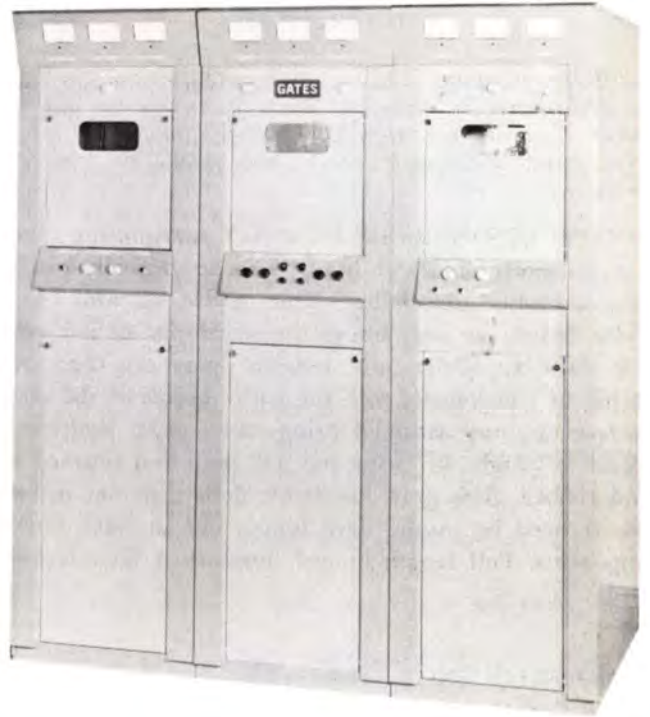

With the increased importance of the CONELRAD program in the national defense picture, and with the expected intensification of CONELRAD participation, it becomes extremely important to consider just how well your transmitting equipment will adapt to CONELRAD, now and in the future.

CONELRAD operation has been carefully considered in the design of all current Gates transmitters through ten kilowatts in the AM broadcast line. Each Gates broadcast transmitter, 250 watts through 5000 watts, is available with factory installed CONELRAD switching on specific order and at modest cost. The Gates BC-5P-2 5000 watt AM transmitter may also be supplied with an extra 5 kilowatt RF cubicle for CONELRAD operation, utilizing the power and audio cubicles, which are a part of the regular transmitter. This feature offers the advantage of having a complete extra RF 5000 watt cubicle available in an emergency. The 5 kilowatt CONELRAD cubicle can also be used in connection with the Gates BC-10P 10,000 watt AM transmitter, providing full 5 kilowatt output on either CONELRAD frequency.

The Gates "T" series transmitters, 250 watts through 1 kilowatt, have been designed for instantaneous CONELRAD switching by remote control or from front panel controls.

Whether it is internal switching or an extra cubicle, the change to CONELRAD is instantaneous and is as simple as pushing a button. Kits are available to add CONELRAD to any current model Gates AM broadcast transmitter through 10 kilowatts now in the field. Your inquiry is invited.

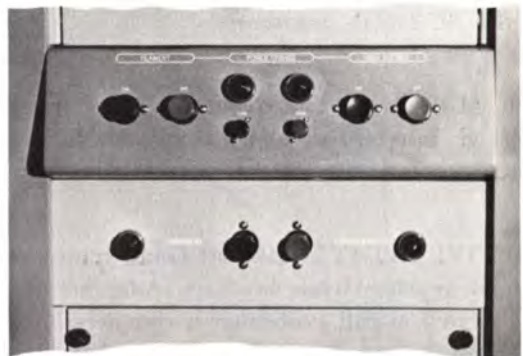

Switching to and from CONELRAD frequencies on the BC-5P-2 5000 watt transmitter is accomplished by merely pushing a button for each function.

# 250 WATT BROADCAST TRANSMITTER

## Model BC-250GY

The Gates BC-250GY has a world-wide reputation for long trouble-free service, and is the most used 250 watt broadcast transmitter in America. Walk in to service, big component design and extra generous facilities. The Gates BC-250GY transmitter is rightfully called, "The work horse of the broadcast industry." If the frequency allocation will never permit increase in power, this model BC-250GY is the proper selection.

**CONSTRUCTION.** In the BC-250GY transmitting plant is an assemblage of large heavy parts strategically placed for instantaneous accessibility. This, added to walk-in-to-service design, not only brings the admiration of the technical staff but spells cool, reliable operation. Generous spacing of components with the entire center of the cabinet free air, just naturally brings this result. Built in a cabinet 78" high, 40" wide and 33" deep and finished in hand rubbed gloss gray. Oscillator deck slips out in seconds if need be. Audio deck hinges out to reach under components. Full length hinged interlocked door is provided.

**RADIO FREQUENCY.** Three stages, provision for 2 crystals in temperature controlled ovens, 813 RF driver provides abundance of drive and long tube life, 2 type 810 single ended power amplifiers feed an output coupling network that will match specified impedances from 30 to 300 ohms.

**AUDIO FREQUENCY.** Two audio stages consist of push-pull 6L6's driving two 810 tubes operating as Class B high level modulators. Conservatively rated 810's in the modulator insure reliable operation and added tube life.

**METERING.** Eight meters, more than in any other 250 watt broadcast transmitter. Includes: oscillator plate, RF driver plate, PA grid, PA plate, plate volts, filament volts, modulator plate and RF output. There is no multi-metering in the BC-250GY transmitter.

**POWER SUPPLIES.** Two power supplies develop the high voltage, intermediate and bias voltages for the entire transmitter.

**PROTECTIVE RELAYS.** Like all Gates transmitters, relays largely replace circuit breakers. Adaption to remote control, as well as full protection is complete in this type design. Two overload relays for power amplifier and modulator are incorporated plus plate contactor relay and vacuum time delay relay. Ease of attaching remote control is self-evident.



**POWER RESISTORS.** All heavy sized power resistors are of the ferrule or plug-in type. This not only assures easy replacement but is indispensable for cleaning and assures no breakage during shipment.



# 10,000 WATT FM BROADCAST TRANSMITTER

Model FM-10A

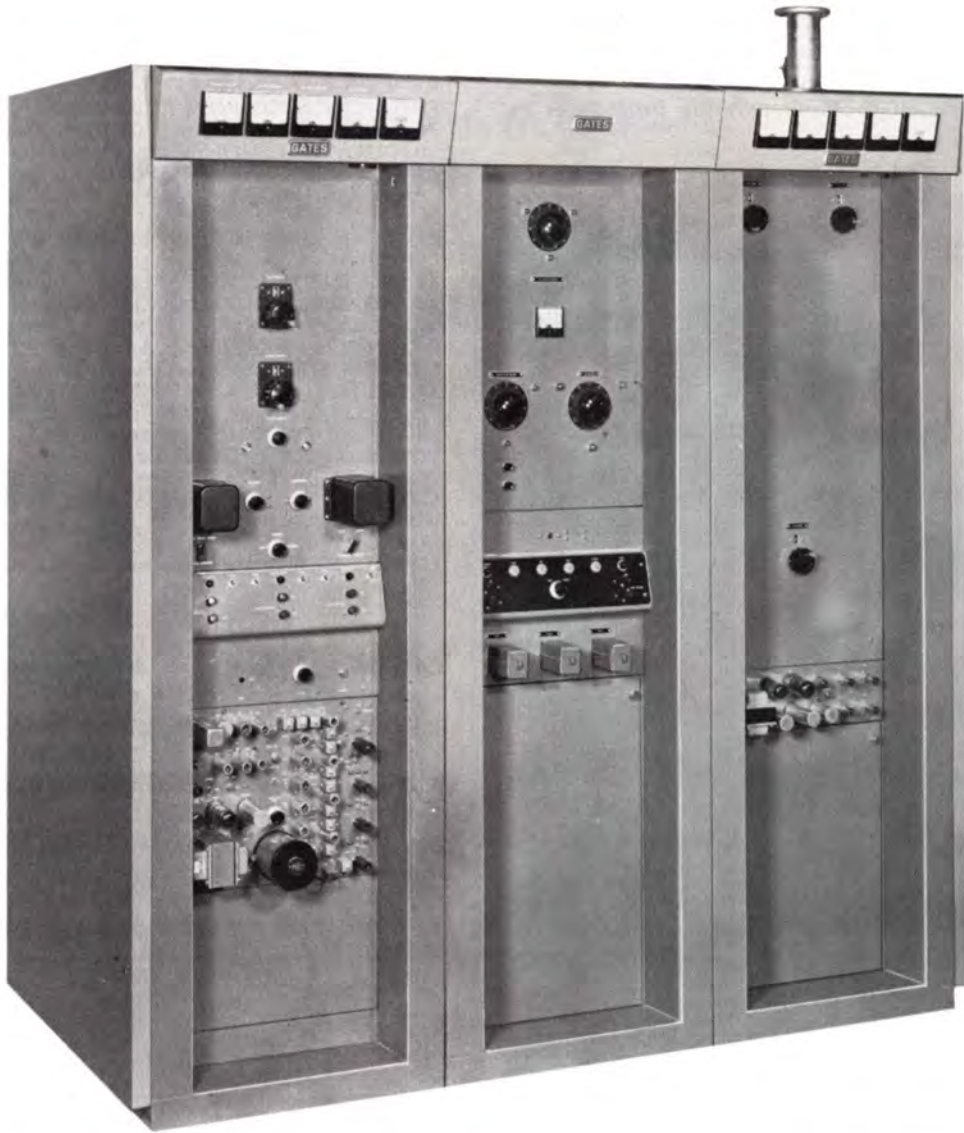

The FM-10A 10,000 watt FM transmitter, representing a cumulation of more than 15 years of research and development experience in FM transmitters, offers a new design for long tube life, much lower distortion at wider response, and includes the all new Gates exciter with high stability.

An exclusive feature of this new transmitter is *Varia-line tuning*. Varia-line tuning is a new method of tuning a single ended VHF amplifier. A portion of a parallel plate transmission line is made variable to capacity tune the line to operating frequency. The tuning is directly from the front panel. With this exclusive new develop-

ment, neither mica nor vacuum capacitors are needed in the tank circuit, and by providing optimum Q, the general efficiency of the tank circuit is greatly increased.

The left cubicle of the FM-10A transmitter is a complete 1000 watt FM transmitter, and includes two intermediate power amplifiers, control panel, exciter and the 3500 volt power supply. The center cabinet houses the control portion and the 6000 volt supply for the 10 kw amplifier, and also the control panel for the 10 Kw amplifier. The right hand cubicle houses the 10 kw amplifier, bias supply, blower and other complimentary materials.

## MODEL FM-10A 10 KW FM TRANSMITTER



The new Gates exciter with high stability employs a phase shift modulator with pulse timing techniques, and may be adapted to single or dual channel multiplexing on a plug-in basis, with blank panel space provided for this future addition. From exciter output to transmission line at 10,000 watts, there are only three radio frequency stages.

In the center cubicle is located the complete 6000 volt power supply, relay equipment for starting and stopping the amplifier, overloads and safety protection for the amplifier — all 100% independent of the 1 KW driver transmitter. One type 6166 tube is used in a single ended amplifier to produce a liberal 10 KW of power. This stage operates the tube well under its maximum ratings, assuring long tube life. The main power supply develops 6000 volts from a three phase full wave rectifier supply. An important feature of this new transmitter is the lack of frequency multiplication after the exciter. This aids in eliminating spurious frequencies and adds tube life, as

power type tubes doubling or tripling frequency are seldom operated at their most stable life lengthening conditions.

The output of the transmitter is standard 3 1/8" coax transmission line. Directly preceding the 3 1/8" coax elbow is a micro-match unit, which is used to meter the RF output and indicate the standing wave ratio on the transmission line. A notch or "T" type filter is supplied after the micro-match as standard equipment. This is a quarter-wave stub to substantially eliminate the second harmonic that may fall in the TV broadcast band. After this notch or "T" type filter is a low pass filter to eliminate third and higher order harmonics. Both low pass filter and "T" notch filter are supplied as part of the transmitter, tuned to the customer's frequency.

The 10 KW power amplifier and the intermediate power amplifier are totally enclosed both electrically and mechanically. Both tubes and components are in a non-ferrous

**MODEL FM-10A 10 KW FM TRANSMITTER**



type housing. Air from individual blowers cool both tubes and parts within these housings.

Mechanically, the FM-10A transmitter has been designed to be easily maintained. Ready accessibility to all parts is accomplished by lift-off type doors. Accessibility to the blower and main power transformer is provided by other lift-off doors in front of center and extreme right end cabinets.

With the addition of this new 10 kilowatt transmitter, Gates now has available six distinctive FM transmitters—10 and 50 watts, 250 watts, 1,000 watts, 5,000 watts and 10,000 watts. These are all top-quality precision transmitters, built for greater reliability and higher than ever performance standards.

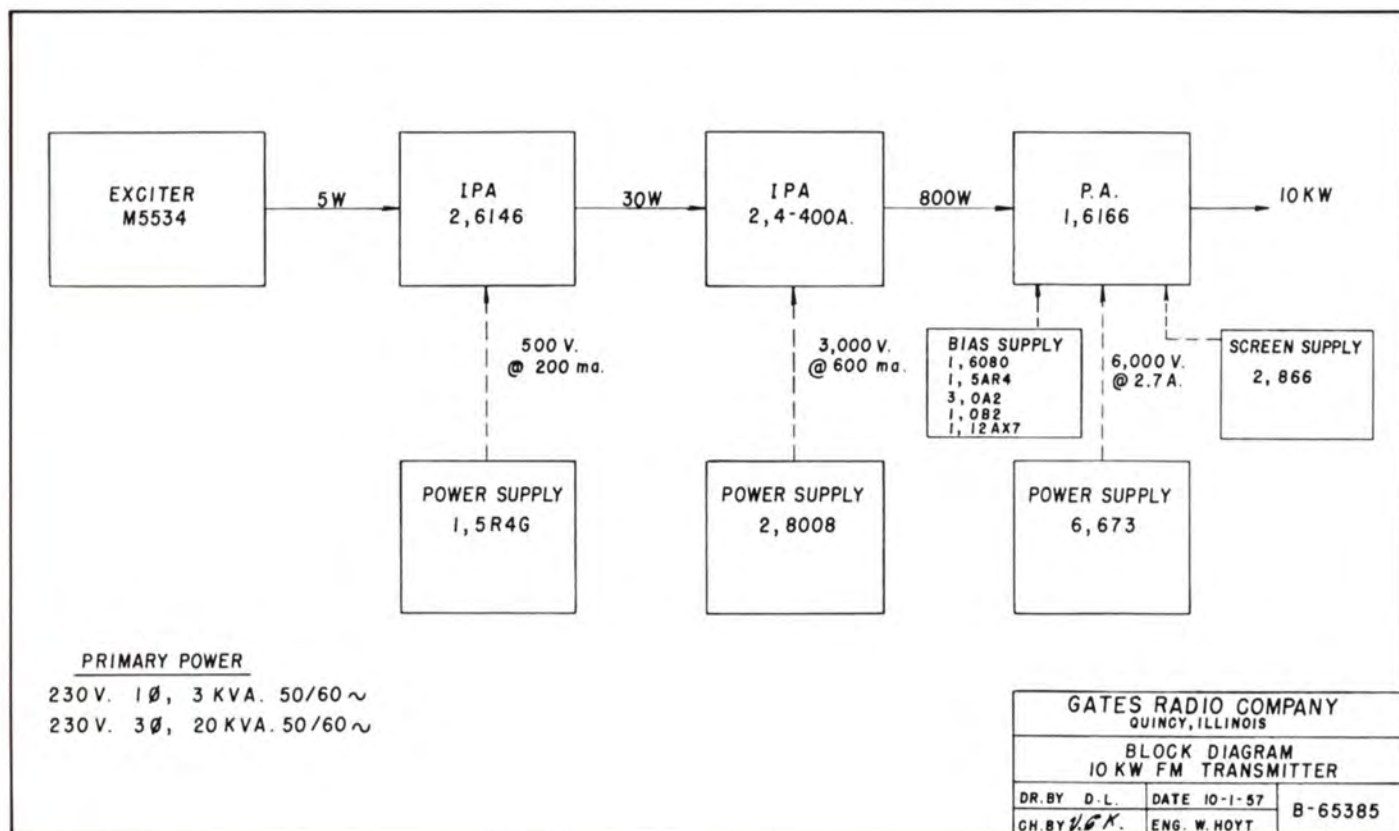

**MODEL FM-10A 10 KW FM TRANSMITTER**

**POWER OUTPUT:** 10,000 watts.  
**FREQUENCY RANGE:** 88 to 108 megacycles.  
**FREQUENCY STABILITY:**  $\pm .001\%$ .  
**R.F. OUTPUT IMPEDANCE:** 50.0 ohms.  
**TYPE OF OSCILLATOR:** Direct Crystal Controlled.  
**R.F. OUTPUT CONNECTOR:**  $3\frac{1}{8}$ " coax flange.  
**MODULATION CAPABILITY:**  $\pm 100$  KC (+75 KC is considered 100% modulation).  
**R.F. HARMONCS:** Suppression of harmonics meets the new FCC requirements. Second harmonic down at least -82 db.  
**FREQUENCY RESPONSE:** Within 1 db of standard 75 micro-seconds pre-emphasis curve, or flat  $\pm 1$  db, 50 to 15,000 cycles whichever is desired. (Specify).  
**DISTORTION AT 100% MODULATION:**  
 1% or less, 50 to 100 cycles.  
 .5% or less, 100 to 10,000 cycles  
 1% or less, 10,000 to 15,000 cycles  
**AUDIO INPUT IMPEDANCE:** 600 ohms.  
**AUDIO INPUT LEVEL:** For 100% modulation — +10 dbm,  $\pm 2$ db.  
**NOISE:** 65 db below 100% modulation (FM)  
 50 db below equivalent 100% (AM) modulation.  
**POWER CONSUMPTION:** 19.8 KW.  
**POWER INPUT:** 10 KW amplifier, 230 volts, 50/60 cycle, 3 phase 30 KVA demand.  
 1 KW driver: 230 volts, 50/60 cycle, 1 phase grounded neutral, 5KVA demand.

**SPECIFICATIONS**



**TUBE COMPLEMENT:**

7 - 6AU6	1 - 6360
4 - 12AX7	1 - 6AQ5
3 - 6J6	2 - 6080
5 - OA2	2 - GZ34/5AR4
1 - OB2	1 - 5R4GYA
2 - 6146	6 - 673
2 - 4-400A	1 - 6166
2 - 8008	2 - 866

**TOTAL NUMBER OF TUBES:** 42  
**TOTAL TUBE TYPES:** 16  
**SIZE:** Width—72", height—78", depth—36 $\frac{1}{2}$ ".  
**WEIGHT:** Packed 2825 lbs. approx.  
 Net 1985 lbs. approx.  
**CUBAGE:** 290 cu. ft. packed.

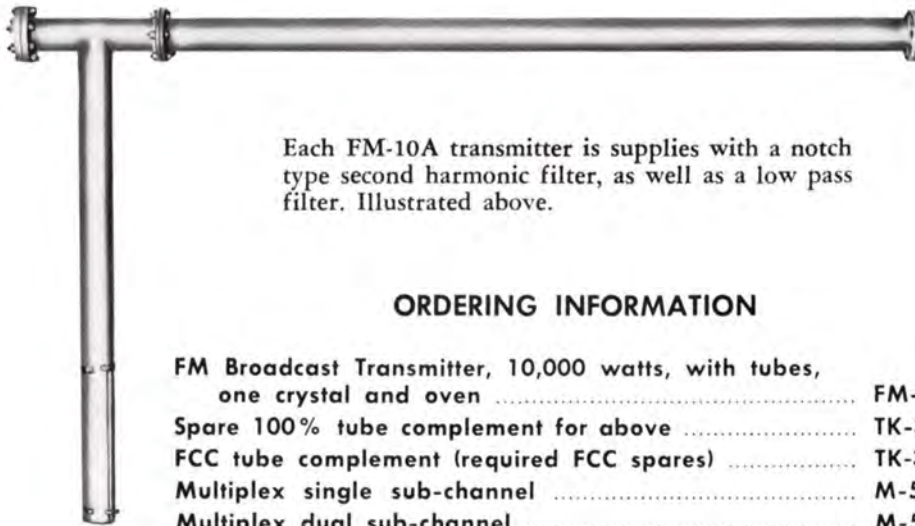

Each FM-10A transmitter is supplied with a notch type second harmonic filter, as well as a low pass filter. Illustrated above.

**ORDERING INFORMATION**

- FM Broadcast Transmitter, 10,000 watts, with tubes, one crystal and oven ..... **FM-10A**
- Spare 100% tube complement for above ..... **TK-349**
- FCC tube complement (required FCC spares) ..... **TK-350**
- Multiplex single sub-channel ..... **M-5633A**
- Multiplex dual sub-channel ..... **M-5633**

*Note: Please specify carrier frequency when ordering.*



# 5000 WATT FM TRANSMITTER

Model FM-5B

(MULTIPLEXING OPTIONAL)

Here is a 5KW FM transmitter with the emphasis on stability, ease of maintenance and long tube life. — A new exciter design eliminates the delicacy often associated with earlier FM generators. The driver is a complete 250 watt FM transmitter coupled low impedance (50 ohms) to the 5000 watt power amplifier. Driver and power amplifier are entirely independent, even to control circuits and power supplies. RF harmonic filter is standard equipment while multiplex for single or dual channel operation may be installed at any time. The Gates FM-5B, 5000 watt FM transmitter is new from crystal to output, yet already time proven in many of America's leading broadcasting stations.

From the output of the exciter unit to transmitter output there are only two radio frequency stages, the 4X250B driver amplifier and the push-pull 6076 power tubes for 5000 watts. Combined with an abundance of excess air and the very conservative use of the 6076 tubes, much longer tube life should be expected. — Ten watts are developed at the exciter output. A phase shift oscillator with pulse timing techniques, permits the use of standard off-the-shelf, low cost tubes and without special selection. Continued low distortion readings after tube changes may be expected without retuning or adjustment.

Provision for single or dual channel multiplex eliminates adaptor arrangements when multiplex is added. The new Gates multiplex system is widely acclaimed for its new approach in simplicity and effective operation.

**GENERAL DESIGN:** The left cubicle is the driver section, which is the complete 250 watt FM transmitter. In this cubicle are located the exciter, provision for multiplex, 250 watt amplifier, control circuits and power supplies. The 250 watt metering complement has included, a VSWR meter. This aids greatly in the correct adjustment for driving the 5KW amplifier as related to both power transformer and low RF harmonics to the input point of the power amplifier.

To the right is the 5000 watt cubicle. This is a single stage push-pull amplifier with its 3 phase, full wave power

supply, control circuits and metering self-contained. A VSWR meter indicates power output and standing wave ratio to the transmission line. The tank components and power tubes are enclosed in a non-ferrous housing. This provides air cooling to both tubes and components. Electrically it should be noted that both driver and power amplifiers are at fundamental frequency. This aids greatly in lowering spurious radiation and longer tube life whereas tubes doubling or tripling frequency require greater power input.

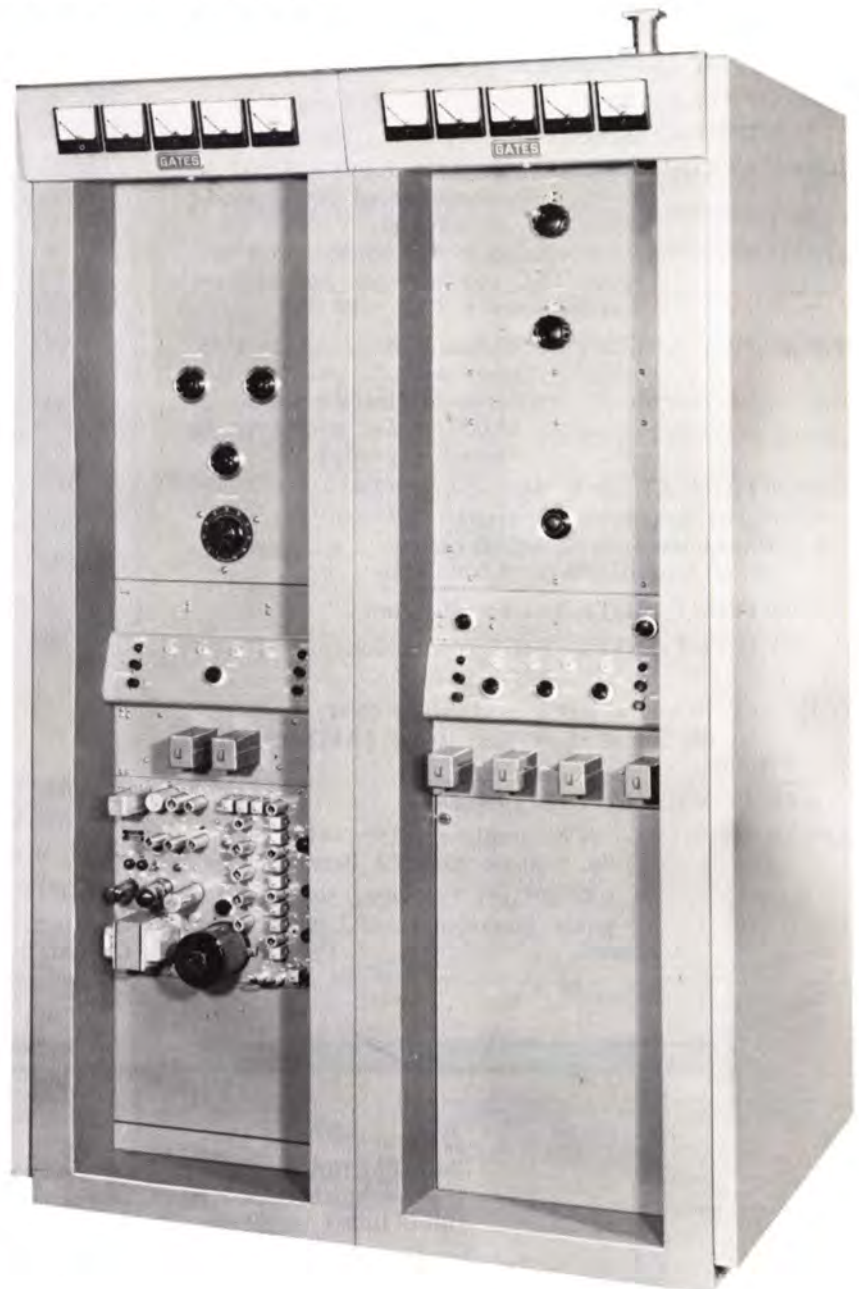

**MODEL FM-5B 5000 WATT FM TRANSMITTER**



Refinements are expected in new equipment. The FM-5B has these refinements. Diaphragm air pressure switches replace damper type disconnects in protecting air flow to valuable power tubes. Generosity in the relay complement contributes to equipment and personal protection as well as ease in adopting remote control. The 5KW blower develops 3 1/2" static pressure, far in excess of needs. The blower is shock mounted for lower aural and transmitted noise. Air intakes are provided with replaceable filters that may be replaced without transmitter shut down.

Rear doors are of the slip on/off type, allowing full rear access without door obstruction during maintenance. All components are quickly accessible and ease of servicing is obvious at a glance.

An external notch or Tee filter is provided and illustrated herein. This filter, of coaxial standards, connects between the transmitter output coaxial connector and the transmission line. This is a quarter wave stub to substantially reduce the second harmonic that may otherwise fall in the TV band. Other harmonics are attenuated in the transmitter proper.

Stability in FM broadcasting equipment is tantamount to reliability. Thus, stability was the engineering objective during FM-5B research and design. The driver amplifier is actually the Gates FM-250B, 250 watt FM transmitter. It may be operated as such. The 5000 watt power amplifier receives its drive at fundamental frequency and at low impedance. This stability feature alone greatly reduces interaction such as might be caused by antenna icing. With the 5000 watt amplifier as a single stage unit in a separate cubicle or cabinet, much more attention can be given to effective tank circuit shielding and component efficiency.

**MODEL FM-5B 5000 WATT FM TRANSMITTER**



Heart of all Gates FM broadcast transmitters is the M-5534 exciter with direct crystal controlled oscillator, phase shift modulator with pulse timing techniques, and 10 watts output. Power supply is self-contained. During research period, extreme attention was paid to intermediate frequency coil design, circuit constants and stability. All Gates exciters will operate multiplex by purchasing Gates multiplex sub-generators either now or later.

Pioneers in multiplexing equipment, Gates discarded the heterodyne system and developed the direct system of multiplexing that utilizes each sub-channel on the direct sub-frequency. The output of the multiplex generator is phase modulated to arrive at program content. The Gates system of multiplexing does not require crystal controlled sub-channel generators and plugs into the Gates M-5534 exciter.

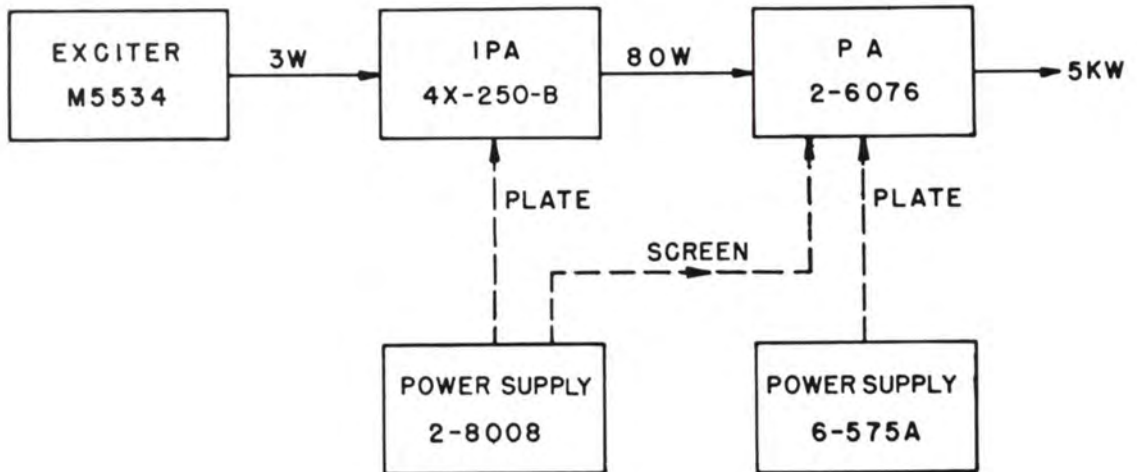

**BLOCK DIAGRAM FM-5-B  
5 KW FM BROADCAST TRANSMITTER**

## MODEL FM-5B 5000 WATT FM TRANSMITTER

### SPECIFICATIONS

**POWER OUTPUT:** Rated 5000 watts, capable 5500 watts.

**FREQUENCY RANGE:** 88-108 Mc. (as ordered).

**FREQUENCY STABILITY:**  $\pm 0.001\%$ .

**RF OUTPUT:** 50 ohms to type  $1\frac{5}{8}$ " RF flange female connector.

**FREQUENCY SWING:**  $\pm 75$  Kc equals 100% modulation.

**RF HARMONICS:** All are 60 db or better.

**AUDIO FREQUENCY RESPONSE:** Within one db of standard 75 microsecond pre-emphasis curve or flat  $\pm 1$  db, 50-15,000 cycles, as desired (or if preference, state when ordering).

**AUDIO DISTORTION:** 1% or less 50-15,000 cycles,  $\frac{1}{2}\%$  or less 100-10,000 cycles. 1% or less 10,000-15,000 cycles.

**AUDIO INPUT IMPEDANCE:** 600 ohms.

**AUDIO INPUT LEVEL:** +10 dbm to  $\pm 2$  db.

**NOISE:** 65 db or better below 100% modulation (FM)  
60 db or better below 100% modulation (AM)

**PRIMARY POWER:** 230 volts, 50/60 cycles.

**POWER CONSUMPTION:** 11,900 watts.

**TUBES:** (7) 6AU6, (6) 8008, (3) 12AX7, (3) 6J6, (2) OA2, (2) 6076, (2) 866A, one each 6360, 6AQ5, 6080, GZ34/5AR4, 4X250B, 12AT7.

**TOTAL NUMBER OF TUBES:** 31

**TOTAL TUBE TYPES:** 13

**CONNECTOR REQUIRED:**  $1\frac{5}{8}$ " flange RF male.

**SIZE:** 78" high, 51" wide,  $36\frac{1}{2}$ " deep.

**WEIGHT:** 1800 lbs., unpacked; 2375 lbs., packed.

**CUBAGE:** 78 cu. ft., total shipment.

**FINISH:** Medium gloss gray with escutcheons in black and hardware chrome.

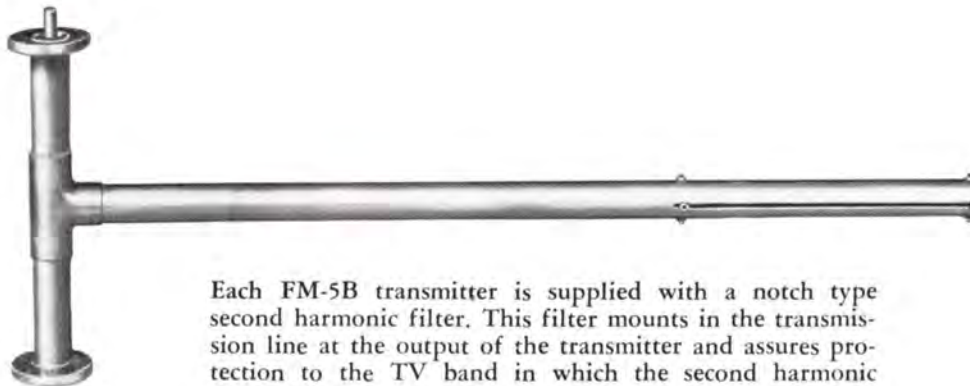

Each FM-5B transmitter is supplied with a notch type second harmonic filter. This filter mounts in the transmission line at the output of the transmitter and assures protection to the TV band in which the second harmonic might fall.

### ORDERING INFORMATION

5000 watt FM broadcast transmitter, with tubes and one crystal and oven .....	FM-5B
Spare 100% tube complement for above .....	TK-313
FCC tube complement (required FCC spares) .....	TK-319

# 1000 WATT FM TRANSMITTER

Model FM-1B  
(MULTIPLEXING OPTIONAL)

In the design of any FM transmitter, due to VHF frequencies and the always potential unattended operation, the word stability is foremost in the design engineer's mind. Field experience from two other 1 KW models in the past ten years and advanced technology in high frequencies, partially the result of guided missile transmitters researched and built by Gates, has resulted in what we believe is an advanced design.

The M5534 exciter, described in detail in this catalog, employs a phase shift modulator with pulse timing techniques. Tube change from off the shelf tubes does not require realignment to retain top-grade performance. Multiplexing may be plugged in at any time. The exciter develops a full 10 watts output.

From the exciter a push-pull IPA stage with 6146 tubes drives the final P.A. 4-400A tubes to develop an easy 1000 watts. Coupling between exciter to driver and driver to final amplifier is at 51 ohms. This eliminates trouble causing high impedance coupling and again emphasizes stability. Both the driver and power amplifier stages are totally shielded in a non-ferrous housing and the entire power amplifier section including components is in an air chamber. This chamber is protected by a diaphragm type air pressure switch disconnecting high voltage in case of air failure. A low pass filter is incorporated to attenuate both harmonics and spurious radiation, vital in today's crowded use of the radio frequency spectrum. Relay complement is most complete for both equipment and personnel protection. Use of remote control is a simple and routine attachment, if desired.

There are dual power supplies for low and high voltage. Cabinet is of 16 gg stretcher level steel, resistance welded and attractively finished in two tones of gloss gray. Rear door is lift off type  $\frac{3}{4}$  full length. Front is recessed to protect extruding front panel equipment. Metering includes a VSWR output meter for reading power and standing wave ratio. Air intake is filtered and filters may be easily removed for cleaning.



Heart of all Gates FM broadcast transmitters is the M5534 exciter with direct crystal controlled oscillator, phase shift modulator with pulse timing techniques and 10 watts output. Power supply is self-contained. During research period, extreme attention was paid to intermediate frequency coil design, circuit constants and stability. All Gates exciters will operate multiplex by purchasing Gates multiplex sub-generators either now or later.

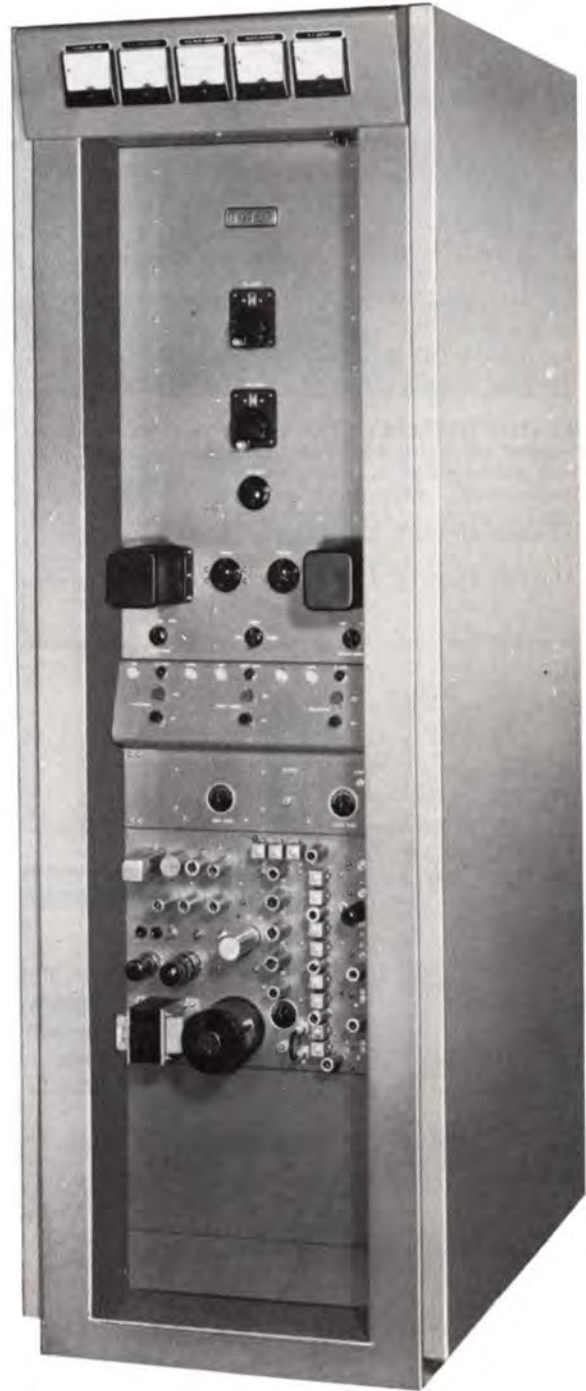

**MODEL FM-1B SPECIFICATIONS**

**POWER OUTPUT:** Rated 1000 watts, capability 1100 watts.

**FREQUENCY RANGE:** 88-108 Mc (as ordered).

**FREQUENCY STABILITY:** 0.001%.

**RF OUTPUT:** 50.0 ohms into a 7/8" coaxial flange connector.

**FREQUENCY SWING:** ±75 Kc equals 100% modulation.

**RF HARMONICS:** Suppression of harmonics meets or exceeds FCC requirements.

**AUDIO FREQUENCY RESPONSE:** Within 1 db of standard 75 microsecond pre-emphasis curve or flat ±1.0 db from 50-15,000 cycles, as desired. (If preference, state when ordering.)

**AUDIO DISTORTION:** 1% or less 50-100 cycles; 0.5% or less 100-10,000 cycles; 1% or less 10,000-15,000 cycles.

**AUDIO INPUT IMPEDANCE:** 600 ohms.

**AUDIO INPUT LEVEL:** 600 ohms +10 dbm ±2 db.

**NOISE:** 65 db below 100% modulation (FM); 50 db below equivalent 100% modulation (AM).

**PRIMARY POWER:** 230 volts, 50/60 cycles, single phase grounded neutral three wire.

**POWER CONSUMPTION:** 3800 watts.

**TUBES:** (7) 6AY6 oscillator, (3) 12AX7 multipliers, (3) 6J6, (2) OA2, (2) 6146, (2) 4-400A, (2) 8008, and one each 6360, 6AQ5, 6080, GZ34/5AR4, 5R4GYA and 12AT7.

**TOTAL NUMBER TUBES:** 27

**TOTAL TUBE TYPES:** 13

**CONNECTOR REQUIRED:** 7/8" E1A flange.

**SIZE:** 78" high, 27" wide, 36 1/2" deep.

**WEIGHT:** 880 lbs. unpacked; 1140 lbs. packed.

**CUBAGE:** 44 cu. ft., total shipment.

**FINISH:** Two-tone medium gloss gray.

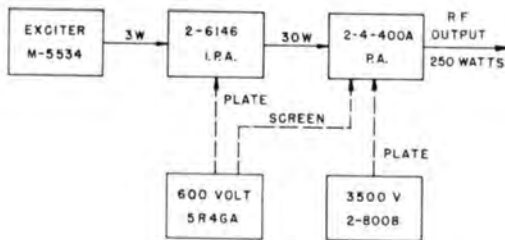

BLOCK DIAGRAM FM-1-B  
J-KW-FM  
BROADCAST TRANSMITTER



Pioneers in multiplexing equipment, Gates discarded the heterodyne system and developed the *direct system* of multiplexing that utilizes each sub-channel on the direct sub-frequency. The output of the multiplex generator is phase modulated to arrive at program content. The Gates system of multiplexing does not require crystal controlled sub-channel generators and plugs in the Gates M5534 exciter.

**ORDERING INFORMATION**

- FM transmitter, 1000 watts with tubes, one crystal and oven ..... FM-1B
- Spare 100% tube complement for above ..... TK-312
- FCC tube complement (required FCC spares) ..... TK-318

# 250 WATT FM TRANSMITTER

Model FM-250B

(MULTIPLEXING OPTIONAL)

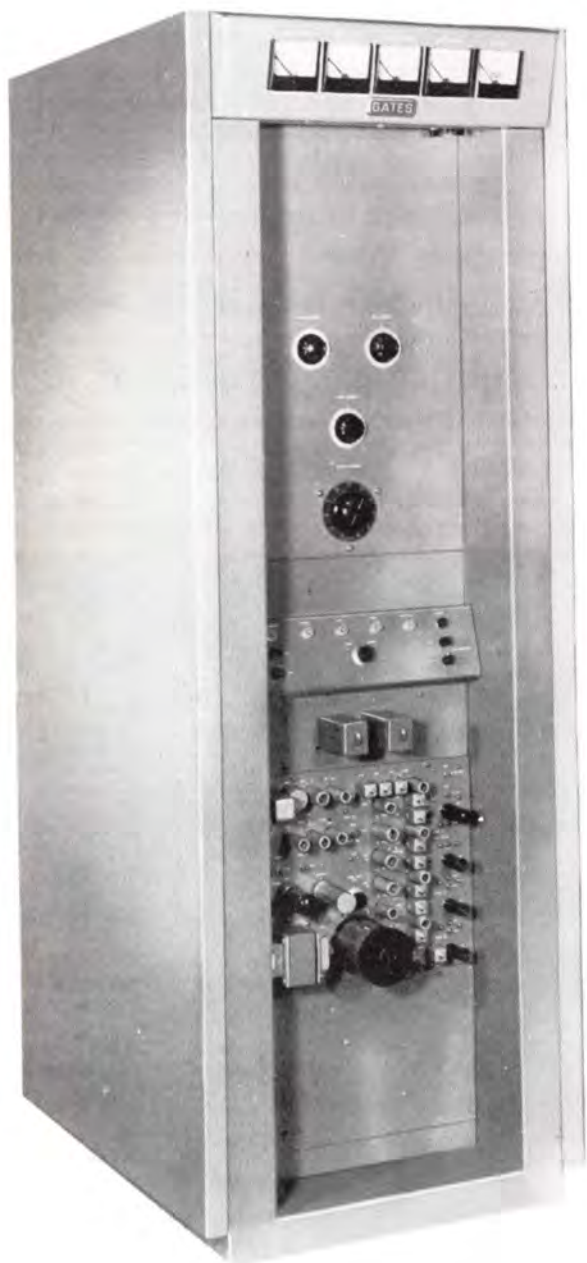

Since the very beginning of FM broadcasting, Gates engineers have applied continual product research. The FM-250B transmitter incorporates the results of this research. Because above normal VSWR will nearly always affect stability, particular attention has been paid to retain stability under abnormal conditions such as icing on the antenna. An improved tank circuit, a complete non-ferrous shield housing for the final amplifier combined with the M5534 exciter wherein the 10 watts output from this exciter drives the final amplifier direct, results in top stability, so necessary for good everyday service with minimum technical attention.

The superiority of the Gates M5534 exciter is emphasized by noting that either single or dual channel multiplexing is possible at any time by simply plugging in the multiplex equipment. Exact basic exciter design is mandatory in multiplexing and complementary in monaural service. The exciter and multiplexing equipment are described in detail in this catalog.

Interesting to note is that the power amplifier stage is single ended. Metering is complete including a VSWR meter in the transmission line to read both power output and standing wave ratio. The relay complement is complete for both protection and ease in attaching remote control. No circuit breakers are employed, important in unattended operation. A diaphragm type air pressure switch immediately disconnects high voltage in case of air failure. Air intake is filtered.

Cabinet design is sturdy with lift off rear door and front panels recessed to protect extruding components. As the FM-250B transmitter is the driver for the Gates FM-5B 5000 watt transmitter, the possibilities for later expansion are without price penalty. The FM-250B transmitter is available on special order in frequency ranges of 40-88 Mc and 108-220 Mc. The 88-108 Mc FM band is standard stock equipment.



MULTIPLEXING UNIT — OPTIONAL

Pioneers in multiplexing equipment, Gates discarded the heterodyne system and developed the *direct system* of multiplexing that utilizes each sub-channel on the direct sub-frequency. The output of the multiplex generator is phase modulated to arrive at program content. The Gates system of multiplexing does not require crystal controlled sub-channel generators and plugs in the Gates M5534 exciter.

**MODEL FM-250B SPECIFICATIONS**

**POWER OUTPUT:** Rated 250 watts, capability 280 watts.  
**FREQUENCY RANGE:** FM-250B (Broadcast), 88-108 Mc. FM-250C (Communications), 40-88 Mc.  
**FREQUENCY STABILITY:** 0.001% via temperature controlled crystal.  
**RF OUTPUT:** 50 ohms to coaxial line to Type N connector.  
**FREQUENCY SWING:** FM-250B,  $\pm 100$  Kc (75 Kc considered 100% modulation).  
 FM-250C, available as ordered.  
**RF HARMONICS:** Suppression meets or exceeds all FCC requirements, with second harmonic filter in-built.  
**FREQUENCY RESPONSE:** Within 1.0 db of standard 75 microsecond pre-emphasis curve or flat  $\pm 1.0$  db, 50-15,000 cycles as desired (if preference, state when ordering).  
**DISTORTION:** 1% or less 50-100 cycles.  
 0.5% or less 100-10,000 cycles.  
 1% or less 10,000-15,000 cycles.

**AUDIO INPUT IMPEDANCE:** 600 ohms.  
**AUDIO INPUT LEVEL:** + 10 dbm,  $\pm 2$  db.  
**NOISE:** 65 db below 100% modulation (FM). 50 db below equivalent 100% AM modulation.  
**PRIMARY POWER:** 115 volts, 50/60 cycles.  
**POWER CONSUMPTION:** 800 watts.  
**TUBES:** (7) 6AU6, (3) 12AX7, (3) OA2, (2) 866A and one each 6360, 6AQ5, 6080, GZ34/5AR4, 4X250B, 12AT7.  
**NUMBER TUBES:** 22.  
**TOTAL TUBE TYPES:** 11.  
**RF CONNECTOR REQUIRED:** Type N male.  
**SIZE:** 78" high, 27" wide, 36-1/3" deep. If end bells removed, width reduces to 24".  
**WEIGHT:** Net 510 lbs. Packed 820 lbs.  
**CUBAGE:** 44.  
**FINISH:** Medium gloss gray with escutcheons in black and trim in chrome.

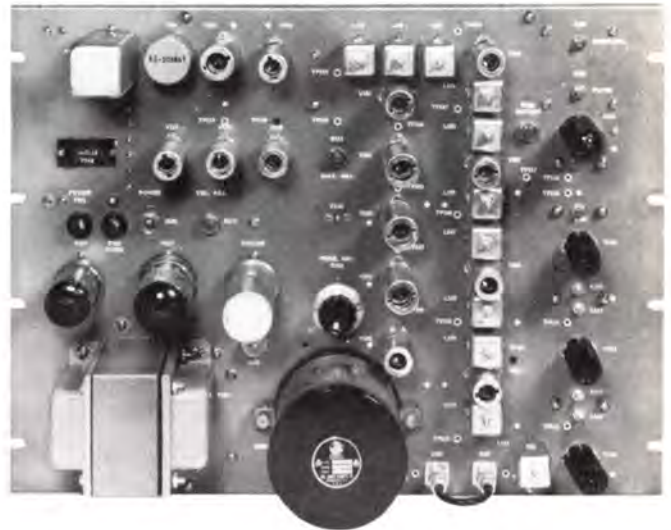
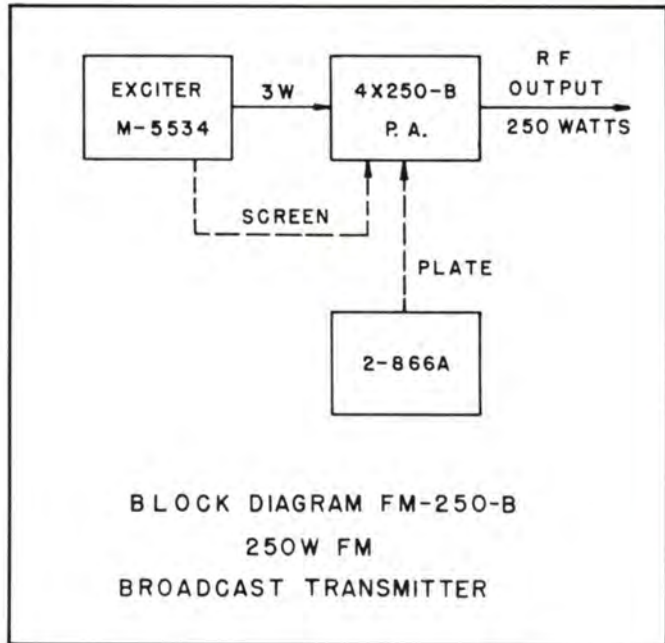

Heart of all Gates FM broadcast transmitters is the M5534 exciter with direct crystal controlled oscillator, phase shift modulation or with pulse timing techniques and 10 watts output. Power supply is self-contained. During research period, extreme attention was paid to intermediate frequency coil design, circuit constants and stability. All Gates exciters will operate multiplex by purchasing Gates multiplex sub-generators either now or later.

**ORDERING INFORMATION**

- FM transmitter, 250 watts, with tubes, one crystal and oven .... **FM-250B**
- Spare 100% tube complement for above ..... **TK-311**
- FCC tube complement (required FCC spares) ..... **TK-317**



# 10 AND 50 WATT FM TRANSMITTERS

Models BFE-10B & BFE-50B

(MULTIPLEXING OPTIONAL)

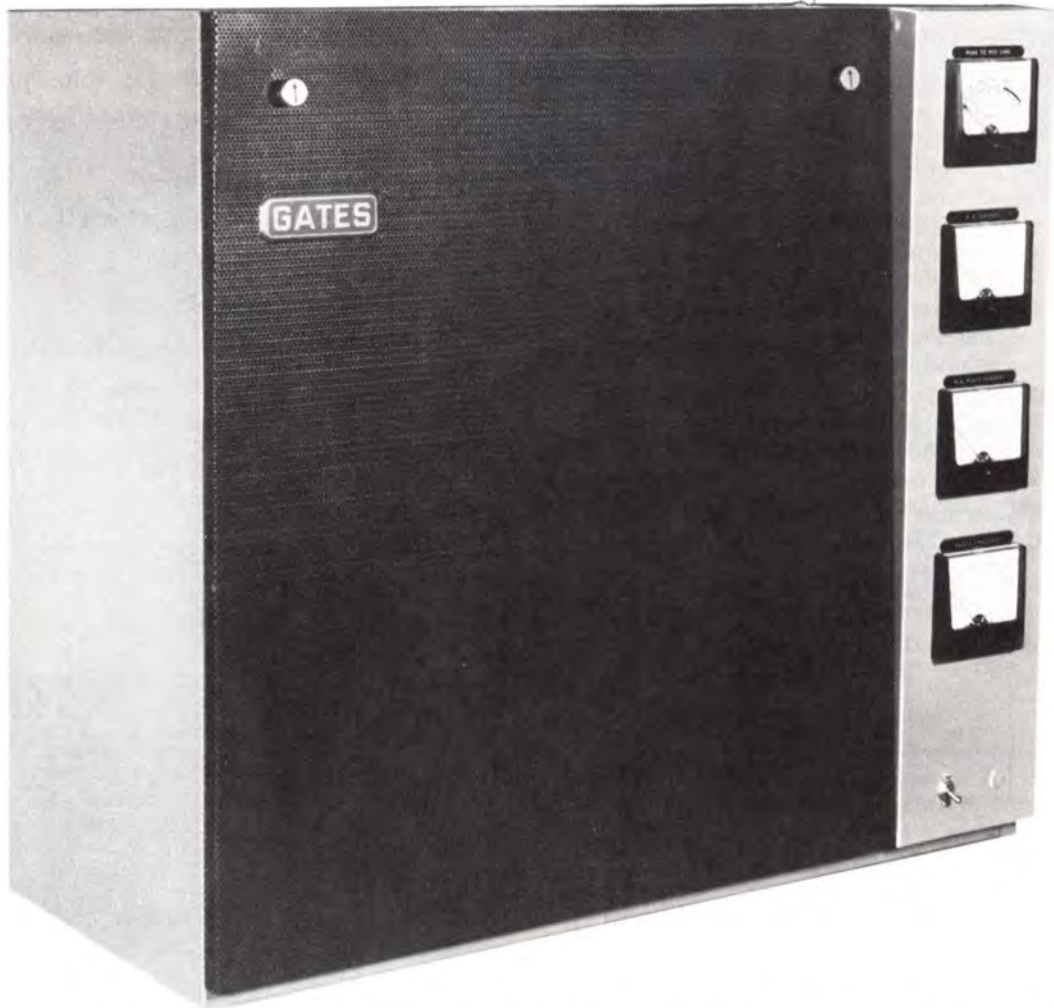

**Model BFE-10B:** FCC approved for educational FM broadcasting but used in all applications where 10 watts output is sufficient. Single or dual channel multiplexing optional either now or when required.

**Model BFE-50B:** Similar to the BFE-10B FM transmitter but with 50 watts amplifier added to provide 50 watts output. Single or dual channel multiplexing is optional.

Modern in both electrical and mechanical design, these two transmitters provide unusually low distortion and wide frequency response. Along with other metering (see Specifications, opposite page), an audio level meter indicates modulation level. This feature makes the transmitter 100% complete without external accessories other than antenna and audio equipment. Heart of this equipment

is the M5796 exciter, utilizing a phase shift modulator with pulse techniques. The upgrading demanded because of multiplexing adds much to monaural performance as well.

Construction is pleasing to the eye and unusually convenient to service. The full length, perforated front grill removes quickly by loosening two thumb nuts to reveal tubes, adjustments and crystal oven. There is a full length slip off rear door. The depth of only 14" is a space saver.

Multiplexing, either single or dual sub-channels, is available and is fully described on another page. In the BFE-50B fifty watt model, the 50 watt P.P. 6146 amplifier and its separate power supply, mount directly above the exciter.

## 10 WATT AND 50 WATT SPECIFICATIONS

**POWER OUTPUT:** BFE-10B, ten watts. BFE-50B, fifty watts.

**FREQUENCY RANGE:** 88-108 Mc, as ordered.

**STABILITY:** 0.001% or better.

**RF OUTPUT:** 51 ohms (Type N connector).

**FREQUENCY SWING:**  $\pm 100$  Kc ( $\pm 75$  Kc = 100% modulation in FM broadcasting).

**RF HARMONICS:** Suppression meets or exceeds all FCC requirements.

**RESPONSE:** Within 1 db of standard 75 microsecond pre-emphasis curve or flat  $\pm 1$  db, 50-15,000 cycles, as desired. (If preference, state when ordering).

**DISTORTION:** 1% or less 50-100 cycles.  $\frac{1}{2}$ % or less 100-10,000 cycles. 1% or less 10,000-15,000 cycles.

**INPUT:**  $\pm 10$  dbm  $\pm 2$  db at 600 ohms impedance.

**NOISE:** 65 db below 100% modulation (FM). 50 db below equivalent 100% AM modulation.

**POWER:** 115 volts, 50/60 cycles.

**POWER CONSUMPTION:** BFE-10B, 120 watts. BFE-50B, 230 watts.

**TUBES:** BFE-10B — (7) 6AU6, (3) 12AX7, (3) 6J6, (2) OA2, and one each 6AQ5, GZ34/5AR4, 6080, 6360, 12AT7.

BFE-50B — Same as above, with (2) 6146 and (1) 5R4GYA tubes added.

**TOTAL TUBES:** 15

**TOTAL TUBE TYPES:** 9 (BFE-10)

**CONNECTOR REQUIRED:** Type N Female.

**SIZE:** 26 $\frac{1}{2}$ " high, 28" wide, 14" deep.

**WEIGHT:** BFE-10B — packed 115 lbs. BFE-50B — packed 165 lbs.

**CUBAGE:** BFE-10B — 8.5. BFE-50B — 8.5.



Front View (cover removed) of BFE-10B Ten Watt Model



Front View (cover removed) of BFE-50B Fifty Watt Model

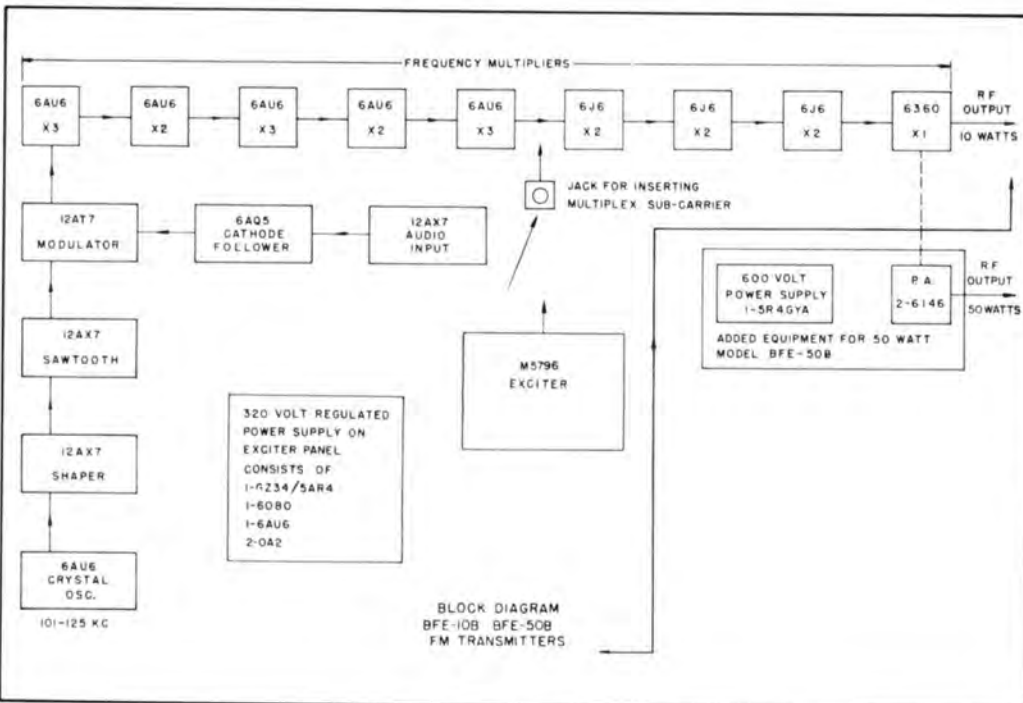

### ORDERING INFORMATION

Model BFE-50B FM broadcast transmitter with tubes and crystal ..... BFE-50B

Model BFE-10B FM broadcast transmitter with tubes and crystal ..... BFE-10B

FCC tube complement (required FCC spares)  
(BFE-10B) TK-359  
(BFE-50B) TK-360

# MULTIPLEXING EQUIPMENT FOR FM

Single and Dual Sub-Channels

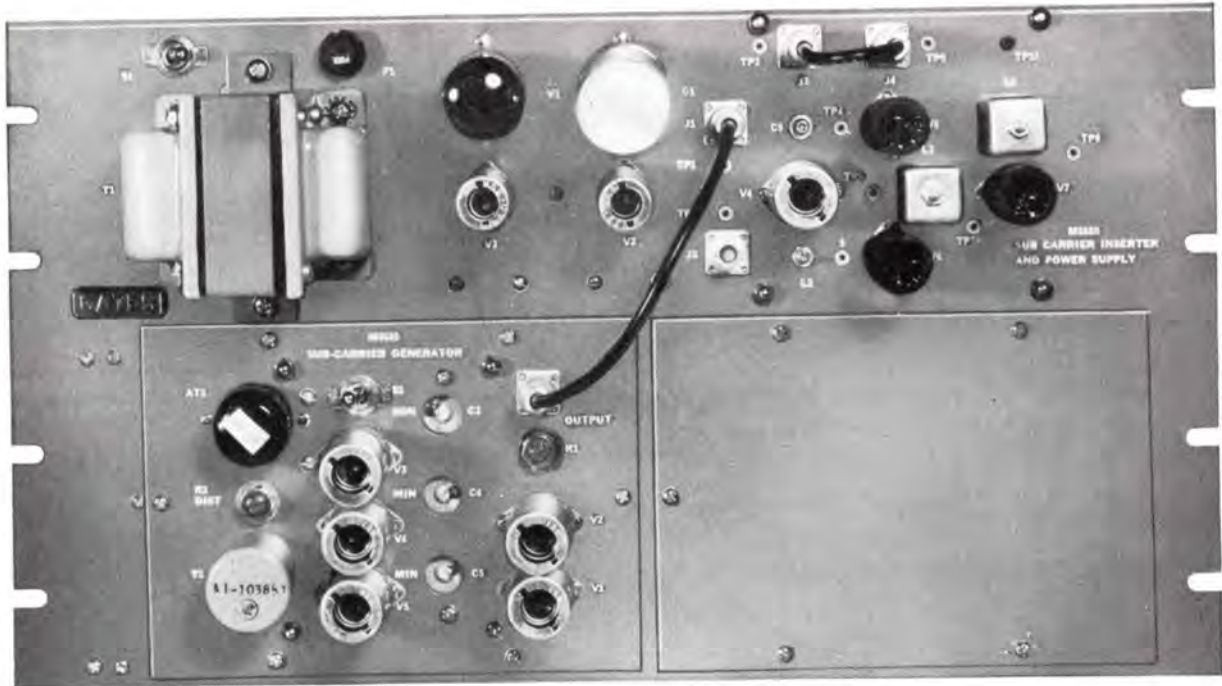

Gates sub-carrier inserter with single sub-carrier generator for FM broadcasting on main and one sub-carrier channel. Note space provided for second sub-channel generator that may be installed now or later (See illustration).

By the reason of pioneering in multiplexing for FM broadcasting, the current Gates multiplexing system for single and dual sub-channels instead of a near rack full of equipment, is a compact, non-complex, highly effective and reliable system.

The complete multiplex system for one or two sub-channels is built on a panel 19" x 10 $\frac{1}{2}$ " in size. This panel consists of a sub-carrier inserter, power supply and either one or two sub-carrier generators for multiplexing. The sub-carrier inserter consists of a phase splitter, balanced phase modulator and amplifier. There is no effect upon main carrier modulation caused by passage through the sub-carrier inserter. The sub-carriers, either one or dual, which might be at 41 Kc and 67 Kc, are inserted on the main carrier by phase modulation. Thus, program material placed on the sub-carrier/s by frequency modulation in the sub-carrier generators can then be detected at the receiver end by the sub-carrier receiver or adaptor.

Earlier multiplex systems employed a heterodyne system to arrive at a sub-channel frequency. This requires extreme care in alignment as well as continued effort to keep aligned. Misalignment developed so-called birdies in the program content. Also, the providing of a second sub-carrier became very complex and costly along with even

greater alignment problems. In Gates multiplexing, the sub-channel frequency is generated within the sub-channel generator and is then phase modulated to arrive at program content. These sub-channel generators need not be crystal controlled as the discriminators in the receivers are always broad enough to permit 1% stability. This eliminates any possibility of heterodyne signals (birdies) in the program content. It also makes more than one sub-carrier not only practical but almost ridiculously simple.

Gates multiplexing systems are successfully in use today in numerous FM stations. This is mentioned to assure the reader that the contents herein is not theory. The simplicity of Gates multiplex, contrasted to earlier systems, will logically cause the prospective user to ponder. The answer partially is that Gates multiplex must be used with the new Gates M-5534 main carrier exciter. Both exciter and multiplex are a compatible engineering group of equipment. The advanced design of the exciter contributes to the good performance of Gates multiplex equipment. The balance of the answer is in the specifications on the opposite page. It is well to state that Gates does not hesitate to recommend dual sub-channels as practical and highly workable. This is perhaps the best endorsement of the good results where in other systems the second sub-channel has caused some engineering problems.

## MULTIPLEXING EQUIPMENT SPECIFICATIONS

**FREQUENCIES:** Any sub-carrier frequency between 25 Kc and 75 Kc. The sub-carrier receivers currently on the market indicate 41 Kc for the first sub-channel and 67 Kc for the second. Other models suggest 50 Kc for single sub-carrier use. State desires when ordering.

**FREQUENCY STABILITY:** 1.0% or less. Receiver discriminator circuits accept this percentage as a necessary tolerance.

**OSCILLATOR:** Phase shift.

**MODULATION:** Phase.

**MODULATION CAPABILITY:** 30% sub-carrier modulation of main carrier. In average conditions held to about 10%.

**SUB-CARRIER SWING:** (due to modulation) Max;  $\pm 8$  Kc. 100% modulation;  $\pm 5$  Kc. (See Note below)

**AUDIO INPUT:** 600 ohms at approximately +10 dbm.

**NOTE 1:** Crosstalk measurements are based on factory tests with recognized measuring equipment. As crosstalk can also be generated in the receiver, customer should also check receiver specifications to assure good systems performance.

**FREQUENCY RESPONSE:** (one or two sub-channels)  $\pm 2$  db, 50-7500 cycles.

**DISTORTION:** 3% or less at 100% modulation.

**FM NOISE:** Down 60 db or better with ref. to 100% modulation ( $\pm 5$  Kc swing). Measured with main carrier removed.

**CROSSTALK:** Down 50 db or better with main carrier having sine wave modulation at 70%. (See Note below).

**TUBES:** For single sub-carrier; (2) 6BE6, (4) 12AX7, (1) 6AU6, (2) 12AY7, (2) OA2, and (1) 5Z34/5AR4.

For two sub-carriers; (2) 6BE6, (7) 12AX7, (4) 12AY7, (1) 6AU6, (2) OA2, and (1) 5Z34/5AR4.

**SIZE:** 19" wide, 10 $\frac{1}{2}$ " high, 3 $\frac{3}{4}$ " in front of panel and 4" behind panel including dust cover. This panel includes sub-carrier inserter and space for one or two sub-carrier generators.

**NOTE 2:** FCC requirements state the arithmetic sum of all multiplex sub-carriers shall not exceed 30% modulation of the main carrier. Tests indicate modulating the main carrier with a sub-carrier in excess of 10% ( $\pm 7\frac{1}{2}$  Kc) has little effect on the signal to noise ratio.



Front and rear view of sub-carrier generator. Illustration on previous page shows one sub-carrier generator installed on the sub-inserter panel with space for second sub-carrier generator provided. Sub-carrier generators are identical other than frequency of operation.

### ORDERING INFORMATION

Complete single sub-carrier multiplex equipment including M-5688 sub-carrier inserter, one M-5688 sub-carrier generator and tubes ... M-5633A

Complete dual sub-carrier multiplex equipment including M-5688 sub-carrier inserter, two M-5688 sub-carrier generators and tubes ... M-5633B

**NOTE 3:** Above multiplex equipment must be used with Gates M5534 FM main channel exciter.

**NOTE 4:** When ordering, state sub-carrier frequency. This is usually obtained by choice of receivers which are designed for a specific sub-carrier frequency such as 41 Kc, 50 Kc, 67 Kc, etc.

# FM EXCITER MODEL M-5534

(MULTIPLEXING OPTIONAL)

The Gates M-5534 exciter for FM broadcasting in the 80-108 Mc band is offered to FM broadcasters for modernizing existing FM transmitters. With this exciter, multiplexing may be either immediately purchased or added at a future date. As the exciter output is 10 watts at 50 ohms and at operating frequency, the adaption to any existing transmitter is easily done. It may be mounted in a nearby rack cabinet and coupled to the transmitter with RG-8/U cable where it is not convenient to alter the existing transmitter.

Because of multiplexing, Gates engineers designed an entirely new exciter having definitely superior characteristics, whether or not multiplexing is employed. Unusual attention was paid to intermediate amplifier design. The use of pulse techniques in a phase shift modulator eliminates costly special tubes. In fact, tubes are standard receiving type and may be replaced with off the shelf tubes and full performance specifications will be met without retuning or alignment. FM broadcasters installing the Gates M-5534 exciter have reported very noticeable improvement in transmission quality and most important, complete freedom from high maintenance cost and touchy problems that accompanied earlier FM designs.

As the exciter power supply is self-contained, electrical installation involves attachment of audio, AC, and output terminations. When Multiplex is added, it becomes a plug-in operation. The M-5534 exciter is supplied tuned to customer's frequency.

It is believed the M-5534 exciter may be attached to any existing FM transmitter regardless of make. With 10 watts output, more than sufficient drive should be available for the succeeding R.F. power stage in most transmitters. Where the drive is in excess of requirements, this can be adjusted downward within the exciter itself. It can be said with reasonable accuracy that the trouble point of earlier FM transmitter designs, where existing, was in the lower level stages.



The Gates M-5534 exciter in this respect will offer complete modernization, signal quality improvement and solid reliability. As the M-5534 exciter is used in all new Gates FM transmitters and are fully FCC approved, the addition of this exciter to existing FM equipment should offer no problems as related to FCC approval of the modification.

## SPECIFICATIONS

POWER OUTPUT: 0-10 watts (variable by control).  
 FREQUENCY RANGE: 88-108 Mc (supplied on customer's frequency).  
 RF OUTPUT: 50-72 ohms.  
 OSCILLATOR: Direct crystal control (crystal in temperature controlled oven supplied).  
 STABILITY:  $\pm 0.001\%$ .  
 MODULATION: Phase shift, using pulse techniques.  
 AUDIO: 600 ohms at approximately +10 db.  
 RESPONSE: Within 1 db of 75 microsecond pre-emphasis curve or flat  $\pm 1$  db. 50-15,000 cycles.

DISTORTION (at 100% mod.): 0.5% 100-10,000 cycles.  
 1% or less 50-100 cycles and 10,000-15,000 cycles.  
 NOISE: (FM) 65 db below 100% modulation.  
 NOISE: (AM) 60 db below equivalent 100% amplitude modulation.  
 POWER INPUT: 117 volts AC 50/60 cycles at approximately 120 watts.  
 TUBES: (7) 6AU6, (3) 6J6, (3) 12AX7, (2) OA2, and one each 6AQ5, 12AT7, GZ34/5AR4, 6080 and 6360.  
 SIZE: 19" wide, 14" high, 5" front panel component extension. 3" behind panel includes dust cover.  
 MULTIPLEXING: See Bulletin 104-A for complete information.

## ORDERING INFORMATION

Complete exciter with self-contained power supply, crystal and oven and 100% tube complement ..... **M-5534**  
 (Please state FM frequency and type transmitter when ordering.)

# 5000 WATT VHF TELEVISION TRANSMITTER

Model BT-5C

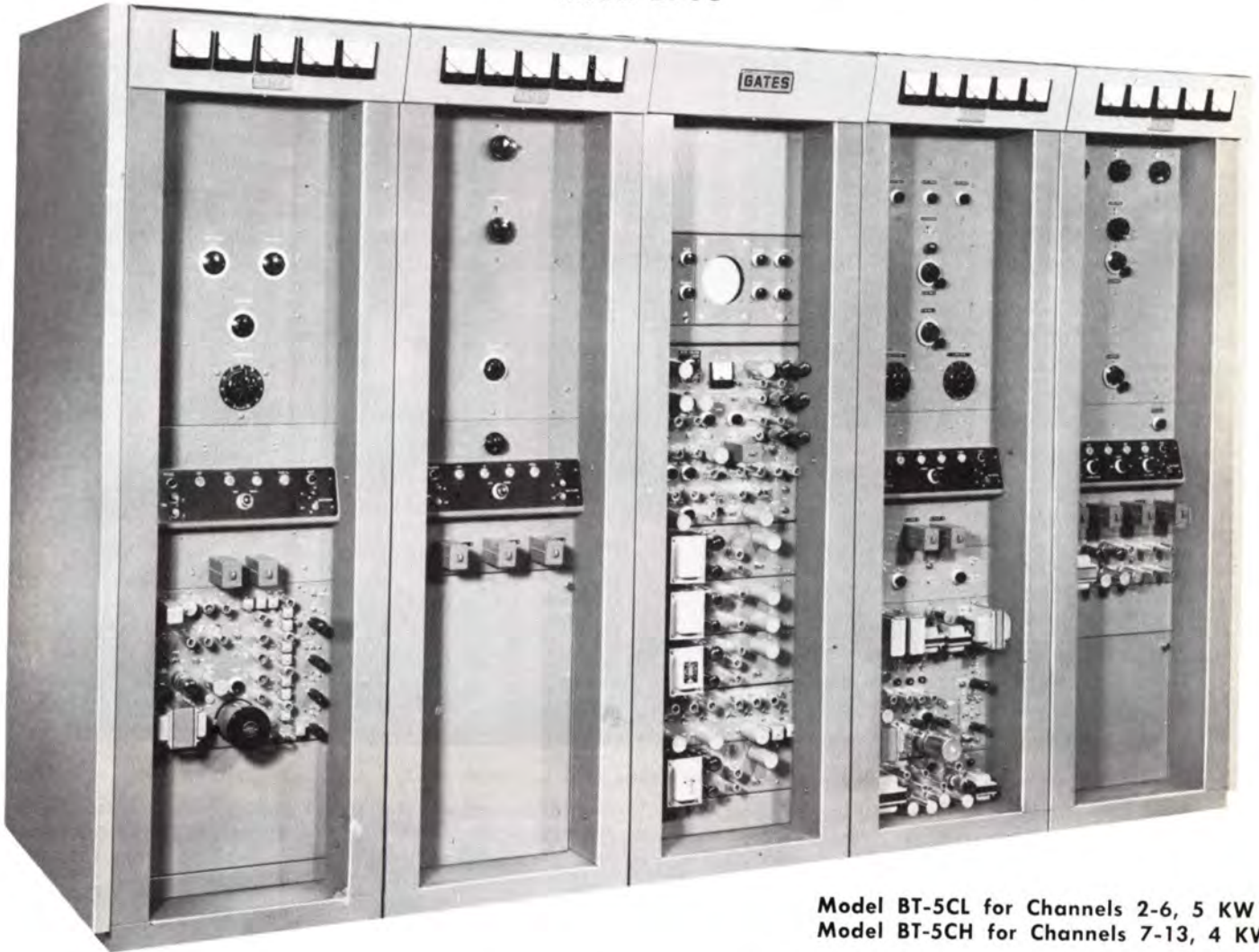

Model BT-5CL for Channels 2-6, 5 KW  
Model BT-5CH for Channels 7-13, 4 KW

The Gates BT-5C is an entirely new five kilowatt designed for the most exacting color and monochrome television transmission. Completely self-contained (vestigial sideband filter mounted externally), including blowers and power components, the BT-5C requires total floor space of only 10 feet by 3 feet. The two aural cabinets and the three visual cabinets are mounted together as one complete transmitter — the aural being the two left hand cubicles and the visual, the remaining three. It is possible to supply separate side panels for both sections so the transmitters may be mounted in operating position separate from one another, however, to make a concise and complete transmitter, it is recommended that all five cubicles be mounted together.

Separate high voltage power supplies are provided for both the aural and visual transmitter. The BT-5C also includes a new and improved video modulator with keyed clamping and automatic switch over to AC coupling with reduced carrier power in case of sync or program failure.

The visual transmitter is grid modulated in the 500 watt visual driver by a dynamic cathode load modulator circuit. Video modulator of the new transmitter is equipped with RF bias failure alarm lamp, test meter, and an abundance of front panel test jacks. Rated power output is 5.0 Kw peak visual. The BT-5C uses 6076 tetrodes in final amplifier of both visual and aural transmitters.

The aural section is FCC rated at 2500 watts, but is capable of as much as 3 Kw. On most channels, operating characteristics generously exceed many FCC maximum requirements. The exciter employs a phase shift modulator with pulse timing techniques and delivers approximately 4 watts at the output. This drives a single IPA stage which drives the 2500 watt amplifier. Three power supplies are incorporated in the aural section: (1) low voltage, (2) 1500 volt intermediate, and (3) 5000 volt high voltage. Use of a single ended power amplifier stage combined with only one IPA stage between the exciter and power amplifier assures a stable circuitry. When added to a conserva-

**BT-5C 5000 WATT VHF TELEVISION TRANSMITTER**

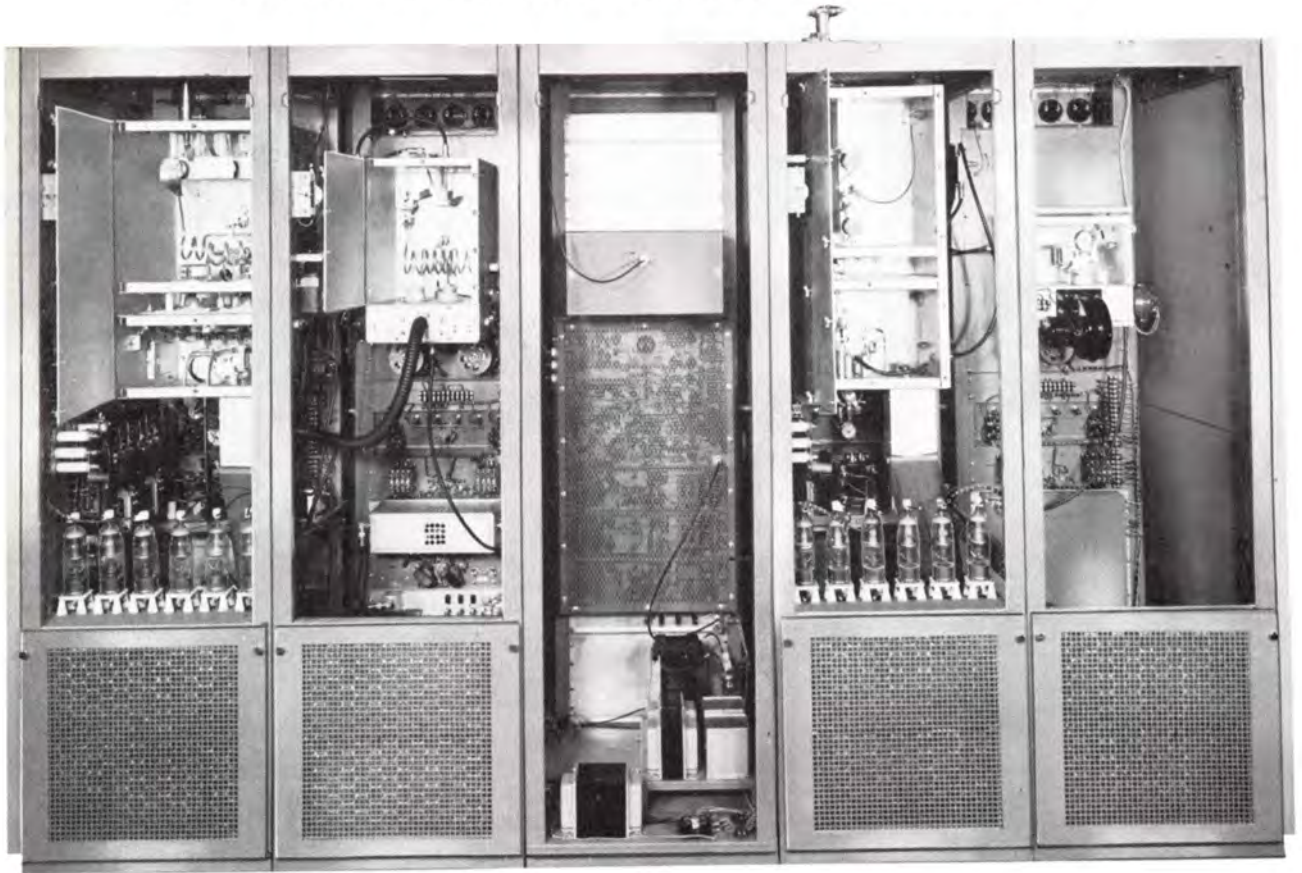

Rear view with monochrome filter and blank panel.

tively rated tube complement and rigid construction, trouble-free performance is assured.

Another important feature of the aural transmitter is the lack of frequency multiplication after the exciter. This aids in eliminating spurious frequencies and gives protection to tube life as power type tubes doubling or tripling in frequency are not always operated under their most stable and life lengthening conditions.

The 2.5 Kw power amplifier and the IPA driver amplifier are totally enclosed, both tubes and components, in a non-ferrous metal housing. Air from individual blowers cools both tubes and parts. Air intake for the transmitter is filtered by the replaceable filters in the lower portion of both cabinets.

The visual portion of the new BT-5C includes the exciter, IPA, 500 watt modulated amplifier, 5 Kw power amplifier, driver control unit, power amplifier control unit, regulated screen supply for the driver, regulated bias supply for the power amplifier, modulated, modulator power supplies, monochrome equalizer and 4.75 video cutoff filter, driver power supply and screen power supply for the power amplifier.

Among the latest technical advancements incorporated in the video modulator is sync-tip keyed clamping. Used to

avoid disturbing color signal components, sync-tip clamping means no "back-porch" disturbances of the color synchronizing burst. Built-in and operating from the com-



posit signal input, the keyed clamp generator uses a delay-line controlled keying pulse for maximum stability. Fail-safe protection circuits are provided which reduce power to mid-gray level in event of clamp or signal failure.

A white peak clipper is provided to considerably reduce the possibility of sync-buzz due to accidental over modu-

## BT-5C 5000 WATT VHF TELEVISION TRANSMITTER

lation of white portion of picture that extends beyond the 10% point of carrier transmission. A white stretcher circuit improves differential gain. In-built feedback restoration is provided to remove hum and/or tilt, thus minimizing the need for a stabilizing amplifier. Visual input coaxial cable terminations are adjustable and time proven tubes are used in modulator and power supply. The visual oscillator is designed to control the visual carrier frequency of the transmitter of both low and high band TV channels. Output is multiplied 3 times for the low and 9 times for high band channels. Plate voltage to the oscillator is closely regulated for stability. Under normal operating conditions, the oscillator will hold carrier frequency to within 300 cycles. Since the aural carrier itself is held within 300 cycles, FCC requirements are exceeded in the transmission of both color and monochrome. Construction and circuitry is straight forward and direct, with exciter, oscillator and power supply contained in one panel. Crystal is in a thermostatically controlled oven. The visual transmitter consists of the oscillator/exciter, two intermediate stages and the push-pull 6076 power amplifier for 5000 watts peak. Tuning adjustments are all from the front. Two power supplies provide voltage to the IPA stages (full wave 866A) and 5000 volts to the PA stage (six type 8008 in a 3 phase full wave circuit).

Twenty-one meters in the entire transmitter indicate all necessary circuits either direct or by multi-metering.

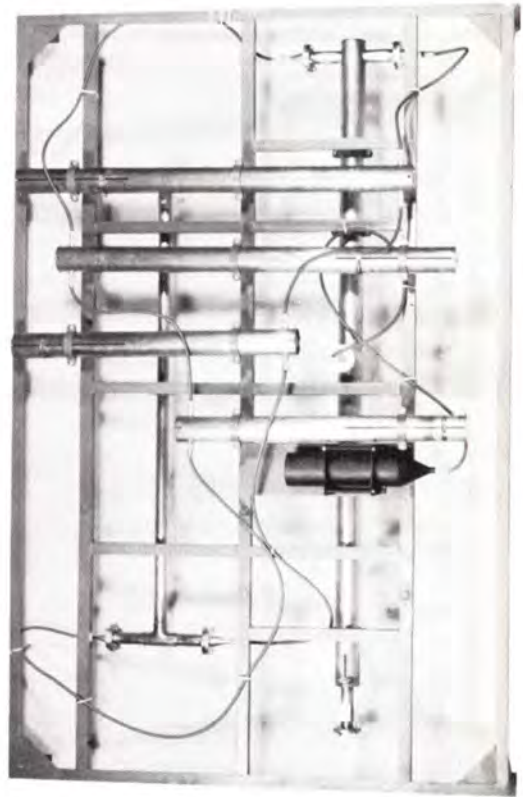

The vestigial sideband filter, illustrated above, is employed at the transmitter output prior to the transmission line and is standard equipment with all models.

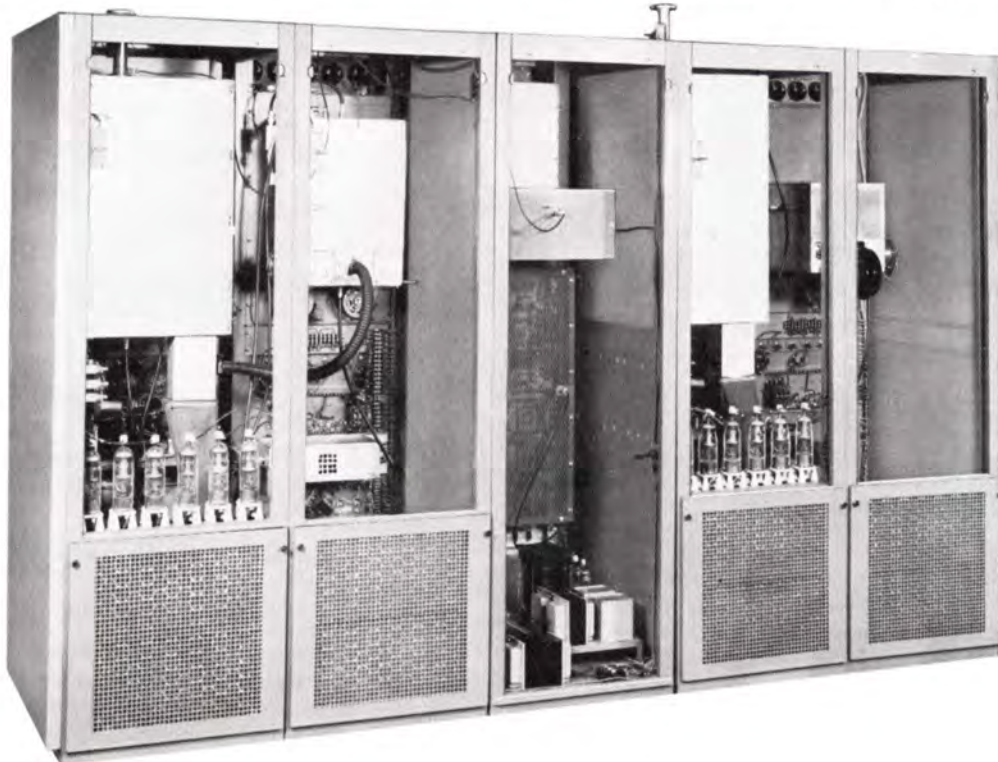



**BT-5C 5000 WATT VHF TELEVISION TRANSMITTER**

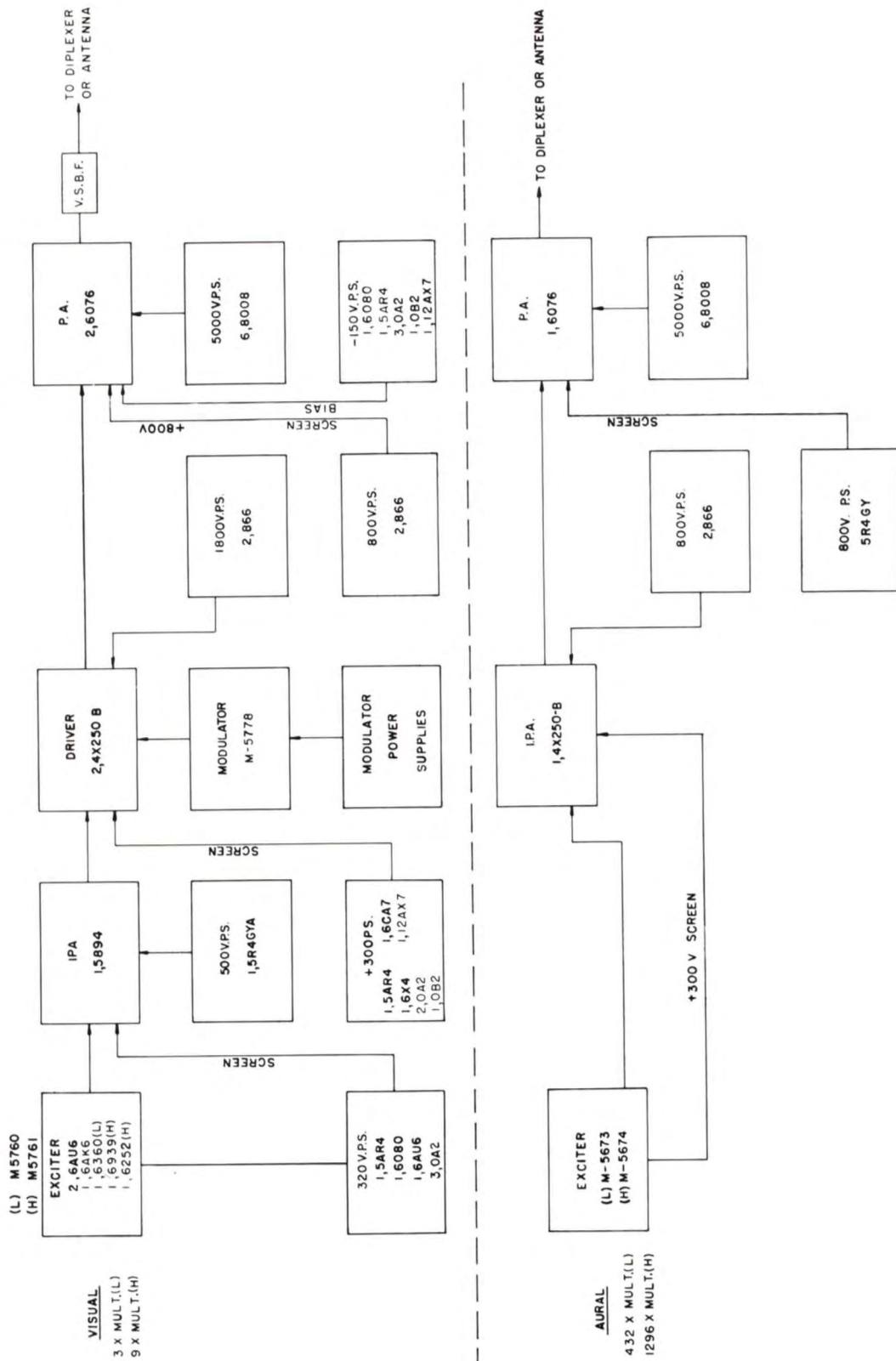

(L) CHAN. 2-6 BT5CL  
(H) CHAN. 7-13 BT5CH

BLOCK DIAGRAM FOR BT-5C  
5 KW TV TRANSMITTER  
GATES RADIO COMPANY  
QUINCY, ILLINOIS

## BT-5C 5000 WATT VHF TELEVISION TRANSMITTER

### SPECIFICATIONS

**POWER INPUT:** 230 volts, 50/60 cycles, three phase.  
Power consumption, approximately 28-KVA.

**POWER OUTPUT:**

Channels 2 thru 6 : Visual 5000 watts  
Aural 2500 watts

Channels 7 thru 13: Visual 4000 watts  
Aural 2000 watts

(generous excess to rated power is available for sideband filter and system losses).

**RF OUTPUT IMPEDANCE:** 50.0 ohms, 1-5/8 RETMA Flange.

**INPUT IMPEDANCE:** Video signal — 75 ohms, unbalanced. Audio signal — 600 ohms, balanced.

**FREQUENCY RESPONSE:**

Visual +2 to -2 db at 0.5 mcs.

Visual +2 to -2 db at 1.25 mcs.

Visual +2 to -2 db at 2.0 mcs.

Visual +2 to -2 db at 3.58 mcs.

The amplitude response will not vary more than +1 db to -2 db from the 3.58 mcs. response between 2.1 mcs. and 4.18 mcs. The amplitude at 4.75 mcs. is attenuated 20 db and frequencies higher than 4.75 mcs. are attenuated 20 db or greater.

Lower sideband response is

Visual -20 db at 1.25 mcs, and

-42 db at 3.58 mcs.

Aural Within 1.0 db of standard 75 microsecond preemphasis curve, 50-15,000 cycles.

**FREQUENCY STABILITY:** Visual ±500 cycles.

Aural ±500 cycles.

**MODULATION CAPABILITIES:**

Visual to 12 1/2% +2 1/2% of sync level. Aural ±40 Kc.

**INPUT LEVEL:** Visual 1.0 V. ±0.4 V. peak to peak.

Aural ±10 dbm ±2 db for 100% modulation.

**NOISE:** Aural 60 db below 100% modulation (FM).

50 db below equivalent 100% modulation (AM).

Visual 40 db below 100% AM modulation

**AUDIO FREQUENCY DISTORTION:**

50-100 cycles, 1.5% max.

100-10,000 cycles, 1% max.

10,000-15,000 cycles, 1.5% max. (at 25 Kc Swing).

**AMPLITUDE VARIATION:** 5% or less of peak sync. (one field).

**SUBCARRIER PHASE vs BRIGHTNESS:**

±7° maximum.

**LINEARITY:** ±15% maximum.

The power output for channels 7-13 has purposely been derated for conservative operation. Channels 7 through 10 may be operated at greater than 4 KW visual power with proportionate reduction in operating efficiency.

**ENVELOPE DELAY TOLERANCE:**

(From FCC Specified Curve).

±0.08 microseconds from 0.2-2.1 mc.

±0.04 microseconds at 3.58 mcs.

±0.08 microseconds at 4.18 mcs.

**HARMONIC ATTENUATION:** 60 db or better.

**REGULATION OF OUTPUT:** 7% from black to all white.

**INPUT POLARITY:** Black negative.

**TYPE OF MODULATION:** Phase shift employing pulse techniques.

**TYPE OF OSCILLATOR:** Direct crystal controlled (both aural and visual).

**TUBES:**

Visual	Aural
3 - 6AU6	1 - 12AT7
1 - 6AK6	7 - 6AU6
6 - GZ34/5AR4	3 - 12AX7
5 - 6080	3 - 6J6
11 - OA2	2 - OA2
9 - 12AT7	1 - 6360
2 - 6CL6	1 - 6AQ5
7 - 6CA7	1 - 6080
3 - 5651	1 - GZ34/5AR4
5 - OB2	1 - 4X250B
3 - 6AU8	1 - 6076
5 - 12AX7	2 - 866
1 - 6X4	6 - 8008
1 - 5894	1 - 6360
2 - 4X250B	3 - 12BH7
2 - 6076	1 - 6CS6
4 - 866	
6 - 8008	
1 - 5R4	

**TOTAL NUMBER TUBES:** Visual 82. Aural 30.

**TOTAL TUBE TYPES:** 24

**SIZE (OVER-ALL):** Width 96" (less end bells).

**SIZE (OVER-ALL):** Width 99" (with end bells).

**SIZE (OVER-ALL):** Height 78", Depth 36 1/2".

**WEIGHT:** Packed 3000 lbs. Net 2500 lbs.

**CUBAGE:** 136 cu. ft. unpacked.

**SIDEBAND FILTER:** Mounted external to cabinet

**COOLING:** Forced air

### ORDERING INFORMATION

Transmitter for channels 2-6, 5000 watts .....	BT-5CL
Transmitter for channels 7-13, 4000 watts .....	BT-5CH
Spare 100% tube complement for BT-5CL .....	TK-341
Spare 100% tube complement for BT-5CH .....	TK-343
<b>FCC Tube Complement</b>	
BT-5CL .....	TK-342
BT-5CH .....	TK-344
Color video filter (with power supply) .....	M-5892

# 500 WATT VHF TELEVISION TRANSMITTER

Model BT-500C

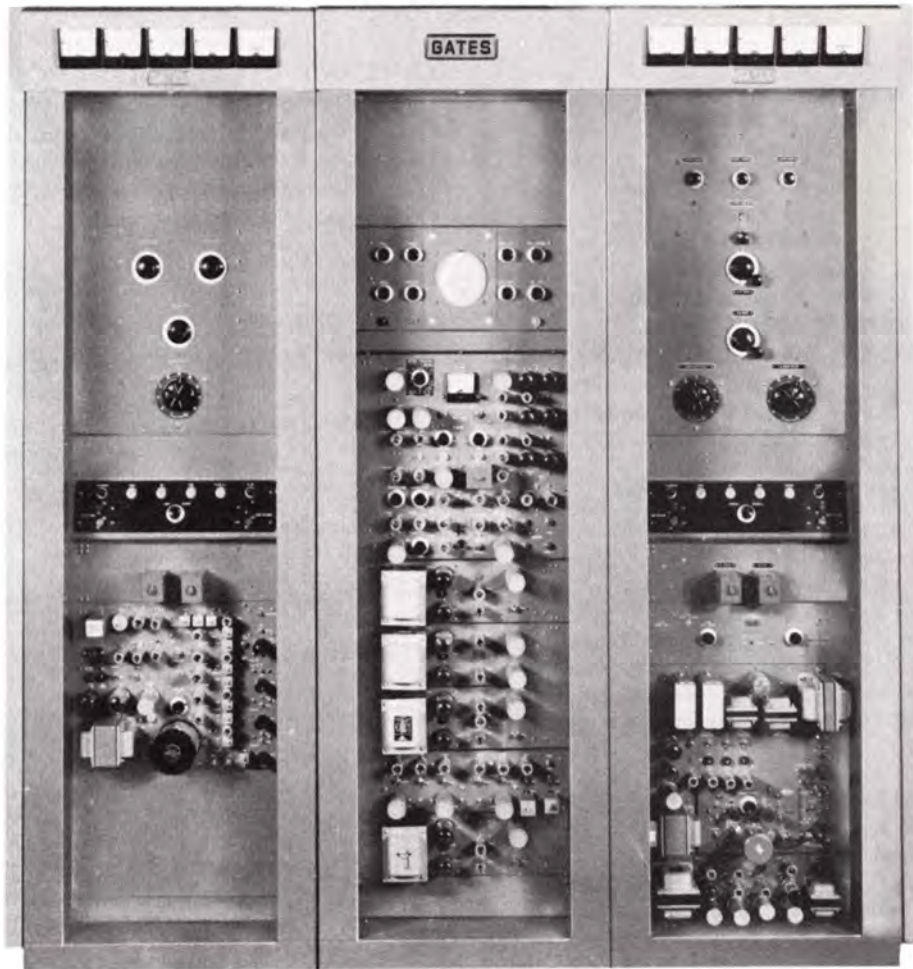

Model BT-500CL Channels 2-6

Model BT-500CH Channels 7-13

The all new BT-500C 500 watt television transmitter is an outstanding expression of the latest achievements in television transmission. With a newly improved video modulator, sync-tip keyed clamping, white peak clipper, and a white stretcher circuit to improve differential gain, the most exacting color and monochrome transmission is possible.

The BT-500C is completely self-contained in three cubicles — the left cubicle being the aural section and the remaining two the visual. Cubicles can be mounted either separately or together as one complete unit. There are separate high voltage power supplies for the aural and visual sections. Type 4X250B tetrodes are employed in the final amplifiers of the aural and visual sections. The video modulator is equipped with bias-failure alarm lamp, test meters, and numerous front panel test jacks. Keyer clamping and automatic switch-over to AC coupling are used

in the video modulator in case of program or sync failure. Visual transmitter is grid-bias modulated in the 500 watt visual amplifier by a dynamic cathode load modulator circuit. Rated power output is 500 watts peak visual with excess power available for losses in the system. The BT-500C can be enlarged to 5000 watts at anytime since it is actually a portion of the BT-5C 5000 watt TV transmitter.

The aural section is FCC rated at 250 watts, but is also capable of excess power for losses. On most channels, operating characteristics generously exceed many FCC maximum requirements. The exciter employs a phase shift modulator with pulse timing techniques delivering approximately 4 watts. This drives a single power amplifier stage. Two power supplies are incorporated in the aural section: (1) low voltage, (2) 1500 volt high voltage. When added to a conservatively rated tube comple-

## BT-500C 500 WATT VHF TELEVISION TRANSMITTER

ment and rigid construction, trouble-free performance is expected. Lack of frequency multiplication after the exciter unit is another important feature of the aural transmitter. This aids in eliminating spurious frequencies and gives protection to tube life as power type tubes doubling or tripling in frequency are not always operated under their most stable and life lengthening conditions.

The 250 watt power amplifier, both tubes and components, is totally enclosed in a non-ferrous metal housing with air from individual blowers cooling both tubes and parts. Air intake for the transmitter is filtered by the replaceable filters in the lower portion of both cabinets.

The visual portion of the new BT-500C includes the oscillator, exciter, IPA, 500 watt modulated amplifier, power amplifier control unit, regulated screen supply for the PA, regulated bias supply for the power amplifier, modulator, modulator power supplies, monochrome equalizer and 4.75 video cutoff filter.

Among the latest technical advancements incorporated in the video modulator is sync-tip keyed clamping. Used to avoid disturbing color signal components, sync-tip clamping means no "back-porch" disturbances of the color synchronizing burst. Built-in and operating from the composite signal input, the keyed clamp generator uses a delay-line controlled keying pulse for maximum stability. Fail-safe protection circuits are provided which reduce power to mid-gray level in event of clamp or signal failure.

A white peak clipper is provided to considerably reduce the possibility of sync-buzz due to accidental over modulation of white portion of picture that extends beyond the 10% point of carrier transmission. A white stretch circuit improves differential gain. In-built feedback restoration is provided to remove hum and/or tilt, thus minimizing the need for a stabilizing amplifier. Visual input coaxial cable terminations are adjustable and time proven tubes are used in modulator and power supply. The visual oscillator is designed to control the visual carrier frequency of the transmitter of both low and high band TV channels. Output is multiplied 3 times for the low and 9 times for high band channels. Plate voltage to the oscillator is closely regulated for stability. Under normal operating

conditions, the oscillator will hold carrier frequency to within 300 cycles. Since the aural carrier itself is held within 300 cycles, FCC requirements are exceeded in the transmission of both color and monochrome. Construction and circuitry is direct, with exciter, oscillator and power supply contained in one panel. Crystal is in a thermostatically controlled oven. The visual transmitter consists of the oscillator/exciter, one intermediate stage and the push-pull 4X250B power amplifier for 500 watts peak. Tuning adjustments are all from the front. Eleven meters in the entire transmitter indicate all necessary circuits either direct or by multi-metering. Latch-on type back doors are used. All incoming air is filtered and filter removes quickly for cleaning. Finish is two-tone gloss gray with chrome trim and black escutcheons.

The Gates BT-500C should be ordered with the optional M-5892 color video filter for color transmission. The filter replaces a blank panel space in the monochrome transmitter.

With the BT-500C, you can have complete confidence that your television transmission will be pleasing to your viewers.

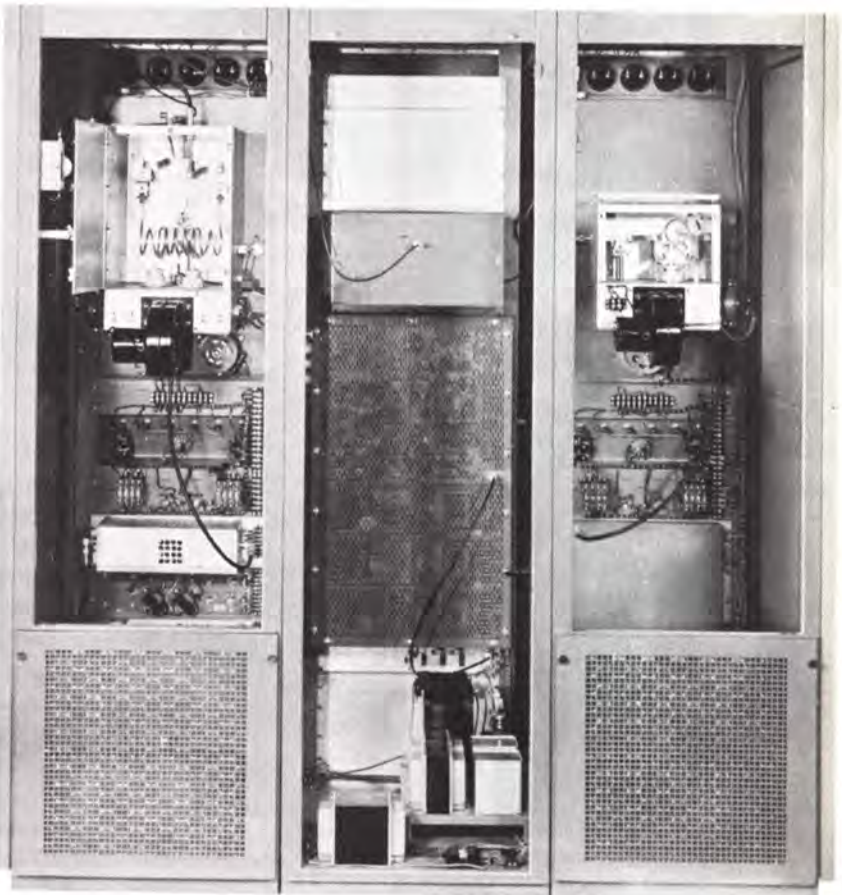

**BT-500C 500 WATT VHF TELEVISION TRANSMITTER**

**SPECIFICATIONS**

**POWER INPUT:** 230 volts, 50/60 cycles, single phase. (120 volts for crystal heaters). Power consumption, 4.5 KVA.

**POWER OUTPUT:** Visual 500 watts peak. Aural 250 watts. (excess to rated power is available for sideband filter and system losses).

**RF OUTPUT IMPEDANCE:** 50.0 ohms, type N female.

**INPUT IMPEDANCE:** Video signal — 75 ohms, unbalanced.  
Audio signal — 600 ohms, balanced.

**FREQUENCY RESPONSE:**

Visual — +2 to -2 db at 0.5 mcs.  
+2 to -2 db at 1.25 mcs.  
+2 to -2 db at 2.0 mcs.  
+2 to -2 db at 3.58 mcs.

(The amplitude response will not vary more than +1 db to -2 db from the 3.58 mcs. response between 2.1 mcs. and 4.18 mcs. The amplitude at 4.75 mcs. is attenuated 20 db and frequencies higher than 4.75 mcs. are attenuated 20 db or greater.)

Lower sideband response is;

-20 db at 1.25 mcs. and  
-42 db at 3.58 mcs.

Aural — Within 1.0 db of standard 75 microsecond pre-emphasis curve, 50-15,000 cycles.

**FREQUENCY STABILITY:** Visual ±500 cycles.  
Aural ±500 cycles.

**MODULATION CAPABILITIES:** Visual to 12½% ±2½% of sync level. Aural ±40 Kc.

**INPUT LEVEL:** Visual 1.0 V ±0.4 V. peak to peak. Aural ±10 dbm ±2 db for 100% modulation.

**NOISE:** Aural 60 db below 100% modulation (FM). 50 db below equivalent 100% modulation (AM). Visual approximately 45 db below 100% AM modulation.

**AUDIO FREQUENCY DISTORTION:**

50-100 cycles, 1.5% max.  
100-10,000 cycles, 1% max.  
10,000-15,000 cycles, 1.5% max. (at 25 Kc Swing).

**AMPLITUDE VARIATION:** 5% or less of peak sync. (one field)

**SUBCARRIER PHASE vs BRIGHTNESS:** ±7° maximum.

**LINEARITY:** ±15% maximum.

**ENVELOPE DELAY TOLERANCE:**

(From FCC Specified Curve).  
±0.08 microseconds from 0.2-2.1 mc.  
±0.04 microseconds at 3.58 mcs.  
±0.08 microseconds at 4.18 mcs.

**HARMONIC ATTENUATION:** 60 db or better.

**REGULATION OF OUTPUT:** 7% from black to all white.

**INPUT POLARITY:** Black negative.

**TYPE OF MODULATION:** Phase shift employing pulse techniques. (Aural)

**TYPE OF OSCILLATOR:** Direct crystal controlled (both aural and visual).

**TUBES:** Visual — (3) 6AU6, (1) 6AK6, (4) 6080, (8) OA2, (9) 12AT7, (2) 6CL6, (7) 6CA7, (3) 5651, (4) OB2, (3) 6AU8, (1) 6CS6, (3) 12BH7, (4) 12AX7, (1) 6X4, (1) 5894, (2) 4X250B, (2) 866, (5) 5AR4, (1) 5R4, (1) 6360L.

Aural — (1) 12AT7, (7) 6AU6, (3) 12AX7, (3) 6J6L, (2) OA2, (1) 6360L, (1) 6AQ5, (1) 6080, (1) 4X250B, (2) 866, (1) 5AR4.

**TOTAL NUMBER TUBES:** Visual 65. Aural 23.

**TOTAL TUBE TYPES:** 22.

**SIZE (OVER-ALL).** Width 72" (less end bells).  
Width 75" (with end bells).  
Height 78", Depth 36½".

**WEIGHT:** Packed 2000 lbs. Net 1500 lbs.

**CUBAGE:** 117 cu. ft. unpacked.

**SIDEBAND FILTER:** Mounted external to cabinet.

**COOLING:** Forced air.

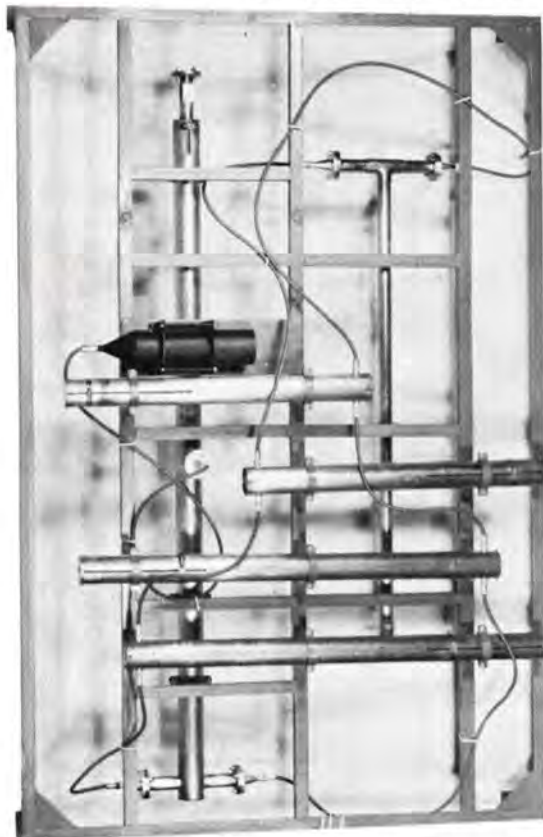

The vestigial sideband filter, illustrated above, is employed at the transmitter output prior to the transmission line and is standard equipment with all models.

**ORDERING INFORMATION**

**Model M-5901 broadcast television transmitter, 500 watts, with tubes, one crystal and oven for channels 2-6** ..... BT-500CL

**Model M-5902 broadcast television transmitter, 500 watts, with tubes, one crystal and oven for channels 7-13** ..... BT-500CH

**Spare 100% tube complement for BT-500CL** ..TK-357

**Spare 100% tube complement for BT-500CH** TK-358

**FCC tube complement (required FCC spares)**

**BT-500CL** .....TK-365

**BT-500CH** .....TK-366

**Color video filter (with power supply)** ..... M-5892

# 100 WATT TV TRANSMITTER

Model BT-100A

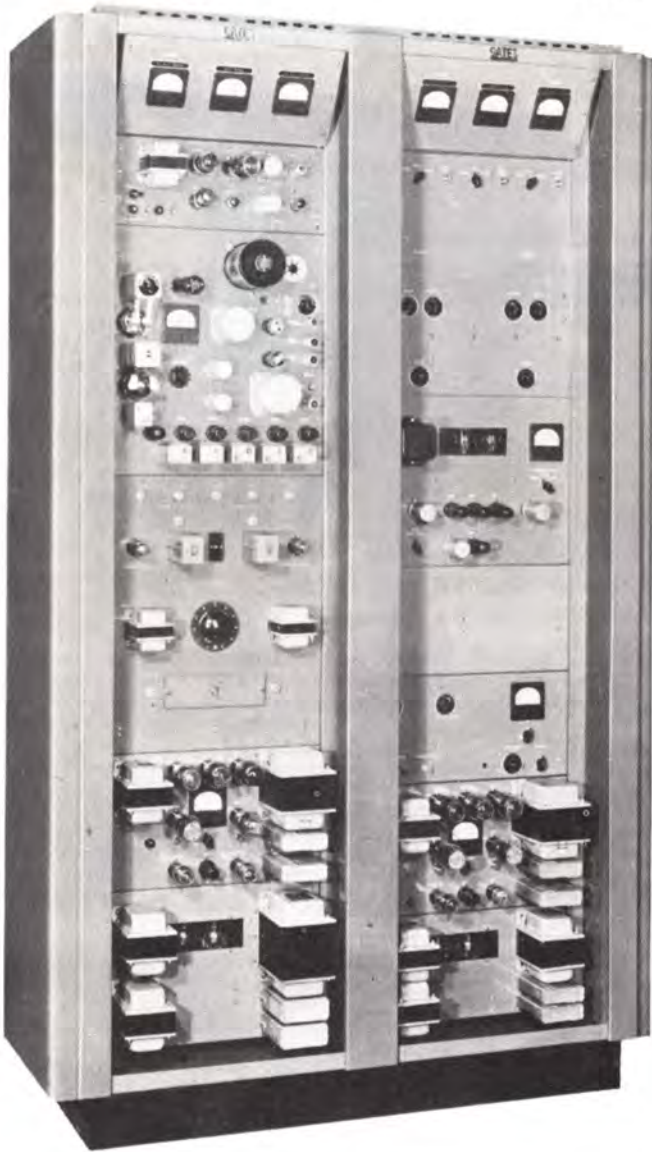

Low power television or satellite operation is becoming more and more popular. For VHF channels 2-13, the BT-100A excellently fills this need in providing both picture sharpness and aural quality second to none. The BT-100A transmitter is built in two standard rack cabinets. Use of vertical construction assures 100% access to all parts. Top quality characteristics of Gates equipment is certainly amplified in the BT-100A transmitter by fine workmanship and the use of the best components money can buy. A 50 watt model, identical to the BT-100A in appearance, is also available with 50 watt video and 30 watt aural output.

The Gates BT-100A television transmitter is a complete aural-visual equipment ready to attach to aural and video input and antenna. Though the maximum power rating is 100/60 watts for visual-aural, the BT-100A may be operated at lower powers also. Ideal as a low power TV transmitter, it may be employed as an exciter for higher powered transmitters and will find good acceptance for production line testing of TV receivers as well as laboratory use.

The aural section of the transmitter consists of an exciter modulator and a power amplifier. Referring to the block diagram on the next page, the oscillator is crystal controlled with the output coupled to the shaping and modulating circuits. Audio voltage is applied in such a manner to cause a phase shift in the oscillator frequency of the audio rate. The oscillator frequency is then multiplied through a series of multipliers to the operating frequency. The output of the exciter modulator is at operating frequency and is used to drive the power amplifier. Conventional circuitry is used throughout.

Visual section design consists of an RF exciter, video modulator, and power amplifier. The exciter multiplies the crystal oscillator frequency to the operating frequency and at the proper power level to drive the power amplifier. The modulator is a video amplifier that amplifies a standard video input voltage to the power required to modulate the power amplifier. The power amplifier is grid-bias modulated. A diode is used to restore the DC component at the grid of the modulating stage. The modulating stage is DC coupled to the grid of the power amplifier.

A direct reading power output and VSWR indicator is standard equipment. Also provided is a video demodulator wave form and modulation monitor, indicating modulation percentage and wave shape. The monitor output may be attached to a wave form or picture monitor.

Vertical construction is employed for ease in servicing. Cabinets are finished in hand rubbed gloss gray and provided with full length rear doors.

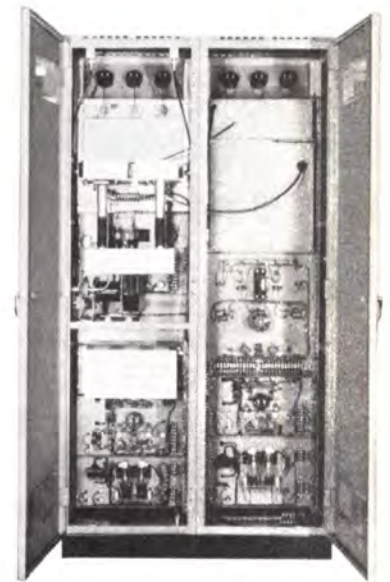

Rear BT-100A view. Left cabinet contains visual and aural power amplifiers, visual exciter, modulator and power supplies. Right cabinet, demodulator, aural exciter, control and protective panel and power supplies.

## MODEL BT-100A 100 WATT TV TRANSMITTER SPECIFICATIONS

POWER INPUT: 117 volts, 50/60 cycles, 1700 watts.  
 POWER OUTPUT: Visual 100 watts, aural 60 watts.  
 RF OUTPUT IMPEDANCE: Visual 50 ohms, aural 50 ohms.  
 INPUT IMPEDANCE: Visual 75 ohms, aural 600 ohms.  
 FREQUENCY RESPONSE: Visual  $\pm 2$  db at 500 Kc.  $\pm 2$  db at 1.5 Mc.  $\pm 2$  db at 2 Mc.  $\pm 2$  db at 3 Mc.  $\pm 3$  db at 4 Mc.  
     Aural  $\pm 1\frac{1}{2}$  db, 50-15,000 cycles (Reff. 75 micro-sec. pre-emphasis curve or flat).  
 CARRIER STABILITY: Visual  $\pm 500$  cycles, aural  $\pm 500$  cycles.  
 MODULATION CAPABILITY: Visual 85%, aural  $\pm 40$  Kc.  
 INPUT LEVEL: Visual 1.4 VPP, aural  $\pm 10$  dbm.  
 NOISE: Visual 40 db below peak carrier,  
     Aural FM 55 db below 100% mod., AM 50 db below 100% mod.  
 DISTORTION: Aural  $1\frac{1}{2}\%$  or less 50-15,000 cycles.  
 AMPLITUDE VARIATION: 7% or less of peak sync (one field).  
 LINEARITY:  $\pm 20\%$  max.  
 HARMONIC ATTENUATION: 60 db or better.

BT-100AL(2-6) Tube Complement: (5) OA2, (2) OC3, (2) 5AR4, (2) 5U46, (1) 5V4, (10) 6AU6, (1) 6AR6 (4) 6AS76, (1) 6AQ5, (1) 6AH6, (1) 6AL5, (4) 6A67, (3) 6CD6, (1) 6CL6, (1) 6SH7, (3) 6J6, (1) 6X5, (1) 12AT7, (4) 12AX7, (2) 6080, (2) 6360, (2) 866, (2) 4X15A.

TOTAL TUBES: 56.  
 TOTAL TUBE TYPES: 23.

BT-100AH(7-13) Tube Complement: (5) OA2, (2) OC3, (2) 5AR4, (2) 5U46, (1) 5V4, (10) 6AU6, (3) 6AK6, (4) 6AS76, (1) 6AQ5, (1) 6AH6, (1) 6AL5, (4) 6A67, (3) 6CD6, (1) 6CL6, (1) 6SH7, (1) 6X5, (1) 12AT7, (4) 12AX7, (2) 6080, (2) 6252, (2) 6939, (2) 4X150A, (2) 866.

TOTAL TUBES: 57.  
 TOTAL TUBE TYPES: 23.  
 SIZE: 50" wide, 84" high, 21" deep.  
 WEIGHT: 1400 lbs. approximately.  
 CUBAGE: 68 cu. ft.

### ORDERING INFORMATION

Model BT-100AL transmitter for channels 2-6 ..... M-5364A  
 Model BT-100AH transmitter for channels 7-13 ..... M-5113A  
 Spare 100% tube complement for BT-100AL ..... TK-289  
 Spare 100% tube complement for BT-100AH ..... TK-354  
 FCC tube complement (required FCC spares) BT-100AL ..... TK-372  
 FCC tube complement (required FCC spares) BT-100AH ..... TK-370

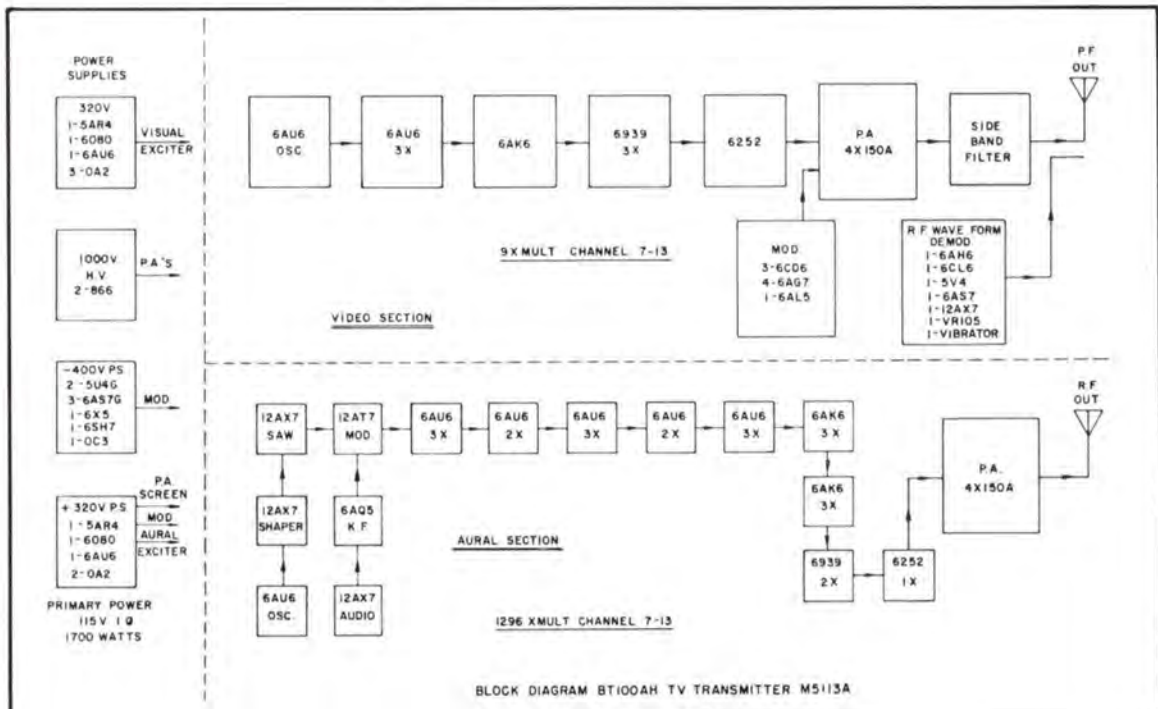

# DAGE PROFESSIONAL VIDICON CAMERA

Models 320-B/V & 320-B/F

## 700 LINE RESOLUTION BROADCAST

## SPECIFICATIONS



The Model 320-B/V Studio Broadcast Camera has been designed from years of experience in vidicon camera engineering. The result is a precision television camera, production built to work long hours without maintenance.

Complete accessibility to all components and multiple check points are standard equipment with the Model 320-B series of cameras. Fold out sides and fold down chassis provide for instantaneous adjustment by operating personnel for optimum performance. Complete removal of individual chassis for bench service can be accomplished by removing several screws from the hinge and unplugging the taper pins. No soldering iron or wrenches are required.

A four-lens, rear-controlled, turret is also supplied as standard equipment on the Model 320-B series of cameras. Adaptability to provide rear control of a zoom lens is also offered as optional equipment. Built in circuitry for two-way intercom and tally lights is provided, making this camera the ideal unit for every studio or remote function.

The 5" electronic viewfinder is a completely separate unit which can be removed from the camera head with no change in performance of the camera itself. The camera can then be used as a film camera or for other non-viewfinder applications.



**MODEL 320-B/F**

The Model 320-B/F camera is identical to the Model 320-B/V with exception that the electronic viewfinder has been removed and replaced by a dust cover-blower assembly. The camera can now be used as a film camera or for any other non-viewfinder application, such as on a remote servo pan and tilt.

### ELECTRICAL:

Input From Camera Control	
Scanning .....	EIA or CCIR standards
Vertical Drive .....	4 volts p-p 50 cps for 625 line scanning 60 cps for 525 line scanning
Horizontal Drive .....	4 volts p-p 15,625 cps for 625 line, 50 field scanning. 15,750 cps for 525 line, 60 field scanning.
Power	
Camera .....	105-125V AC 60 cps 35 watts for filaments 280V DC @ 150 milliamperes
Viewfinder .....	105-125V AC 60 cps 20 watts for filaments 280 V DC @ 160 milliamperes
Output From Camera	
Video Response .....	Flat within $\pm 0.5$ db to 8 mc and within 3 db to 10 mc measured without aperture correction.
Resolution .....	700 TV lines horizontal resolution at center of picture and over 525 TV lines resolution at corner circles.
Picture Signal .....	0.03 volts p-p (Black Negative Polarity).
Aperture Correction .....	20 db of correction variable over a range of 6 db.
Impedance .....	51.5 ohms.
Cable Length .....	Up to 1000' maximum.

### OPTICAL:

Light Requirement .....	100-150 foot candles incident illumination for quality noise free picture with f/1.5 lens.
Spectral Response .....	Approximately the same as the human eye (7325/7038 vidicon).
Lenses .....	16mm "C" mount, Turret provisions for 4 lenses. Special mount for rear controlled zoom lens available.
Viewfinder .....	5" Electronic (5AYP4 Tube) utilizing magnetic deflection and electrostatic focus. Safety glass provided for operator protection.

### MECHANICAL:

Finish .....	Blue and silver lustre baked enamel.
Weight .....	30 lbs. (with viewfinder)
Mounting .....	1/4" 20 tapped for standard tripod screw.

### PHYSICAL DIMENSIONS:

Height .....	12"
Weight .....	7 3/4"
Length .....	18 1/2"

## ORDERING INFORMATION

Live Camera; including 320-B Camera Head with rear controlled 4 lens turret, side focus, A-1490 Viewfinder with hood and 50 ft. of camera cable .....	320-BV
Film Camera; including 320-B Camera Head with rear controlled 4 lens turret, side focus, A-2580 Top Assembly (replacement for Viewfinder) and 50 ft. camera cable .....	320-BF



## DAGE EPS-21 TELEVISION SYSTEM



The EPS-21 Professional Television System consists of equal numbers of cameras and control consoles (Model 725-A), plus one Master monitor console (Model 636-A). Any number of Dage 320-B Series cameras and controls can be added to the studio system with switcher-fader capacity for six cameras. Two switcher-fader units could be placed in series to feed a total of eleven cameras.

Packaged in attractive Emcore "Low-Boy" Cabinets, the EPS-21 presents an appealing studio appearance while providing top quality broadcast performance. The console equipment can also be placed in standard 19" vertical racks should you so desire. Its ease of operation coupled with the economy of original purchase makes the EPS-21 System an asset to any television studio.

- **FLEXIBILITY**—A simple system can be expanded with additional camera chain units with no complicated installation.
- **VERSATILITY**—Can handle all studio situations while providing standard Broadcast Quality signal.
- **SIMPLICITY OF OPERATION**—The camera and console controls are in panel groupings easily mastered even by inexperienced operators.
- **EASE OF MAINTENANCE**—Monitors and camera controls are mounted on slide-out rails. Camera controls also pivot for complete accessibility.
- **ECONOMY**—Modular design accommodates increased capability by adding cameras and controls without obsolescence of present equipment.

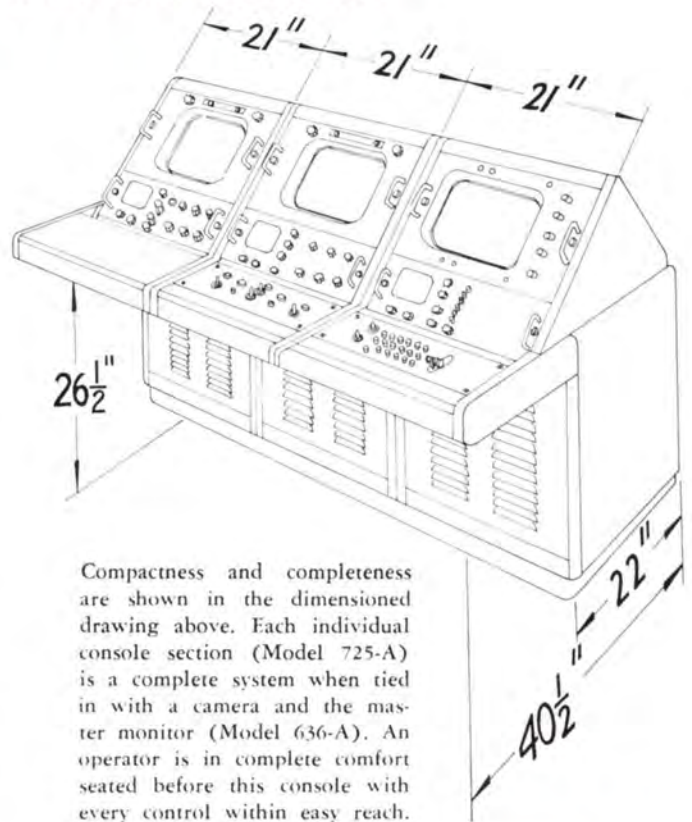

Compactness and completeness are shown in the dimensioned drawing above. Each individual console section (Model 725-A) is a complete system when tied in with a camera and the master monitor (Model 636-A). An operator is in complete comfort seated before this console with every control within easy reach.

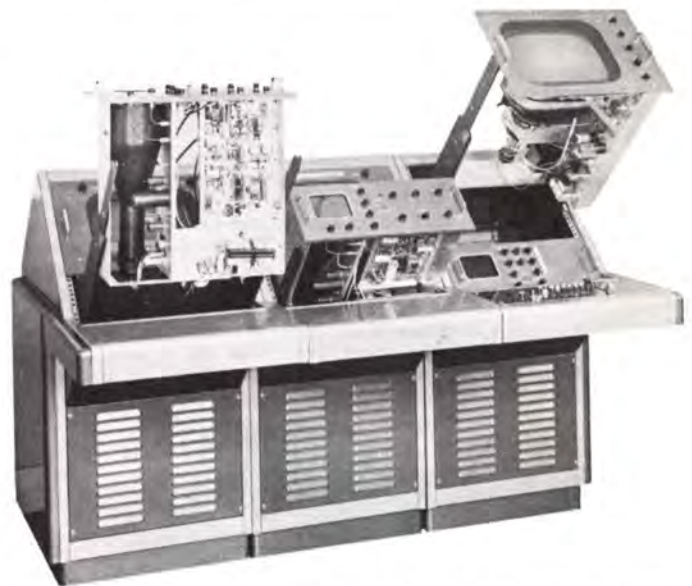

With all of its compactness, the EPS-21 System is the easiest equipment to service in the business. From the 320-B series of cameras with their fold-down sides and fold-out chassis, to the pull-out and tilt chassis in the consoles, every component can be reached without taking out screws and lifting down racks. The chassis in the console housings pull out on sliding rails, then lock in position for servicing. Should it be necessary to remove a unit for bench service, this is equally easy and requires only the depressing of two snap pins to completely remove any of the controls.

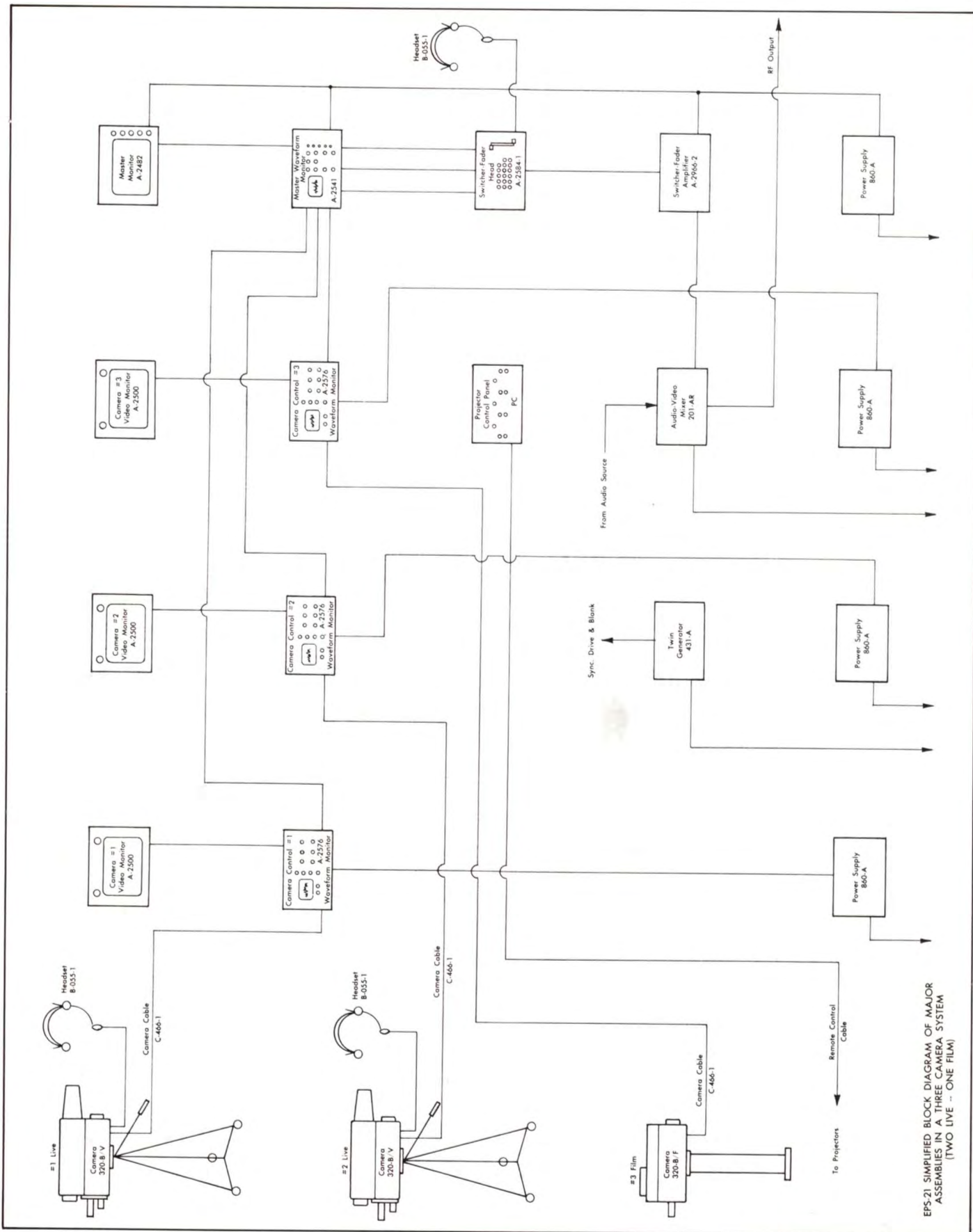

EPS-21 SIMPLIFIED BLOCK DIAGRAM OF MAJOR ASSEMBLIES IN A THREE CAMERA SYSTEM (TWO LIVE -- ONE FILM)

# EPS-21 TELEVISION SYSTEM ASSEMBLIES

A few of the various assemblies which make up the EPS-21 System are listed on this page. For detailed information on all major assemblies as shown in block diagram on previous page, write Gates for Bulletin E-29.

## MODEL C-466-1, CAMERA CABLE

This cable provides the flexible connection between camera and console for carrying picture signal and intercom conversation between camera and console operators. A variety of cable lengths are available.

## MODEL A-2482, MASTER MONITOR

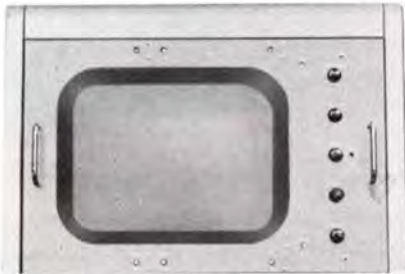

This broadcast monitor allows a constant check on the quality of the video picture being "aired" or placed on closed circuit. Pulse cross display for easy monitoring of sync standards is built into the monitor providing maximum efficiency of operation.

## MODEL A-2541, MASTER WAVEFORM MONITOR



The waveform monitor presents the same picture information as the line monitor except in a calibrated oscilloscope type display. This permits accurate analysis of picture characteristics being transmitted by the camera "on the line" plus selectable preview facilities.

## MODEL A-2500, VIDEO MONITOR



This monitor allows the console operator to view camera images at all times. A check is thus provided on camera focus and picture composition before selecting and switching the camera image for distribution. The monitor may also be used as a broadcast standard for the evaluation of picture quality.

## MODEL A-2576, CAMERA CONTROL AND WAVEFORM MONITOR ASSEMBLY



The camera control allows for adjustment of picture characteristics of each camera from the console position. A 5" calibrated waveform monitor is provided as an aid for picture adjustment and set up. Tally lights on the panel, controlled by the switcher-fader, indicate which camera is "on the air."

## MODEL PC, PROJECTOR CONTROL



Remotely located slide projector and motion picture projectors are controlled through this panel. Starting and stopping of all projectors is accomplished with tally lights indicating the running projector unit.

## MODEL A-2584-1, SWITCHER-FADER HEAD



This switcher-fader head and the Model A-2966-2 amplifier go together to form the Model 521-B Switcher-Fader Assembly. Instantaneous picture change, fading, superimposition and lap dissolve are all standard functions of this unit.

## MODEL A-2966-2, SWITCHER-FADER AMPLIFIER



As indicated above, this amplifier is an integral part of the Model 521-B Switcher-Fader Assembly. Without this unit, all functions except simple picture switching would be impossible.

# DAGE ETS-1 TELEVISION SYSTEM

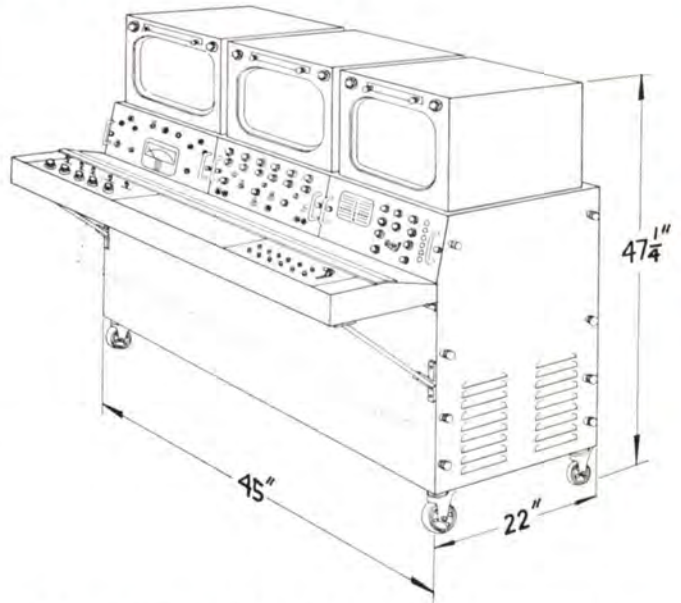

The ETS-1 is a professional broadcast-quality television system designed specifically for professional requirements. This system employs one, two or three Dage Model 320 series vidicon cameras. System components are attractively packaged in a mobile console. The ETS-1 is **RUGGED, COMPACT, EASY TO OPERATE, EASY TO MAINTAIN, FLEXIBLE AND VERSATILE.**

Compactness and mobility of the ETS-1 are shown in the drawing above. By assembling all equipments into the one console housing, a completely mobile, professional quality system is available to any studio, laboratory, lecture hall or classroom. With the operating table folded down, standard 30" doorways offer no problem to movement of the unit. Requiring only 34" x 45" of floor space, the ETS-1 is one of the most compact and complete Television Systems in existence.

- **FLEXIBILITY . . .** achieved through modular construction. Optional units can be selected to make the ETS-1 a "custom" installation engineered to meet your needs.
- **MOBILITY . . .** achieved by packaging system components in a console capable of passing through 30" doorways on free running wheels with the operating panel folded into the storage position.
- **VERSATILITY . . .** in pick up of live teaching situations in all subject areas, also slide and motion picture projection images, as well as magnification of microscopic or other small demonstration materials.
- **SIMPLICITY OF OPERATION . . .** The camera and console controls are in panel groupings easily mastered even by inexperienced operators.
- **EASE OF MAINTENANCE . . .** Major console assemblies are in pull-out or swing-out rack mountings for complete accessibility.
- **ECONOMY . . .** by modular design anticipating growth from a single camera chain to studio originating facilities by the addition of individual units rather than replacement of complete equipments.



Although extremely compact, the ETS-1 provides complete accessibility to all assemblies through **REMOVABLE PANELS . . . SWING-OUT MOUNTINGS . . . SLIDE-OUT RACKS . . . CONVENIENT TEST POINTS.** No special tools are required.

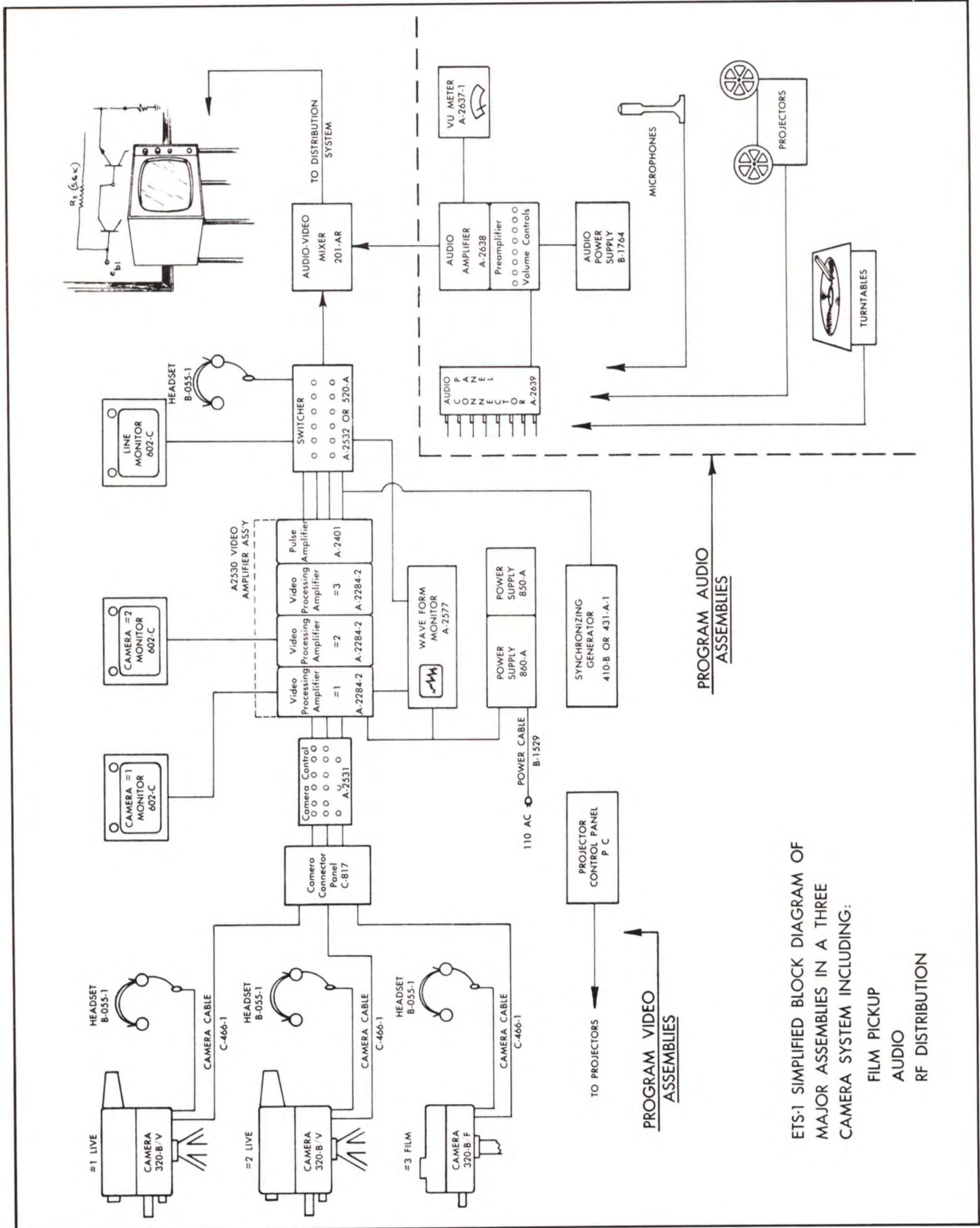

ETS-1 SIMPLIFIED BLOCK DIAGRAM OF MAJOR ASSEMBLIES IN A THREE CAMERA SYSTEM INCLUDING:

- FILM PICKUP
- AUDIO
- RF DISTRIBUTION

# ETS-1 TV SYSTEM ASSEMBLIES

A few of the various assemblies which make up the ETS-1 System are listed on this page. For detailed information on all major assemblies as shown in block diagram on previous page, write Gates for Bulletin E-14.

## MODEL A-2531, CAMERA CONTROL PANEL



The camera control panel allows for adjustment of picture characteristics of each camera from the console position, so that cameras can be matched for sensitivity, contrast and other functions. Tally lights on the panel indicate which camera is "on the air." Output jacks provide connection for the console operators' headset. Camera main power switches are also located on this panel.

## MODEL A-2530, VIDEO PROCESSING ASSEMBLY



Amplification of video signal received from the camera is accomplished by means of one Model A-2401 pulse amplifier and a separate Model A-2284-2 processing amplifier for each camera in the system, up to three. This is the video processing assembly. Through this unit adjustment of gray scale by gamma correction is also accomplished. By virtue of this gamma correction circuitry, the system can be matched for compatibility with other systems including image orthicon equipment.

## MODEL 602-C, VIDEO MONITORS



These monitors allow the console operator to view camera images at all times. A check is thus provided on camera focus and picture composition before selecting the chosen camera image to be sent to the classroom receivers.

## MODEL A-2532, SWITCHER



This switcher is the basic unit providing instantaneous picture change from one camera to another. No gradual transition of pictures or superimposition of pictures can be accomplished with this unit.

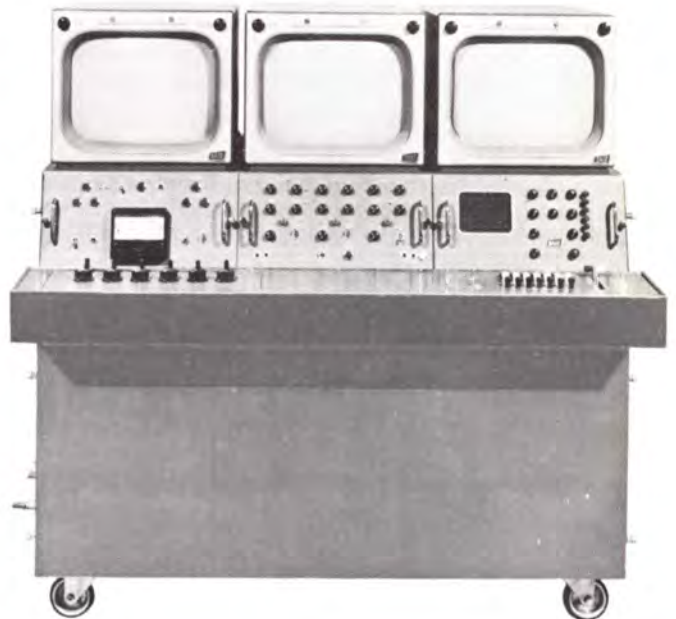

The ETS-1 system shown above is the complete deluxe system with full facilities for three cameras, projection control, audio intercom and RF distribution. A system can be designed for your specific needs embodying as many or as few of these features as you may desire.

The absolute minimum system which can be employed incorporates only one camera, one monitor serving both as a line monitor and a video monitor and contains no facility for audio, projection control, or intercommunication. This equipment contains all of the necessary space and fittings for expansion to a complete three camera system.

For complete information on the ETS-1 TV system, write Gates for Bulletin E-14.

# DAGE TWIN GENERATOR

Model 431-A/B



- Two independent, plug-in, transistorized synchronizing generators.
- Switchover between generators either manual (Model 431-A) or remotely controlled (Model 431-B).

The Dage Model 431-A/B Twin Generator is comprised of two independent transistorized synchronizing generators, mounted on a standard 19" rack panel together with a changeover switch. In the Model 431-A, this changeover switch is a manually operated rotary switch, while in the Model 431-B, the changeover is accomplished by a solenoid driven switch actuated by a selector on the front

- Each synchronizing generator comprised of plug-in modules for rapid replacement.
- Standard UHF type connectors on outputs.
- Extremely low power consumption.
- All modules guaranteed one full year. Module exchange service available after that time.
- Individual, transistorized, regulated power supplies, with silicon rectifiers.
- Outputs meet all EIA and FCC specifications for broadcast synchronizing generators.
- No complex operating adjustments required.

panel or at a remote location. Each generator is a separate plug-in unit containing its own regulated power supply. The outputs meet all EIA and FCC specifications.

(For further information, write Gates for Bulletin E-6)

DAGE Twin Generator ..... Model 431-A/B

# MODEL 334 MINIATURE TV CAMERA

- Complete transistorization, No Vacuum Tubes.
- Automatic, No Functional Controls Required.
- Self-contained, No External Circuits.
- Extreme Reduction in Size and Weight.
- High Quality "600" picture.
- Full EIA "Broadcast" Synchronization.
- Automatic Electronic Self-Adjustment to Light Level.
- Printed Circuits with Potted Plug-in Circuit Modules.
- Rugged, Non Microphonic, Ultra Reliable.

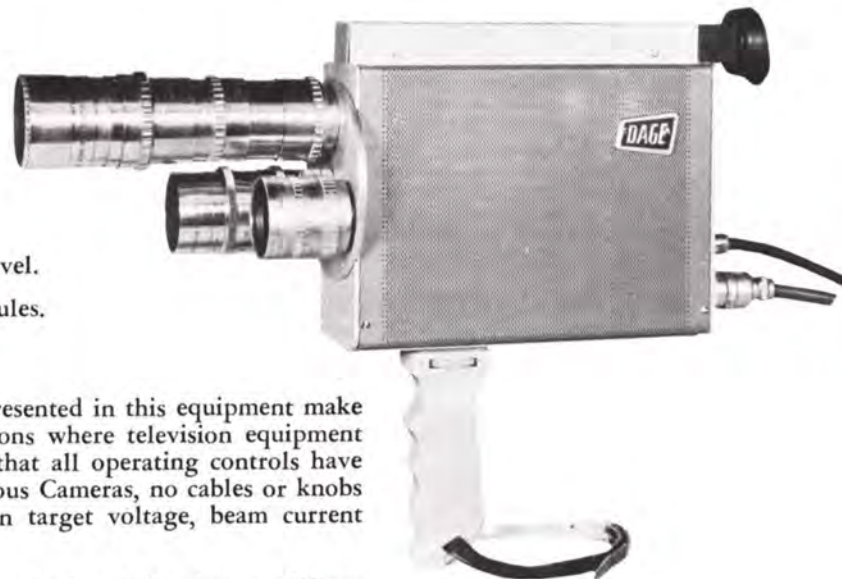

The tremendous savings in weight and volume represented in this equipment make it possible to employ television in difficult situations where television equipment was not previously feasible. Important is the fact that all operating controls have been removed from Model 334. Thus, unlike previous Cameras, no cables or knobs are required for operational adjustment of vidicon target voltage, beam current and electronic focus current.

The 334 Camera contains its own synchronizing generator, deflection amplifiers, power supply and video amplifiers in one compact unit and, therefore, operates without any need for complex power supplies and control units in adjacent areas.

DAGE miniature TV Camera ..... Model 334

# ACCESSORY EQUIPMENT

## TV TWIN SELECTROSLIDE JUNIOR



Holds 32 slides; 16 in each turret. Slide turrets are interchangeable and are keyed for accurate alignment. Accurate focusing is assured. Atmospheric condensing system assures perfect illumination. Two prisms and beam splitter prism are provided. Pictures may be superimposed, faded, or rapidly changed by switching or dimming projection lamps. 500 line resolution is guaranteed. Each projection can be operated independently of others by remote control or by push button. No vibration. Turret rotates by hand for checking of slides. Lamp capacity is 50 to 150 watts. Operates on 110-120 V, 60 cycle.

Lenses from 7½" to 11" are available — insure clear monochrome or color images. Please specify type of camera to be used with projector when ordering.

TV Twin Selectroslide Jr. w/o lens ..... 330A

TV Twin Selectroslide Jr. w/15 slide previewing feature ..... 330C

## SELECTROSLIDE JUNIOR



The TV Selectroslide Jr. holds 16 slides in its turret. Slide turrets are interchangeable and are keyed for accurate alignment. Four registering pins for each slide insure perfect focusing.

With the new aspheric condensing system, even light distribution over the entire picture area is assured.

The turret can be shifted by pressing a button situated on the side of the housing or a line cable can be connected to a terminal board inside the lower part of the housing for remote operation from the control panel. The slide mechanism is absolutely free from vibration. For quick checking and re-setting of slides, the turret can also be rotated by hand from one direction.

Well corrected, coated anastigmat lenses insure clear and well defined images for either monochrome or color, in the iconoscope or multiplexer. Lenses from 5" to 11" are available.

Lamp capacity 50 to 300 watts — 150 watts generally used. Diameter is 11" — Height: 10½" including base board. Wooden base board: 11½" x 12".

TV Selectroslide Jr. w/o lens ..... 322A

TV Selectroslide Jr. w/15 slide previewing feature w/o lens ..... 322C

Spare turret for 16 slides ..... 323

## LENSES FOR SELECTROSLIDES

- 5" lens in special TV focusing mount ..... 343
- 7" lens in special TV focusing mount ..... 344
- 7½" lens in special TV focusing mount ..... 344A
- 9" lens in special TV focusing mount ..... 345
- 11" lens in special TV focusing mount ..... 348

## MODEL 335ER VHF-UHF TV MONITOR



Model 335ER is the most compact and inexpensive quality TV monitor offered. Yet this versatile instrument performs every important TV carrier monitoring function continuously and without adjustment, and with the dependability and accuracy you expect from Hewlett-Packard. The instrument is equally useful in monochrome or color broadcasting; you can buy it now for black-and-white monitoring and later use the same low-cost monitor—without modification — when you convert to color.

In addition to continuous, precise indication of visual and aural frequency deviation and percentage of aural modulation, Model 335ER shows inter-carrier separation directly. No calculation is required.

Carefully engineered crystal reference oscillators provide accuracy in excess of F.C.C. requirements for all channels. Because discriminator accuracy does not depend on a tuned circuit, no time-consuming adjustments are required during operation. It is never necessary to reset carrier level or realign circuits. Proper operation of the monitor can be checked conveniently by controls located behind the hinged panel cover.

The three panel meters monitor visual and aural carrier frequency and percent modulation of the aural carrier with 100% modulation equal to 25 KC deviation. A peak modulation indicator lamp is included as standard equipment; the instrument also has provision for remote indicating meters, remote peak modulation indicating lamp, and a demodulated signal for measuring FM and AM noise levels, frequency response and distortion of the aural transmitter and for continuous program monitoring.

## CAMERA TRIPODS SPRING HEAD TRIPOD



This model ideal for vidicon cameras weighing up to 25 lbs. Constructed with spring load tilt which assures camera returning to neutral position when lever is in unlocked position. Range, 44½" low to 73" high. Built-in spirit level. Model B triangle is optional base unit to keep legs from spreading and marring floors.

- Professional Jr. spring head tripod ..... GR-973
- Model B triangle ..... GR-974

## BELL AND HOWELL TV PROJECTOR

BELL & HOWELL "614 JAN" is a TV projector for 16 mm designed for use with vidicon film chains and having an important exclusive feature of being able to play back magnetic sound tracks as well as the normal optical sound track. Originally designed for the Army to JAN Specs, is self-evidence of ruggedness. Design eliminates need for synchronizing pull down with sync generator. Light output is 50 lumens with a 300W, 25 hour lamp. — All functions "On", "Off", "Show", "Forward" or "Reverse" may be remotely operated, if desired.



### SPECIFICATIONS

- REEL CAPACITY: 2000'.
- SOUND: Optical and magnetic.
- LOOP SETTER: Push-button.
- SHUTTER: 120 cycles per second.
- LENS: 2" f/1.6 (up to 5.4 where desired).
- DISTORTION: 2% or less, 100-7000 cps.
- RESPONSE: 80-8000 cps ±1½ db.
- FLUTTER: 0.25% or less.
- POWER: 105-129 volts, 50/60 cycles.
- SIZE: (with pedestal) 51¾" high, 12¾" wide, 16¼" long. Lens to floor: 48" ±1".

Projector complete with pedestal ..... 614CBVM

## FRICITION HEAD TRIPOD



For vidicon or cameras 25 pounds or less. Equipped with friction type pan and tilt head, with tilt tension adjustment and pan and tilt lock levers. Equipped with spirit level. Range, 44½" low to 73" high. Legs of sturdy maple with quick positive locking devices.

- Professional Jr. friction head tripod ..... GR-975
- Carrying case for outside use ..... GR-976

## LENSES

As lenses are of various focal lengths, a complete listing will be found in the price list with this catalog.



# ACCESSORY EQUIPMENT

## KLIEGL FRESNEL LENS SPOTLIGHTS

Front and back spindle adjustment control. Heat resisting lens. Perfect light control without spill light or side glare. Adjustable from wide spread to minimum spot. Includes 3' asbestos leads and connector.

- 3" lens, 100/150W lamp ..... 44N3TVG
- 6" lens, 500/750W lamp ..... 44N6TVG
- 8" lens, 1000/1500/2000W lamp ..... 44N8TVG
- 12" lens, 2000W lamp ..... 44N12TVG
- 19" roller caster floor stand for 6" and 8" lens models ..... 1420CR
- 25" roller caster floor stand for 8" and 12" lens models ..... 1421CR



## KLIEGL POLE-OP 8" FRESNEL

Turns, tilts, adjusts barn doors — all by pole — from studio floor. Has 8" fresnel lens and basic light design very similar to 44N8TVG listed above. Includes C clamp, swivel, asbestos leads and connector. Pole is accessory item. Size: 23 1/2" high, including cradle. 13" wide and 13" deep.

- Pole-Op Klieglight ..... 44NP8G
- Sectional 12' pole, handle and loop ..... 44



## LAMP SIZES

For fresnel lights listed above, use following lamp sizes:

- 44N3TVG ..... 100/150W Bayonet Base
- 44N6TVG ..... 500/750W T20 Med. PF Base
- 44N8TVG ..... 1000, 1500, 2000W, G40 Mog. PF Box
- 44NP8G ..... 1000, 1500, 2000W, G40 Mog. PF Box
- 44N12TVG ..... 2000 watt, G48 Mog. BP Base

**IMPORTANT:** See price list for added discount to regular Kliegl light users applicable to TV stations.

## VIDEO PATCH PANEL



For patching coaxial circuits. 12 groups of 3 jacks on a strip 2 1/8" x 19". Contacts heat treated beryllium copper. Outer braid of coaxial cable may be soldered directly to jacks for complete shielding. Patch cords and plugs listed and illustrated below.

- Video patch panel ..... 963
- Looping plug ..... 965
- 18" patch cord ..... 967A
- 24" patch cord ..... 967B



## KLIEGLIGHTS

Klieglights are spot-flood lights and differ completely from plano-convex and fresnel lens units. Klieglights have been perfected to a degree that arc spotlights are no longer needed. Produce a brilliant, clear, uniform light, easily controlled and molded into any desired pattern. Perfect for highlighting areas or front spotlighting. Outstanding when used with projected scenery, as beam can be cut at any point. Available in hanging and floor models.

Klieglight for 250/500/750 watts up burning spot lamps. Included T14 Med. bi-post base, up burning spot lamps. Included are reflector, 4 independently adjusted square framing shutters, 6" stepped lens, asbestos wires, yoke and C clamp. Hanging type ... 1365EG

Same as 1365EG but with built-in iris shutter ..... 1365EG-IRS

Same as 1365EG but for 1500/2000 watt T base up burning, 200 hour life lamps ..... 1366EG

Same as 1366EG but with built-in iris shutter ..... 1366EG-IRS

Super Klieglight for 2000W T30 base up burning lamp. Rear operated curtain and iris shutter, 12" lens. Includes 25' cable, roller caster floor stand and switch. Rating, 450 foot candles at 4', spot at 25' ..... 1174G

Dyna-beam Klieglight similar to 1174G above but uses 3000W T32 base up burning lamp. Added feature, in-built rear operated horizontal spread lens which doubles width or projected spot when desired. Rating, 1000 foot candles at 4', spot at 25' ..... 1178G



## KLIEGL 18" SCOOP LIGHT



Popular Kliegl light has socket cap with universally adjustable yoke and C clamp, permitting straight down as well as up lighting. Spring tension adjustment. Light weight, ideal for field work. Hood of 16 gg. Alzak-finished aluminum. Includes 3' asbestos leads, connector and takes PS52 lamps from 750W to 2500W in size.

- Scoop Light ..... TV1155G

## HANGING DEVICES



Single spring counter-balance raising and lowering device for use with models TV111 scoop and 44N6TVG fresnel lens units, 360° horizontal rotation and vertical tilt. Illustrated to left. Ideal method of positioning light where needed ..... TV111

Same as TV111 only designed to hold fresnel lens model 44N8TVG ..... TV112

Double spring counter-balanced device as illustrated to right for use with 44N12TVG fresnel lens light ..... TV113

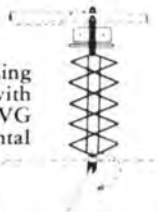

# CONRAC TELEVISION MONITORS



CMB 17/N

CMB 17/C

## CONRAC CMB TELEVISION MONITORS 14" - 17" - 21"

The Conrac CMB type video monitor incorporates many features normally found only in master monitors. It is especially designed for use in television broadcast control rooms, tape and film editing rooms and other locations where high resolution and excellent stability are required.

Video response is flat to beyond 10 megacycles, assuring resolution in excess of 800 lines. The final stage of the video amplifier employs two power tubes in parallel, providing high output with extremely low distortion. Differential gain is below 5% at 75 volts kinescope drive for excellent gray scale characteristics. The deflection circuits are capable of producing both horizontal and vertical linearity within 1% of picture height.

All operating controls, including electrical centering and electrical focus, are available on the front panel.

Of special interest is the picture size control which changes the display from normal full scan to reduced scan, completely showing all four sides and corners. This is accomplished without change in brightness, contrast or linearity.

Conrac-developed gating circuit eliminates the bending or "hooking" of vertical lines at the top of the picture regardless of setting of the horizontal hold control.

The kinescope employed is a newly developed electrostatic focus type. The spot size and shape are considerably improved over kinescopes in general use. Smaller spot size gives markedly improved resolution over the entire screen, and its superiority is particularly noticeable when viewing the corners. A 70° deflection system is used in all models of the CMB monitor.

The Conrac CMB monitor has fully regulated ultor and B + voltages, and will satisfactorily operate in areas having extremely poor powerline regulation.

A switch to select either composite video or separate video and composite sync inputs is provided. Both video and sync inputs are equipped with parallel receptacles for loop-through operation. The video input is provided with a terminating resistor switch.

A switch is provided to permit selection of either 100% or zero DC restoration.

The CMB monitor has been conservatively designed for continuous operation. Minimum service will be required to maintain the equipment in a satisfactory operating condition.

### Television Monitors, 14" - 17" - 21" (Please specify)

Chassis only .....	CMB/N
Rack Mounted .....	CMB/R
Cabinet Model .....	CMB/C



CNA8/2R

CNA8/C

## CONRAC CNA8 TELEVISION MONITOR 8" ONLY

The Conrac CNA8 monitor is a full scale broadcast quality video presentation device in a very small package. It is designed for broadcast and industrial television applications. The CNA8 presents a clear bright picture in continuous duty operation. A minimum amount of service is required to maintain the unit in top operating condition.

Video response is flat to 8 megacycles assuring resolution in excess of 600 lines. Differential gain is below 5% at 50 volts kinescope drive for excellent gray scale characteristics. The deflection circuits produce both horizontal and vertical linearity within 2% of picture height.

In a portable case, with carrying handle, the CNA8/C measures only 9 1/4" wide x 11 1/8" high x 18" deep. The compact chassis size permits mounting two monitors side by side in a standard 19" relay rack, and this assembly, Model CNA8/2R, requires only 10 1/2" of vertical rack space for two independent picture presentations.

8" Television Monitor, in portable case .....	CNA8/C
Chassis only .....	CNA8/N
Rack Assembly .....	CNA8/2R



## CONRAC CLB TELEVISION MONITOR 14" RACK MOUNT

The Conrac CLB is a general purpose video monitor. It is designed for broadcast and industrial television applications.

Video response is flat to 10 megacycles assuring resolution of 800 lines.

SIZE is 19" wide, 10 1/2" high, 17 1/2" deep. NET WEIGHT 57 lbs.

14" Monitor, Rack Mount Only ..... Model CLB

# ANTENNAS FOR TV AND FM

## MODEL TV-500

This antenna is designed specifically for low power TV. Consists of two sections of two rings each. One section is for visual and the other for aural. With this method, the diplexer is not required. As each ring has a power gain of 0.7, the two rings when stacked provide a power gain of 1.3. Thus, when used with normal transmission line lengths, unity power output is had, or a 100 watt transmitter will have an ERP of approximately 100 watts, or a 500 watt transmitter an ERP of approximately 500 watts.

Pattern is essentially omni-directional. Includes mounting mast with top plate for an obstruction light. Rings are provided with connecting coaxial cable and matching studs. Each antenna is tested prior to shipment. Impedance 50 ohms. Size of rings and spacing varies as to channel. Side mount antennas are also available.

- 500 Watts, Channels 2-6 ..... TV-500L
- 500 Watts, Channels 7-13 ..... TV-500H

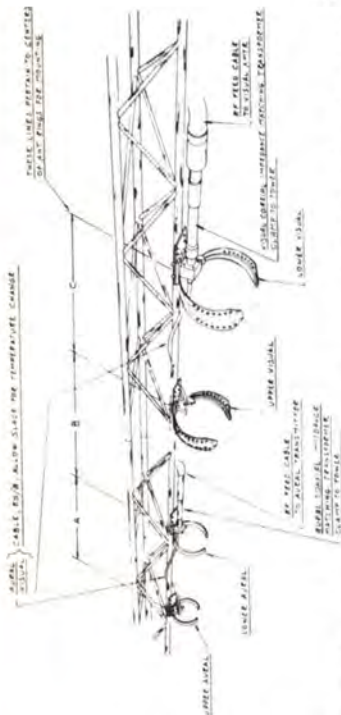

## LOW POWER FM ANTENNA

An omni-directional antenna for the 88-108 mc FM band, having a power gain of 0.8. Primarily designed for FM educational band but may be used at powers up to 1 kw. Design is broad band, greatly reducing standing wave problems due to changing climatic conditions. State frequency when ordering.



Two ring antenna, power gain of 1.3 .. Type FM-22  
Broad band antenna ..... Type FM-11

## JAMPRO ANTENNAS

Designed for use with medium to high power FM transmitters in the U.S., Jampro offers currently four types of antennas: two, four, eight and twelve bay. Power input varies from 5 to 55 kilowatts. Special antennas are available for pole mast type construction.

Air dielectric 7/8" coaxial cable is used in the two, four, and eight bay model harnesses. The twelve bay model uses 3 1/8" co-ax to junction boxes 63 feet long, plus 7/8" box to element co-ax in order to cut down harness losses.



## MULTI-V ANTENNAS

Omni-directional, this popular Andrew antenna for FM in the 88-108 Mc band is available in 2-bay, 4-bay, 6-bay, 8-bay, 12-bay, or 16-bay version. Mounts on side of tower and light weight allows use on nearly any type of tower. Power rating up to 10 kw. Standard design is for use with 1 5/8" coaxial cable. However, smaller cables may be used by purchasing a simple reducer. The Multi-V line has been field proven by many years of dependable service at hundreds of radio stations in the country.

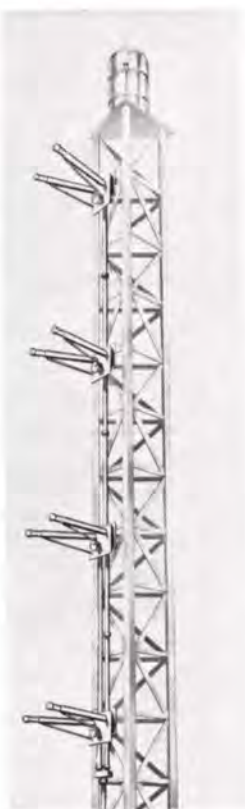

- 2-bay, power gain 1.6 ..... Type 1302
- 4-bay, power gain 3.7 ..... Type 1304
- 6-bay, power gain 5.6 ..... Type 1306
- 8-bay, power gain 7.3 ..... Type 1308
- 12-bay, power gain 10.0 ... Type 1312
- 16-bay, power gain 14.1 .... Type 1316

JAMBRO TYPE	JA-4	JA-8	JA-12
Gain over dipole in DM	5.7	8.6	10.8
Field intensity is MV/M (@ 1 mi/1 kw)	265	370	475
Vertical, aperture, in wave lengths	3	7	11
Power gain	3.7	7.25	12
Maximum power input	10 KW	20 KW	55 KW
Maximum VSWR @ 0.5 Mc bandwidth	1.2/1	1.2/1	1.2/1
Height in Feet	30'	70'	110'

## ELECTRIC GENERATING PLANTS

Electric and diesel generating plants are available in all powers from 1 KW to 500 KW. Pictured above is the popular Onan 25,000 generating plant. Ideal for use in providing complete power for radio and TV stations. Full information, prices, supplied upon receipt of customer's requirements.



# ANTENNA COUPLING UNITS

## ANTENNA COUPLER

### 1250 WATTS AND LOWER



A fully weatherproof coupler for series feed antennas to handle 1250 watts or less and at 100% modulation. Plug-in meter supplied, which may be inserted in either line or antenna circuit. Meter shorting switch is provided in antenna circuit to eliminate damage to meter during electrical disturbances. Antenna meter may be observed through glass porthole. Coil is silver plated, having generous inductance for arrangement in a full Tee

network along with the fixed mica capacitors supplied. Extra room is provided in the cabinet for either diode or thermocouple type remote metering kits.

### SPECIFICATIONS

CARRIER POWER: 1250 watts or less.  
 INPUT IMPEDANCE: 50 to 360 ohms concentric or open line.  
 ANTENNA RESISTANCE: 10 to 1000 ohms.  
 ANTENNA REACTANCE: Plus J 600 to minus J 300 ohms from 540 to 1000 kc.  
 Plus J 600 to minus J 500 ohms above 1000 kc.

CIRCUIT: Tee network.  
 LIGHTNING PROTECTION: Meter shorting switch.  
 METERING: Plug-in 3" meter normally located as antenna meter but may be used as line meter for tune-up. Plug-in shorting bar provided for unused meter jack.  
 REMOTE METERING: Provision for either thermocouple or diode type as ordered.

SHIPPING WEIGHT: 98 lbs.  
 SIZE: 20" high, 20 1/4" wide, 18 3/4" deep.

### ORDERING INFORMATION

IMPORTANT: Kindly state transmission line impedance, frequency, tower height and tower measurements if known.  
 Antenna Coupler with antenna meter ..... Model 44

## SERIES AND SHUNT FEED COUPLERS



Model M-5178: Series feed, provides all coil and capacitance to provide full Tee network. Constructed in non-weatherproof steel cabinet, front removable. Size: 21" high, 10" wide, 9" deep. Matches RF input of 50 or 70 ohms. Output 10-600 ohms. In this model metering is external to the coupler, often desirable in unattended operation. For all powers 100% modulated up to 1250 watts carrier.

Antenna Coupler .... Model M-5178

Model M-5179: Shunt feed coupler of coil and capacitor combination to tune out the reactance in shunt fed antenna coupling.

Same size as M-5178 above. Rating up to 1250 watts carrier 100% modulated.

Antenna Coupler ..... Model M-5179

IMPORTANT: Please state frequency, tower height and tower measurements, if known.

## 5-10 KW ANTENNA COUPLING UNITS



These two nearly identical models differ only in component size for 5 and 10KW power ratings. Housed in an aluminum cabinet with double front doors. Size: 38" high, 37" wide, and 21 1/2" deep. Antenna meter may be observed and meter shorting switch operated with the inner door closed. Coils are silver plated. Capacitors have generous voltage and current safety factor. All ratings are 100% modulated.

Tuning unit may be mounted by metal flanges at each back side. Usually two wooden poles, set in the ground, are used for mounting. A large lead in bowl is provided for antenna connection. The use of non-ferrous metal in the tuning house will prevent component heating under certain conditions.

### SPECIFICATIONS

FREQUENCY RANGE: 540-1700 kc, as ordered.  
 INPUT IMPEDANCE: 45-360 ohms, as ordered.  
 ANTENNA RESISTANCE: 20-1000 ohms.  
 REACTANCE: +J500 to -J500.  
 WEIGHT: Packed, 315 lbs. (export); 200 lbs. (domestic).  
 Unpacked, 136 lbs. Cubage, 24.

### ORDERING INFORMATION

IMPORTANT: When ordering, state carrier frequency, transmission line impedance, tower height and tower resistance measurements if known.

Coupling Unit for 5KW ..... M-5309A  
 Coupling Unit for 10KW ..... M-5309B

## HIGH POWER ANTENNA COUPLERS

### (50KW and 100KW)

For custom designed couplers in the 50,000 and 100,000 watt range, Gates can call upon a great deal of experience and skill. With a substantial supply of components on hand at all times there is a minimum of delay when designing a particular coupler.

Illustrated is a typical 100,000 watt shelf-type unit as employed in Israel. All materials are of the highest possible quality and exact specifications are always met. Couplers are available in weatherproof cabinets if desired.

When ordering, please supply all available information such as (1) power (2) frequency, (3) tower height, (4) ground conductivity if known, (5) tower measurements, if known, (6) transmission line impedance such as 50 ohms, 70 ohms, 250 ohms, etc., and whether coupler will be mounted in an out-building or if weatherproof type is desired.

Price of coupler can be quickly quoted with the above data supplied.



# TOWER CHOKES — ISOLATION COILS — SAMPLING LOOP

## SOLENOID TOWER CHOKES



Fig. A

Most popular of all tower light isolation chokes. Available in 2 or 3 section and in open type, illustrated to right, or weatherproof type, illustrated to left. Wound on XX heavy bakelite tubing with mica by-pass condensers on each circuit end. Inductance 350 uh. 3" stand-off insulators are part of coil. Size: choke only, 18 1/2" long, 5" diameter, 7 1/2" from bottom of insulator to top of coil. Weatherproof type, 24" high, 17 3/4" wide, 10 1/4" deep. Illustration to left shows front cover of weatherproof unit removed for photographing.

M-3937, 2-section, Fig. A      M-3935, 2-section, Fig. B  
M-3938, 3-section, Fig. A      M-3936, 3-section, Fig. B



Fig. B



## ISOLATION COIL

Inductance 85 uh. Made of Andrews type 83A coaxial cable, 50 ohms, mounted on heavy bakelite bars. Available in weatherproof model illustrated above (front cover removed) or coil only for mounting inside tuning house. Size (weatherproof model): 20" wide, 32 1/2" high, 18 1/2" deep. State carrier frequency and power when ordering. Includes all necessary elements to match purchasers frequency.

Weatherproof isolation unit ..... M-3073  
Coil only, less cabinet M-4561-A  
Weatherproof isolation unit with M-5573 coil (shown below) ..... M-5634

## AUSTIN RING TYPE TOWER CHOKE



Ring type tower choke is a transformer with clear air space between primary and secondary and resultant zero RF leakage. Independent of frequency. All models are for 115/230 volt primary and 115 volt secondary. Base insulator in photo for illustration purposes only.

Type	Capacity KVA	Mfg. Style	Net Wt. Lbs.	Attachments
A-2100	1 — 1.75	Side Bracket	81	none
A-2101	1 — 1.75	Side Bracket	85	Lt. gap
A-2102	1 — 1.75	Pedestal	82	none
A-2103	1 — 1.75	Pedestal	86	Lt. gap
A-1970	2 — 3	Side Bracket	188	none
A-1971	2 — 3	Side Bracket	201	Lt. gap
A-1972	2 — 3	Pedestal	182	none
A-1973	2 — 3	Pedestal	200	Lt. gap



Fig. A



Fig. B

## REMOTE METER KITS

Thermocouple Type: Fig. A above. Includes 3" square case meter, thermocouple, adjusting rheostat, chokes and capacitors. May be used up to 1000 of 2C No. 18 or larger line for remote metering between tuning house and transmitter.

- Complete (meter range 0-3 RFA) ..... M-3383
- Complete (meter range 0-5 RFA) ..... M-3133
- Complete (meter range 0-10 RFA) ..... M-3386

Diode Type: Fig. B above. Inductively connects to antenna lead for excellent protection against electrical disturbances. Uses 6H6 tube. Operates from 115 volt tower light circuit. May be used with 2C line up to 5000 feet. Available with or without meter. Standard 1 MA meter is employed. Ratings are 100% modulated.

- 1KW or less, 0-3 RF scale ..... M-3294
- 1KW or less, 0-5 RF scale ..... M-3294B
- 1KW or less, 0-10 RF scale ..... M-3294D
- 5/10KW, 0-5 RF scale ..... M-5334
- 5/10KW, 0-10 RF scale ..... M-5335
- Diode less meter, 1KW or less ..... M-3759
- Diode less meter, 5/10KW ..... M-2765B



Coil only ..... M-5573

## M-5573 ISOLATION COIL

Used in the same manner as the M-3073 and M-4561 shown above. The coil is wound of RG-11/U solid dielectric cable with an inductance of approximately 100 uh. Where the consulting engineer wishes to resonate the coil, a separate capacitor is required.

## PHASE SAMPLING LOOPS

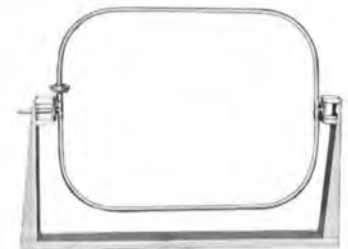

M-3283: This model especially applicable where high current ratios are to be sampled. May be rotated so that phase monitor amplitude values are nearly equal. Electrostatically shielded and insulated from tower. May be used with or without isolation coil at base of tower. Coil is single loop of 7/8" coaxial cable, heavily insulated from base frame. Matches either 50 or 70 ohm line. Size: 45" wide, 60" high.

Sampling Loop ..... M-3283

Ordering Sampling Loops: Unless for replacement purposes, it is always suggested that sampling loops be ordered on recommendation of the customer's consulting engineer. As the loop and its associated transmission line, and in some instances the isolation coil, are all part of the overall computations, the slight delay in checking with the consultant will often save time and expense.

## DIRECTIONAL PHASING EQUIPMENT

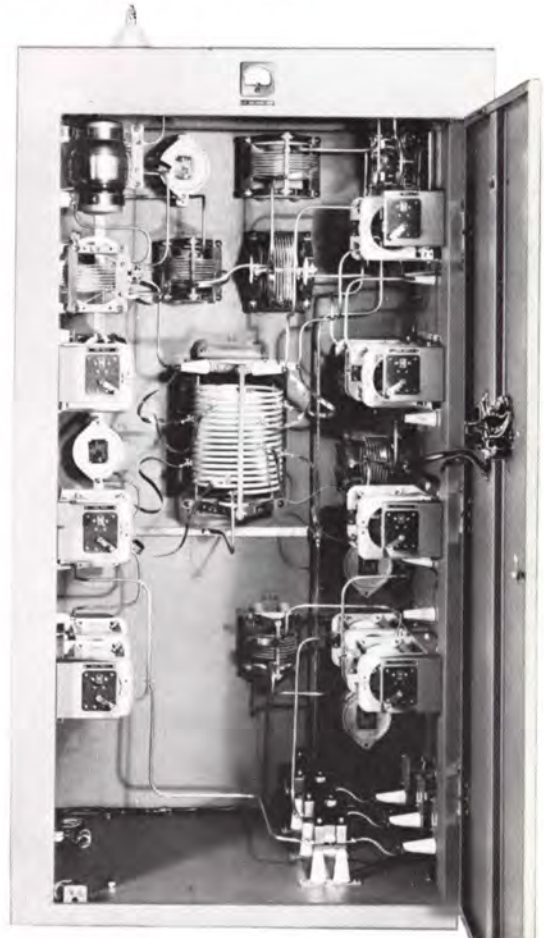
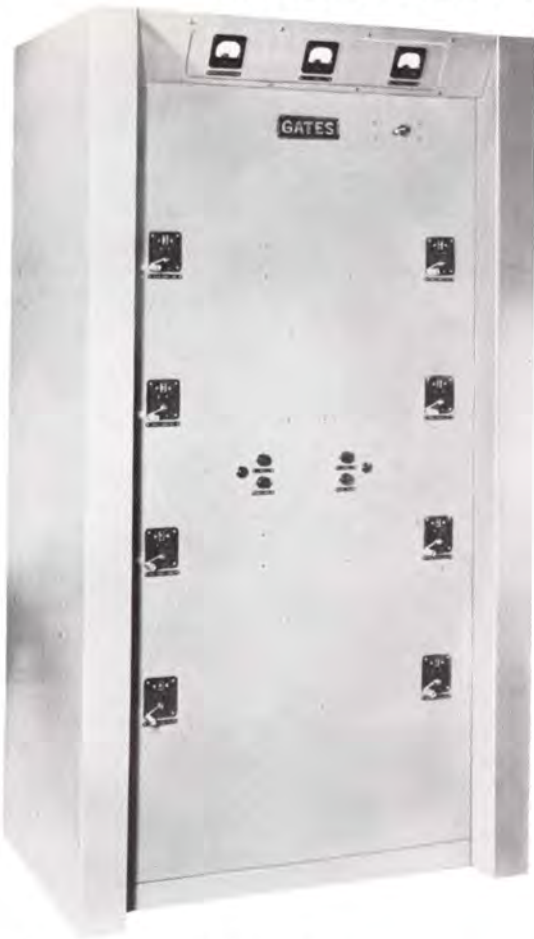

The total power of all Gates phasing equipment manufactured in the past decade, including more than half of all phasing equipment in the U.S., comes to several million watts. This immense range of power is valid testimony to the ideal combination of Gates' precision manufacturing and creative engineering experience that is unequalled in the broadcast industry.

Gates phasing equipment has for years, been the choice of the majority of broadcasters and has held a fine reputation for meeting the exact specifications of consulting engineers. Stability of pattern and reliability of components, many of which are manufactured by Gates and all of which possess generous over-rating, are reasons for the definite preference for Gates phasing equipment. Also, minimum tuneup and maintenance time make Gates phasers less expensive in the long run, though nothing is spared in the design cost. Gates manufactures phasing equipment up to 100 KW in power and for any number of elements.

The outcome of this unexcelled background and a sincere desire to give broadcasters the finest possible phasing equipment has resulted in the following Gates exclusives:

- The use of Gates manufactured silver plated coils for

better conductivity, more stable operation and greater system efficiency.

- Easy accessibility to every part for adjustment and maintenance.
- The use of Gates "full grip" variable inductors providing a high degree of stability for all front panel controls.
- The use of "make-before-break" meter switches that have inductance loops opposite the meter. These switches provide complete compensation for the inherent meter inductance which otherwise would cause the phase to change when the meter is switched out of circuit. This is extremely important today because of increasingly tight directional patterns.

All directional phasing equipment is manufactured to the exact specifications of the customer's consultant and work is not initiated until the consultant approves the design. Upon completion, the consultant receives all details covering what the design was based on and over what ranges the networks may be tuned.

Gates can provide immediate price quotations on phasing equipment up to 10,000 watts and 6 towers. Other prices are quoted promptly upon receipt of consultants specifications.

(con't)

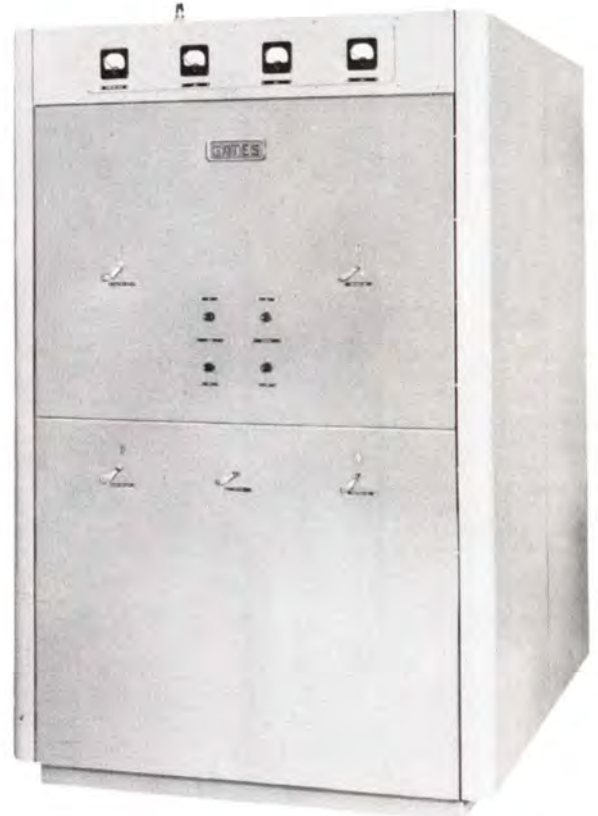
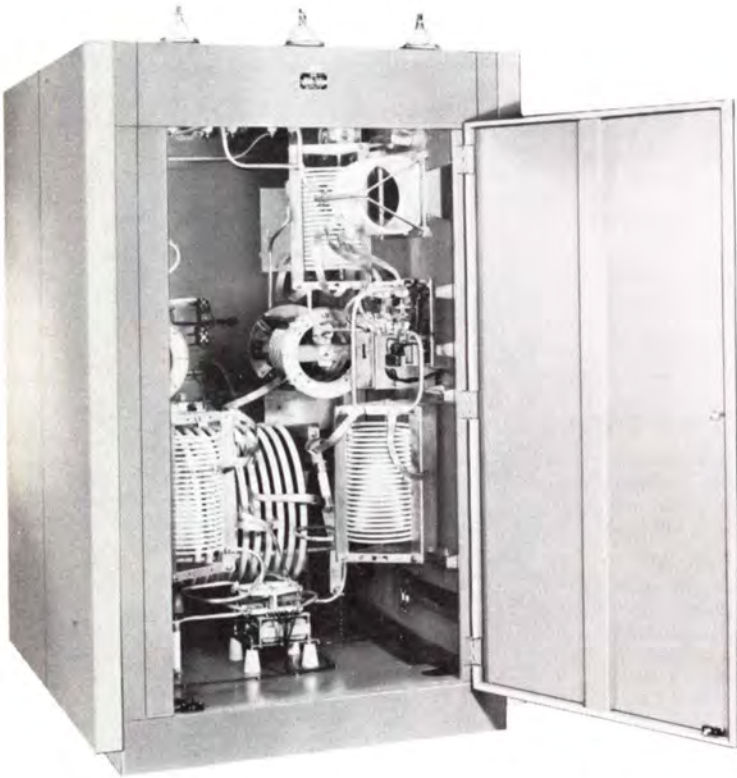
**DIRECTIONAL PHASING EQUIPMENT**

In high power phasing equipment of 50 and 100 kilowatts, Gates can call upon un-paralleled experience to custom build phasors covering the 4-30 mc short wave as well as the regular broadcast band.

All phasing equipment designs provide safety factors greater than 5.656 times the expected RMS voltages and at least twice the highest expected current in all portions of the system. Power dividing circuits are designed to provide power adjustment with a minimum of phase shift. Variable coils are replaced by variable vacuum capacitors to eliminate possible trouble with moving coil contacts. Operating efficiencies when properly adjusted are the highest attainable due to superior Q's of Gates coils. In all cases, a minimum of component types are used to reduce spare part inventories.

While Gates maintains a complete production department solely engaged in the construction of phasing equipment, all design and construction is under the supervision of the engineering department, from start to finish.

At this writing, some of the more recent users of Gates high power phasing equipment are as follows:

- CKVL — Verdun, Quebec
- XET — Monterrey, Mexico
- WINQ — Tampa, Florida

- Radio Free Europe
- Radio Rumbos, Curacas, Venezuela
- Dominican Republic
- Government of Israel
- Far East B/C Company, Okinawa

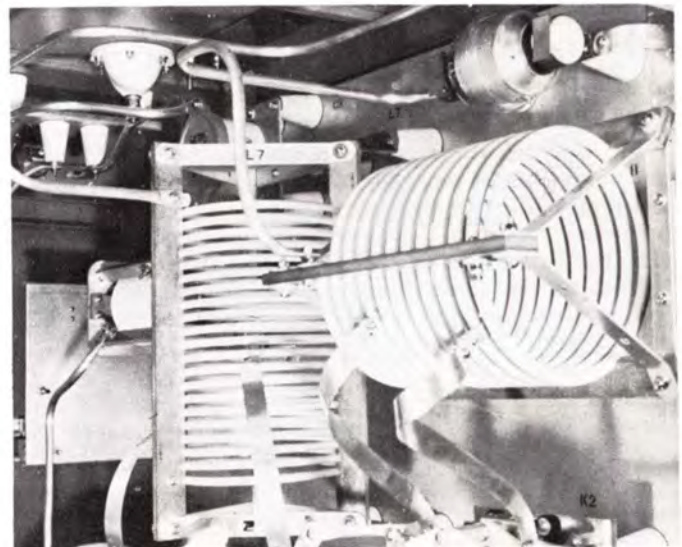

# ACCESSORY CABINET FOR RADIO BROADCAST TRANSMITTERS

Model GY-60B



All the necessary accessories to meet FCC requirements will be found in this cabinet. — At the top is the Gates FCC approved M-5693 modulation monitor and under this is the FCC approved M-4990 frequency monitor. Next in line is the SA-39B limiting amplifier, followed by the input switching panel. The switching panel accommodates two telephone lines, a local and auxiliary input (four in all) at 600 ohms. A second switch allows bypassing the limiting amplifier for emergency tube change in the limiter, etc.

Ample blank panel space is provided in the lower section of the cabinet for remote control equipment or any other desired accessory. The GY-60B accessory cabinet is completely wired, including coaxial cables to terminate the frequency and modulation monitors.

## SPECIFICATIONS GY-60B

**MODULATION MONITOR:** Gates Model MO-5693, fully FCC approved.\*

**FREQUENCY MONITOR:** Gates Model M-4990, fully FCC approved.\*

**LIMITING AMPLIFIER:** Gates Model SA-39B. Input and output impedances, 500/600 ohms.

**SWITCHING PANEL:** Four switch selected 500/600 ohm inputs, two for line input, one for local input such as microphone pre-amplifier, and one for auxiliary input such as turntable. Second switch is for bypassing limiting amplifier for on-air maintenance.

**POWER INPUT:** 115 volts, 50/60 cycles, approximately 390 watts.

**FINISH:** Two-tone gloss gray with escutcheons in anodized black.

**SIZE:** 78" high, 23½" wide, 19½" deep.  
Rear door swing 20".

**WEIGHT:** Net 290 lbs. Packed 405 lbs.

**CUBAGE:** 31.

\*Fully described elsewhere in this catalog. Please refer to Index.

## ORDERING INFORMATION

Complete accessory cabinet with one set of tubes.... GY-60B  
100% spare tube kit for GY-60B ..... TK-302



# BROADCAST FREQUENCY MONITOR

Model M-4990



The M-4990 AM frequency monitor provides the progressive broadcaster with added accuracy, greater reliability, smaller size, plus many other features which result in a monitor that once installed, performs with laboratory precision and minimum maintenance. Again the stability of Gates solid process printed wiring, adds to the demanded stability of a frequency monitor. Each wire in the same place is why each production model has prototype performance. The absence of parts stacking and the absoluteness of soldering in the printed wiring process continues the quality emphasis in an instrument that demands quality all the way.

A vacuum type crystal unit, precise to broadcast transmitter standards without temperature control, is mounted with its oscillator stage components within a carefully designed temperature controlled chamber to result in 1/2 part per million frequency accuracy.

The M-4000 frequency monitor is fully FCC approved.

A precision oscillator operates 1000 cycles below the carrier frequency. The output from the oscillator is isolated and amplified and then mixed in a detector stage with the radio frequency signal from the transmitter. This signal may be direct connected or when used in remote control (unattended) operation, the M-5549 whip antenna kit may be purchased for direct air monitoring over distances of 20 miles or more, depending on the transmitter power. The beat note from the detector is amplified and then applied to a discriminator. The output is rectified and applied to a DC meter calibrated in 1-cycle steps from -30 to +30 cycles.

The meter may be switched to several circuits including carrier level, frequency deviation, oscillator current and local/remote functions. Outstanding feature is the accuracy over a wide range of input voltages and modest fading conditions, when used with the antenna, will not affect operational stability.

Servicing of the M-4990 frequency monitor has the excellence of all Gates products. Front panel hinge down brings all adjustments to the operator's fingertips. Both the filament and plate voltage supplies are fully regulated to add to accuracy under varying line voltage conditions. Connections are provided for a remote reading frequency meter which may be used with a line up to 2000 ohms resistance equivalent to 21 miles of telephone line.

Temperature control of the crystal chamber is through a mercury thermostat operating with a relay. The thermostat employs a heater winding to minimize temperature fluctuations during each heating cycle. The heater itself is the blanket type for absolute even distribution. If the rarity of failure of the heater control circuit would occur, a thermal fuse will meet and no damage to components will result to assure quick repairs.

In designing the Gates M-4990 frequency monitor, Gates engineers have applied exacting standards. They have incorporated the basic requisite of a broadcast frequency monitor — accurate frequency measurement. Hundreds of Gates frequency monitors are in use today. The M-4990 takes the desirable features of these earlier models and adds advancement in tube, circuit and crystal designs to provide the most advanced monitor manufactured today.

## M-4990 BROADCAST FREQUENCY MONITOR



Front panel hinges down to expose operating adjustments and the plug-in crystal unit. Here is exhibited the uniformity of printed wiring to produce uniformity in year-in and year-out service.

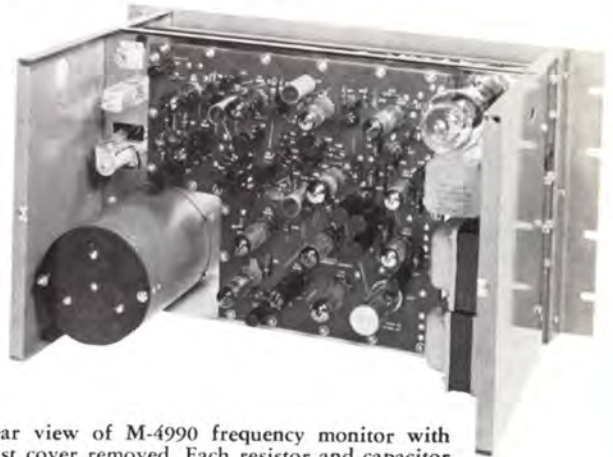

Rear view of M-4990 frequency monitor with dust cover removed. Each resistor and capacitor is firmly secured to the printed wiring chassis. Parts stacking is obviously absent.

### SPECIFICATIONS

**OSCILLATOR:** Electron coupled 1000 cycles below assigned frequency, crystal control.

**FREQUENCY RANGE:** 540-1600 Kc as ordered.

**DEVIATION RANGE:** Meter reads — 30/0/+30 cycles.

**INPUT VOLTAGE:** Supplied with external fixed pad to handle wide range of input voltages from 5-50 volts direct connected and down to 5 Mv with whip antenna.

**INPUT SIGNAL:** Modulated or unmodulated.

**INPUT IMPEDANCE:** 50/70 ohms.

**OVERALL STABILITY:** ±2 parts in one million.

**OSCILLATOR STABILITY:** ±0.5 parts in one million.

**LINE VOLTAGE:** 105-125 volts, 50/60 cycles at 85 watts.

**TUBES:** 12BY7A oscillator, 6AU6 oscillator amplifier, 6AU6 input amplifier, 6C4 mixer, 6AU6 audio amplifier, 6AU6 limiter, 6AQ5 cathode follower, 12AT7 AVC, 6AL5 discriminator rectifier, 6AL5 VTVM rectifier, 6X4 high voltage rectifier, 6AQ5's Series regulators, 6AU6 voltage amplifier, OB2 voltage reference, 13-4 Ballast.

**SIZE:** 19" wide, 10½" high, 10⅝" deep.

**FINISH:** Medium gloss gray.

**WEIGHT:** 32 lbs. net, 53 lbs. packed. Cubage 4.

### ORDERING INFORMATION

Frequency monitor with tubes and crystal, state frequency when ordering .....	M-4990
100% spare tube complement .....	TK-281
Remote frequency meter, reading —30 to +30 cycles, mounted on 5¼" x 19" rack panel finished in gray .....	M-5631
Whip antenna with coupler to match RG/59U cable and monitor .....	M-5549



Above is the crystal oscillator unit, heart of the M-4990 frequency monitor. The open view illustrates the vacuum crystal, under which are the oscillator components, all temperature controlled. The oscillator tube, however, is external to the temperature chamber. The entire unit is plug-in and there are no variable air gaps for frequency adjustment at time of installation.

# BROADCAST MODULATION MONITOR

Model M-5693

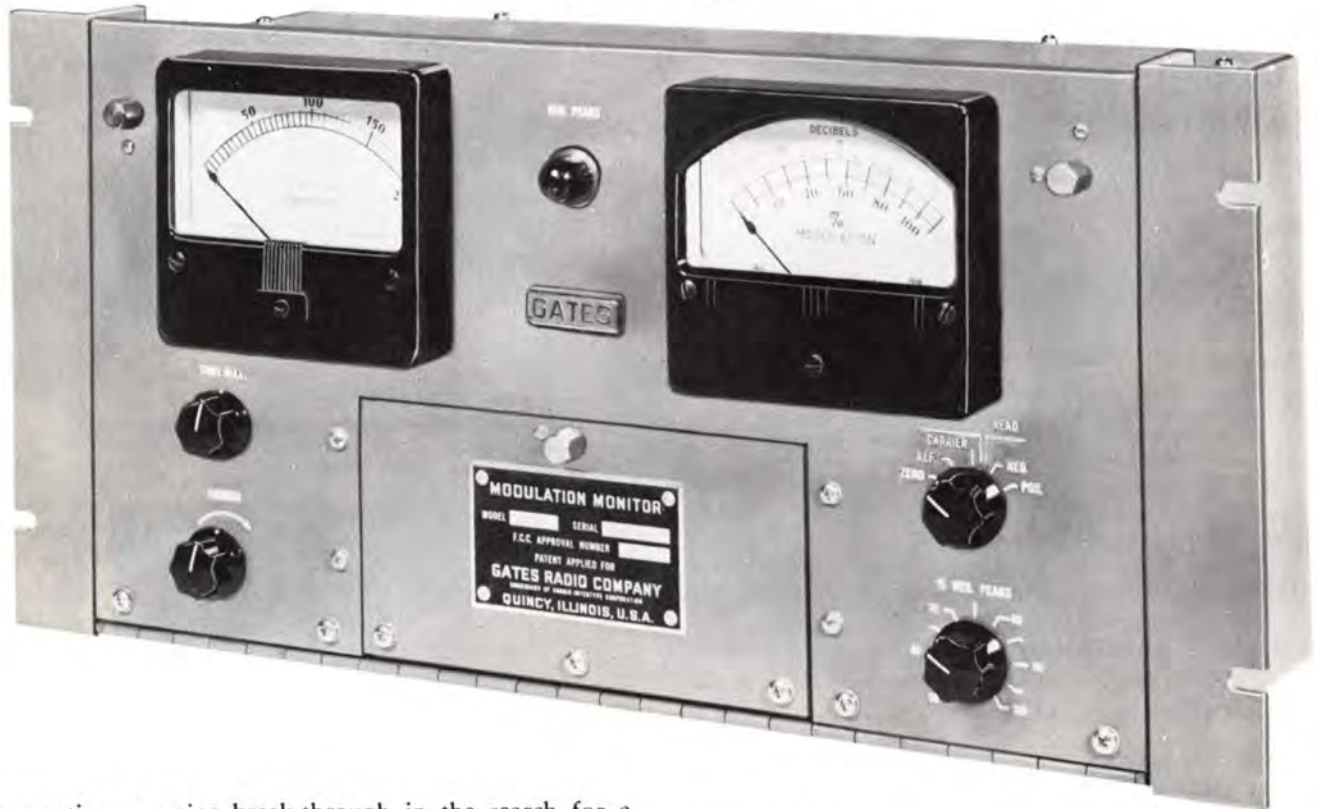

Representing a major break-through in the search for a better modulation monitor, the new Gates M-5693 modulation monitor operates on an entirely new principle. The result is much greater accuracy and the maximum use of the transmitter modulation capacity. Employing direct coupling, the M-5693 monitor will read the true values of positive and negative peaks regardless of the presence of carrier shift. With the fastest meter allowable, it will give correct peak indications on single program pulses as short as approximately 50 milliseconds and will measure the true peak amplitude of program or tone regardless of the wave forms encountered.

In the operation of this new monitor, the rectified carrier voltage with its audio, due to modulation, is compared with a stabilized internal reference voltage and, in the case of both positive and negative peak indication, the *difference* of these voltages operates the modulation percentage meter.

Older modulation monitors required the engineer to provide certain safety factors to prevent over modulation. The new M-5693 monitor with true peak indication regardless of the complex waveform in standard programming, assures accuracy to the point that often greater modulation of the transmitter is possible, resulting in valuable increased signal strength.

As noted, the new Gates modulation monitor uses the *difference* in the rectified carrier voltage and the reference voltage, and error from carrier shift decreases as the percentage modulation increases. The error is zero for 100% modulation. Indication of exact readings at high modu-

lation is now possible and downward allowance for the error factor is no longer necessary. The flashing light of the M-5693 monitor, which reads only the negative peaks, uses the difference between the peak of the audio component and all, or a portion of the DC component of the rectified carrier, depending on where the negative peaks switch is placed. Very accurate indications are the result. This method also reduces error from carrier shift to a very low value.

The Gates M-5693 monitor can be calibrated in a few moments, and does not require a modulated carrier to do so.

To measure audio output, response and distortion, the self-calibrating feature and the accuracy of indication makes this new monitor ideal for the annual proof-of-performance measurements. No additional RF samples are required, such as a diode rectifier for operating the distortion meter. An oscilloscope is not necessary. The engineer will certainly welcome the M-5693 monitor after using it on one proof-of-performance run.

The new monitor can be located at the transmitter and operated by remote control, with compensating adjustments in the monitor for imperfect telephone lines. The optional M-5834 remote meter panel is available for remote control. Light and compact, the M-5693 monitor is extremely accessible for servicing — the smallest part can be easily reached in seconds. The popular drop down front panel permits nearly all servicing from the front.

## BROADCAST MODULATION MONITOR

### SPECIFICATIONS

**FREQUENCY RANGE:** 540-1600 Kc.  
**RF INPUT IMPEDANCE:** Matches 50-75 ohm lines.  
**RF INPUT LEVEL:** Approximately 10 volts, R.M.S.  
**MODULATION RANGE:** Meter: 0% to 100% on negative peaks, 0% to 110% on positive peaks.  
 Flasher: 50% to 100% on negative peaks in steps of 5%.  
**RESPONSE:** Meter: Within 0.2 db, 50-15,000 cycles.  
 Flasher: Within 0.6 db, 20-7500 cycles.  
**ACCURACY:** Meter: 2% of full scale at 1000 cps, for any percentage of modulation.  
 Flasher: 2% of full scale dial calibration at 1000 cps.  
**RESPONSE TIME:** Meter: Meter responds to 90% of correct reading with a 50 millisecond pulse of modulation. Needle returns to 10% of reading in 500-800 milliseconds after signal is removed.  
**RESPONSE TIME:** Flasher: 15 milliseconds.  
**CIRCUITS:** Meter: (1) Direct coupled amplifier responds correctly to non-symmetrical modulation waveform.  
 (2) High speed meter.  
 (3) Self-calibration.  
 Flasher: (1) Direct coupled flasher shows accurately negative peaks of modulation regardless of waveform.  
 (2) Self-calibration.  
 (3) The flasher also serves as a carrier-failure alarm.  
**DETECTOR LINEARITY:** Negative peak clipping in the detector diode is negligible for frequencies up to 7500 cps. and 5% or less at 10,000 cycles.

#### MONITORING OUTPUT:

*When feeding a 600 ohm unbalanced load:*

Level: -20 dbm at 100% modulation.

Response: ± 0.2 db from 50-15,000 cycles.

Distortion: Less than 0.25% from 20-15,000 cycles.

Noise: At least 65 db below maximum output of -20 dbm.

*When feeding an open circuit (grid):*

Level: 0.75 volts R.M.S. at 100% modulation.

Response: +0.2 db from 50-15,000 cycles.

Distortion: Less than 0.1% from 20-15,000 cycles.

Noise: At least 65 db below maximum output of 0.75 volts.

**LOADING EFFECT:** 1000 mmf (12 ft. of single conductor shielded cable rated at 85 mmfd per ft.) at 15,000 cycles is about 0.1 db.

**OUTPUT MEASUREMENTS:** *With a load of 100,000 ohms or more, shunted by a simulated cable capacity of 500 mmf capacitance or less:*

Response: ±0.5 db from 20-30,000 cps.

Distortion: Less than 0.5%.

Noise: 75 db below maximum output of 4.5 volts R.M.S.

**POWER SUPPLY:** 105 to 125 volts, 50/60 cycles.

**POWER CONSUMPTION:** 70 watts.

**AUXILIARY OUTPUTS:** Connections for remote percentage modulation meter.

**TUBES:** (2) 12B4A, (3) OA2, and (1) each — 6X4, 5879, OB2, OC2, 5687, 12AU7, 2D21, 8-4.

**MOUNTING:** Rack mounted 19" x 8¾" panel, 11½" depth behind panel.

**WEIGHT:** 25 lbs.

**FCC APPROVAL NUMBER:** 3-109.

### ORDERING INFORMATION

Modulation monitor, complete with tubes ..... M-5693  
 100% set of spare tubes ..... TK-345  
 Remote meter panel ..... M-5834

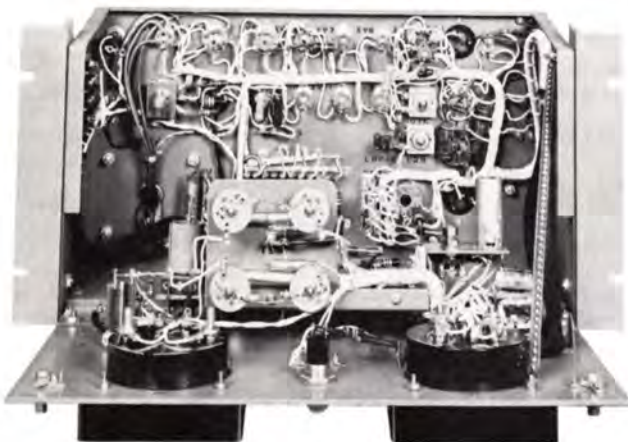

Front Panel Hinges  
Down For Complete Accessibility



Closed Rear View

Patent is applied for.

# SHORT WAVE MODULATION MONITOR

Model M-5774

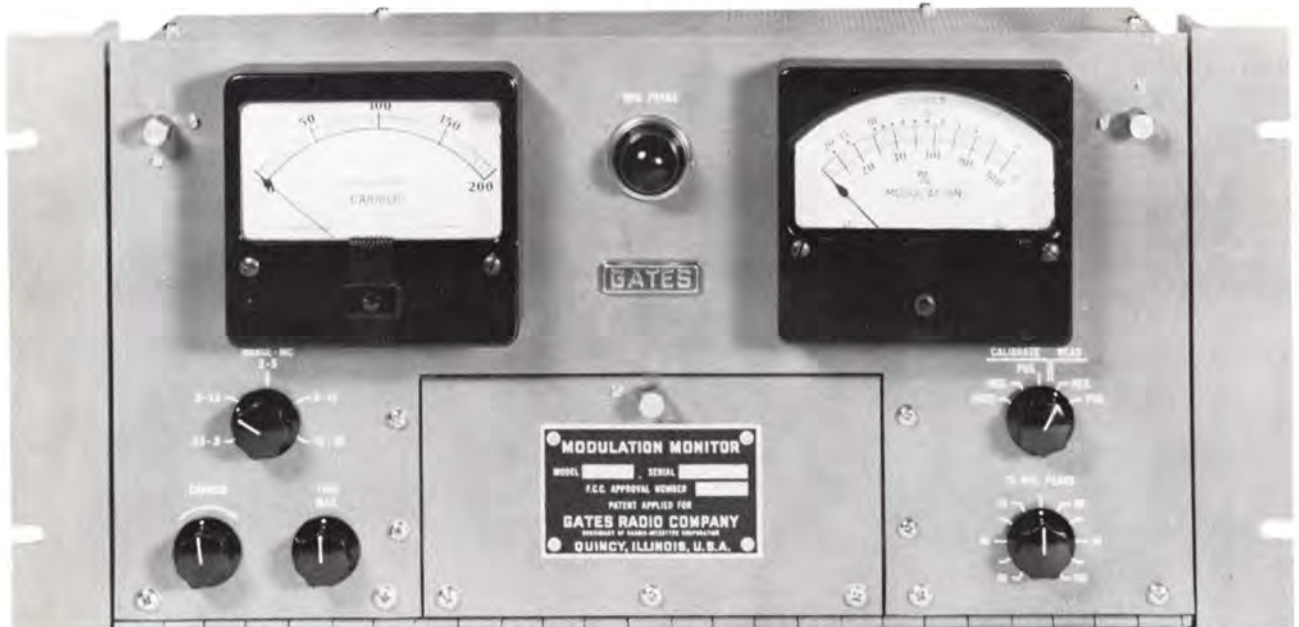

The new Gates M-5774 short wave modulation monitor, operating on an entirely new principal, is designed to give the truest indication of modulation percentage of any present day type.

An extremely fast meter with a 20 second millisecond modulation pulse, responds correctly to very short peaks of modulation. The meter is self-calibrating which means it does not need the presence of an un-modulated carrier and the over-modulation lamp circuits may be calibrated easily without the use of an oscilloscope. Employing direct coupling, this new monitor will read the true values of positive and negative peaks regardless of the presence of carrier shift — responds correctly to non-symmetrical waveform. The use of DC supply for the overmodulation lamp thyatron insures indication of short peaks which might be missed if AC were applied to the plate circuit of the thyatron.

## SPECIFICATIONS

**FREQUENCY RANGE:** 540/1600 Kc, 2-30 Mc.  
**RF INPUT IMPEDANCE:** Approximately 75 ohms.  
**RF INPUT LEVEL:** Approximately 10 volts.  
**MODULATION RANGE:** Meter — 0% to 100% on negative peaks, 0% to 110% on positive peaks.  
 Flasher — 50% to 100% on negative peaks in steps of 5%.  
**RESPONSE:** Meter — Within 0.2 db 50-15,000 cycles.  
 Flasher — Within 0.6 db 20-7500 cycles.  
**ACCURACY:** Meter —  $\pm 2\%$  full scale at 1000 cps for any percentage of modulation.  
 Flasher —  $\pm 2\%$  of full scale dial calibration at 1000 cps.  
**RESPONSE TIME:**  
 Meter — Meter responds to 90% of correct reading with a 50 millisecond pulse of modulation. The meter overshoots 2 to 3% on a step function signal. Needle returns to 10% of reading in 500 to 800 milliseconds after signal is removed.

Flasher — Responds to a 15 ms. pulse of modulation and remains on for about 1/5 second.

### CIRCUITS:

- Meter — (1) Direct coupled amplifier responds correctly to non-symmetrical modulation wave form.  
 (2) High speed meter circuit.  
 (3) Self-calibration without external equipment.  
 Flasher — (1) Direct coupled flasher shows accurately negative peaks of modulation regardless of waveform.  
 (2) Flasher uses a D.C. plate supply, causing all over-modulation peaks to be indicated.  
 (3) Self-calibration.

**DETECTOR LINEARITY:** Negative peak clipping in the detector is negligible for frequencies up to 7500 cps and does not exceed 5% at 15 kc and 100% modulation.

**MONITORING OUTPUT:** When feeding a 600 ohm unbalanced line:

- Level — 20 dbm at 100% modulation.  
 Response —  $\pm 0.2$  db from 50 to 15,000 cycles with 100 cycle reference.  
 Distortion — Less than 0.25% from 20-15,000 cycles, (not including detector distortion).

Noise — At least 65 db below maximum output of 20 dbm.  
**POWER SUPPLY:** 105 to 125 V. (or 115 to 135 V.) 50/60 cycles power consumption is 100 watts.

**AUXILIARY OUTPUTS:** Connections at the rear of the instrument for an external meter or external negative peaks lamp.

**TUBES:** (1) G234/5AR4 (type 5R4-G7 and 5V4G are directly interchangeable). (1) 6080, (1) 5879, (6) OA2, (2) CB2, (1) 2021, (1) OC2, (1) 12AX7, (1) 5687, (1) 12AU7, (1) 8.4.

**MOUNTING:** Rack mounted 19" x 8 $\frac{3}{4}$ " panel, 11 $\frac{1}{2}$ " depth behind panel.

**WEIGHT:** 27 lbs.

## ORDERING INFORMATION

Modulation monitor, complete with tubes ..... **M-5774**  
 100% set of spare tubes ..... **TK-346**  
 Remote meter panel ..... **M-5836B**

# ACCESSORY EQUIPMENT

## PHASE MONITOR

### SPECIFICATIONS

FREQUENCY RANGE: 100 Kc to 2000 Kc (as ordered).  
 PHASE ANGLE RANGE: 0-360 degrees.  
 MONITORING ACCURACY: 1 degree.  
 RESOLUTION: 1/2 degree.  
 RF INPUT IMPEDANCE: 50 or 70 ohms (as ordered).  
 RF VOLTAGE RANGE: 1-7 volts.  
 SIZE: 14" high, 19" wide, 7" deep.  
 POWER: 115 volts, 50/60 cycles, 80 watts.  
 TUBES: (2) 6AU6, (2) OB3, (3) 6AL5, (1) 5Y3.

### ORDERING DATA

Two Towers ..... Model 108D  
 Three Towers ..... Model 108E  
 Four Towers ..... Model 108F



**Model 108 (more than four towers) on request**

When Ordering: State carrier frequency, remote meter ranges, type of sampling line or impedance and carrier power.

Recognized as the finest phase meter built today. Available in standard models up to 4 towers. Special designs above 4 towers readily available. The Clarke 108 phase meter comes with remote antenna current meters and is unaffected by modulation. Operation has been simplified. Two selector switches are set to elements to be compared and the outputs of the amplifiers are adjusted to a red line on the meters. By a flip of a switch, the phase difference is indicated.

## FM MONITOR

Made by Hewlett-Packard and FCC approved for measuring frequency and modulation percentage of standard FM broadcasting stations with  $\pm 75$  Kc swing. No adjustments necessary during operation and is not necessary to re-set carrier level or realign circuits. Electronic counter circuits are unusually stable—require no adjustment except at long intervals. Very popular and used in scores of laboratories. Be sure to state frequency when ordering. Panel size: 10 1/2" x 19", for 115 volts, 50/60 cycles.

FM Monitor ..... 335BR



## FIELD INTENSITY METER

OUTPUT INDICATORS: Panel meter, direct reading, with logarithmic scale graduated 1 to 10 and HAVING NO ZERO MARK (needle is OFF SCALE when meter is not energized). Provision for using recorder, and headphones.

ANTENNA: Shielded unbalanced loop.  
 BATTERIES: Five 1 1/2 volt A. Two 6 7/2 volt B.  
 BATTERY LIFE: Approximately 500 indications.  
 TUBES: (4) 1T4, (2) 1R5.  
 SIZE: 9" high, 13" wide, 5 3/4" deep (closed).  
 WEIGHT: 12 1/2 lbs.

Field Meter, less batteries ..... Model 120D



NOTE: As standard batteries are employed, it is recommended that batteries be procured locally as needed.

The Clarke 120D (formerly WX-2D) field meter is for measurement of radio signal intensity in the broadcast band between 540-1600 Kc. Sensitivity from 10 microvolts to 10 volts per meter, makes it equally effective for interference studies and close in measurements of high power directional arrays. — For measurements of any directional system or signal intensity, this test instrument is indispensable. — The 120D meter is battery operated, weighs only 12 1/2 lbs. and is direct reading.

### SPECIFICATIONS

FREQUENCY RANGE: 540-1600 Kc.  
 FIELD INTENSITY RANGE: 10 microvolts to 10 volts per meter.  
 ACCURACY OF ATTENUATORS: 2%.

# TRANSMITTER CONTROL CONSOLE



For use with any standard or short wave broadcast transmitter to provide several input circuits, extension audio indicating meters, remote start/stop functions and associated indicator lamps. Functional diagram at bottom of page outlines generous facilities available. Where desk is desired, see Index (Desks).

## SPECIFICATIONS

**INPUTS:** Three provided with line isolation transformer for each circuit, 50/150/600 ohms ladder type controls, 20 steps, 2 db each.

**OUTPUT:** 600 ohms.

**MASTER GAIN:** Balanced 30 steps, 1.5 db per step.

**VU METER:** 4" square case with range control +4 to +40 VU in two VU steps for bridging 600 ohm line. Scale illuminated.

**MODULATION METER:** 4" square case illuminated.

**PUSH BUTTONS:** Four pairs provided (black start-red stop) to cover all possible combinations including automatic reset as featured in many Gates models.

**PILOT LIGHTS:** Provided to indicate filament and plate on.

**FINISH:** Medium hand rubbed gloss gray with escutcheons in black.

**SIZE:** 24" wide, 10" high, 21 1/2" deep. Cabinet swings up from base for servicing. See illustration below.

**SHIPPING WEIGHT:** 60 lbs.

## ORDERING INFORMATION

Model CCD2, Speech Input Console ready to install ..... **M4055**

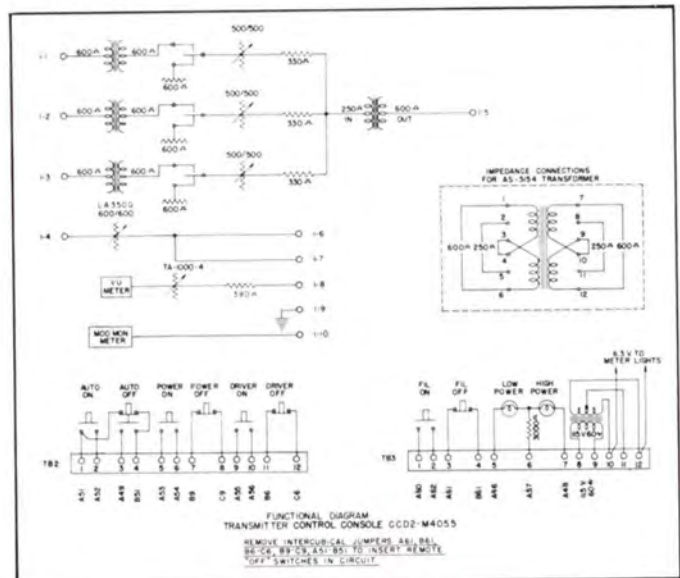

# REMOTE CONTROL SYSTEM

Model RDC-10C



**Metering:** Three 4" large scale meters calibrated in; (a) DC plate volts, (b) DC plate current, and (c) RF amperes. Plate voltage and plate current sampling units for transmitter installation, are supplied (see Ordering Information for list of items supplied).

**Functions:** The RDC-10C equipment provides; (a) 10 possible metering positions, (b) 23 possible control functions, (c) relay switching of both filament and plate and meets full Conelrad requirements, (d) constant voltage source is provided for line checking, and (e) metering positions are rotary switch selected, requiring no dialing. Fail-safe protection is provided on the filament control circuit. Up to 18 added switching functions may be handled by the choice of many accessories listed in this catalog, gladly supplied on request.

**Installation:** To install the RDC-10C equipment usually requires an evening's work. In some transmitters, perhaps a little longer. The studio unit may be rack, desk or wall mounted. The panel size is 8 $\frac{3}{4}$ " x 19" and power supply is self-contained. The transmitter unit is also 8 $\frac{3}{4}$ " x 19" and is usually mounted in the rack cabinet associated with the transmitter. At the transmitter, the plate current and plate voltage extension units for remoting these FCC required meters are connected in the meter circuit with a pair from each extension unit, returned to the RDC-10C transmitter unit. In transmitters of 1000 watts power or less, the motor tuned plate rheostat is installed in the transmitter in series with existing rheostat in the transmitter and also connected to the RDC-10C transmitter unit. For remote antenna current reading, a diode rectifier is used and supplied with some models (see Ordering Information). The tower light indicator is a small current transformer and remotes back to one of the meters

at the studio unit, indicating On-Off and pulses in beacon flashing, as well as the steady current of the obstruction lights. Two telephone lines are used between studios and transmitter. However, one of these lines may be used for order telephone service also.

**Remote Monitoring:** Several Gates accessories are available for remote monitoring. These are either extension meters for the frequency and modulation monitors or a radio frequency amplifier for air pickup of the monitors which would then be installed at the studios. These accessories are all listed in the catalog. Gates will gladly assist in the selection of proper accessories by your advising us of the type monitors.

**General Engineering Information:** The RDC-10C system is a DC system and does not employ tubes or transistors. Solid state rectifiers are used for DC circuits. Design is based on a maximum telephone line loop resistance of 3000 ohms, or based on 96 ohms resistance (maximum) per mile, the RDC-10C system may be used on good lines up to 30 miles. However, where the entire length of the telephone line is in cable, i.e., many lines in one cable, wherein capacity would increase, the maximum length is about 20 miles. As the usual line from studio to transmitter is much shorter, this is unimportant. The stepping relay, heart of the system, is a well-known telephone type used in dial systems and has gold plated contacts for trouble-free operation. The hinged down front panels for servicing of both transmitter and studio units will be appreciated by the engineer. Power source is 115 volts, 50/60 cycles. The RDC-10C system is FCC approved.

**Directional Operation:** For directional operation, the RDC-10C system will serve equally well. For the complex directional system, Gates has a Model RDC-200A.



## RDC-10C REMOTE CONTROL SYSTEM

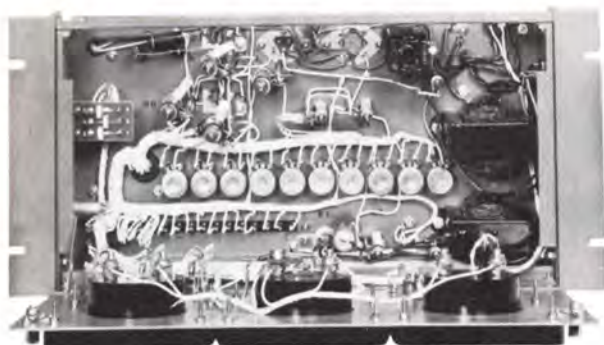

Studio unit has drop-down front panel so all parts can be reached from front of rack. Panel size of 8 3/4" x 19" conserves badly needed rack panel space.



The transmitter unit is absent of front panel controls, has drop-down front panel to service and only requires 8 3/4" x 19" panel space. Small size even allows mounting in some transmitters where room prevails.

### ORDERING INFORMATION

- (A) RDC-10AC basic unit includes studio and transmitter units and also  
Items I, J and K below ..... M-5862
- (B) Antenna diode unit for powers up to 1250 watts ..... M-3759
- (C) Antenna diode unit for powers over 1250 watts ..... M-2765B
- (D) Motor and rheostat assembly for 250 watt transmitter ..... M-4703A
- (E) Motor and rheostat assembly for 500 watt transmitter ..... M-4703B
- (F) Motor and rheostat assembly for 1000 watt transmitter ..... M-4703C
- (G) Motor assembly for tuning variable connector or coil for power adjustment  
of 5KW or 10KW transmitters in output coupling circuit  
(must be used with H below) ..... M-5066
- (H) Relay assembly to control M-5066 motor ..... M-4806
- (I) Plate current unit, extends plate current reading ..... M-4720A
- (J) Plate voltage unit, extends plate current reading ..... M-4719A
- (K) Tower light indicator ..... M-5254

- COMPLETE PACKAGES:**
- RDC-10C complete system for 250 watts includes A,  
B and D above ..... M-5876
  - RDC-10C complete system for 500 watts includes A,  
B and E above ..... M-5877
  - RDC-10C complete system for 1000 watts includes A,  
B and F above ..... M-5878

**WHEN ORDERING:** Please give as much detail as possible such as make of transmitter, size of present plate rheostat in ohms and watts and any helpful peculiar information. For higher powers, order by item and not packages. See catalog index for other accessories for both AM and FM.

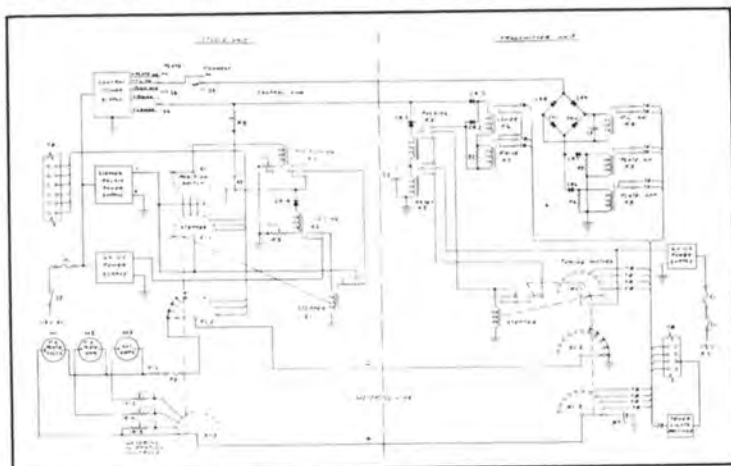

# RDC-200A DELUXE REMOTE CONTROL SYSTEM



Studio Unit



Transmitter Unit

This system will handle the complicated directional system of several transmitters or the utmost in dependability for any transmitter power up to 50,000 watts.

Model RDC-200A is an advanced design of a DC operating system. Simplex, phantom or natural ground returns are eliminated in favor of a straight wire return. Two wire pairs are the maximum requirement for any requirement of one or several transmitters, directional operation and tower light indication. With this system, wire lengths of as much as 60 miles provide no problem.

Highest current drain of any switching function in 6 MA, making the system almost impervious to line resistance change. These additional features will be of interest:

1. A total of 39 metering positions — 9 for internal metering (calibrated), plus calibrate position, 9 more for external metering (calibrated) and 19 external meters (not calibrated) for "off-on" indications. (These may be calibrated with internal or external potentiometers.) 1 meter for power light indication is also provided.
2. As wired, provides 78 switching circuits.
3. All DC control circuits. Operates through maximum loop resistance of 5000 ohms. Based on resistance of smallest underground cable, would equal 52 miles.
4. All necessary equipment for one transmitter is standard equipment. Includes: (a) plate current metering unit, (b) plate voltage metering unit, (c) plate voltage on-off relays, and (d) tower light indicator with current transformer. Diode unit for antenna current should be ordered separately.
5. 100% front panel accessibility via drop-down front panel. Panel size: 19" x 15<sup>3</sup>/<sub>4</sub>".
6. Function dialed indicated by illuminated number on front panel. Chart on front panel permits instant number to function observation for checking.
7. Same light indication on transmitter unit, with chart as in Par. 8 above.
8. Through a combination of sensitive relays, polarizing diodes and biasing, positive control is insured at low current drain. Husky slave relays provide the necessary contact rating for external switching circuits.
9. Pulse, reset and all switching functions can be controlled from transmitter for local operation.
10. Complete front of rack accessibility through drop-down-to-service feature. Panel size: 19" x 15<sup>3</sup>/<sub>4</sub>".
11. All of the standard demands of complete remote control equipment will be found in the Gates RDC-200A meeting FCC requirements including fail safe. Transmitter and studio units have self-contained power supplies and are independent operating units.

## STUDIO UNIT

1. Three 4" wide scale meters calibrated in plate volts, plate current and RF amperes. Pick the meter with the most appropriate scale for any other readings. 100 microampere meters used throughout.

## TRANSMITTER UNIT

2. Same light indication on transmitter unit, with chart as in Par. 8 above.
3. Through a combination of sensitive relays, polarizing diodes and biasing, positive control is insured at low current drain. Husky slave relays provide the necessary contact rating for external switching circuits.
4. Pulse, reset and all switching functions can be controlled from transmitter for local operation.
5. Complete front of rack accessibility through drop-down-to-service feature. Panel size: 19" x 15<sup>3</sup>/<sub>4</sub>".

All of the standard demands of complete remote control equipment will be found in the Gates RDC-200A meeting FCC requirements including fail safe. Transmitter and studio units have self-contained power supplies and are independent operating units.

# RDC-200A DELUXE REMOTE CONTROL SYSTEM

## REMOTE CONTROL ACCESSORIES

With RDC-200A the only special applications would be with the type and amount of accessory equipment. Where an extra special application is required, Gates will be happy to place into action the manufacture of this special need in its model shop, known for speed.

### What is Supplied:

As standard equipment, the following is supplied:

- (a) Studio remote control unit
- (b) Transmitter remote control unit
- (c) M-4719A plate voltage metering unit
- (d) M-4720A plate current metering unit
- (e) Inbuilt plate start-stop relays for one transmitter
- (f) Tower light indicator

NOTE: Motor tuned plate voltage rheostats are listed in this catalog for powers up to 1 KW along with motor tuning assemblies for load adjustments of higher power transmitters. There are optional accessories for your particular need and should be ordered for the complete system. Where more than one transmitter is to be remote controlled, the M-5249 momentary control or M-5248 latching (hold type) control is employed.

## ORDERING INFORMATION

Complete deluxe remote control system .....	RDC-200A
Extra tower light indicators (for multiple towers) .....	M-5145

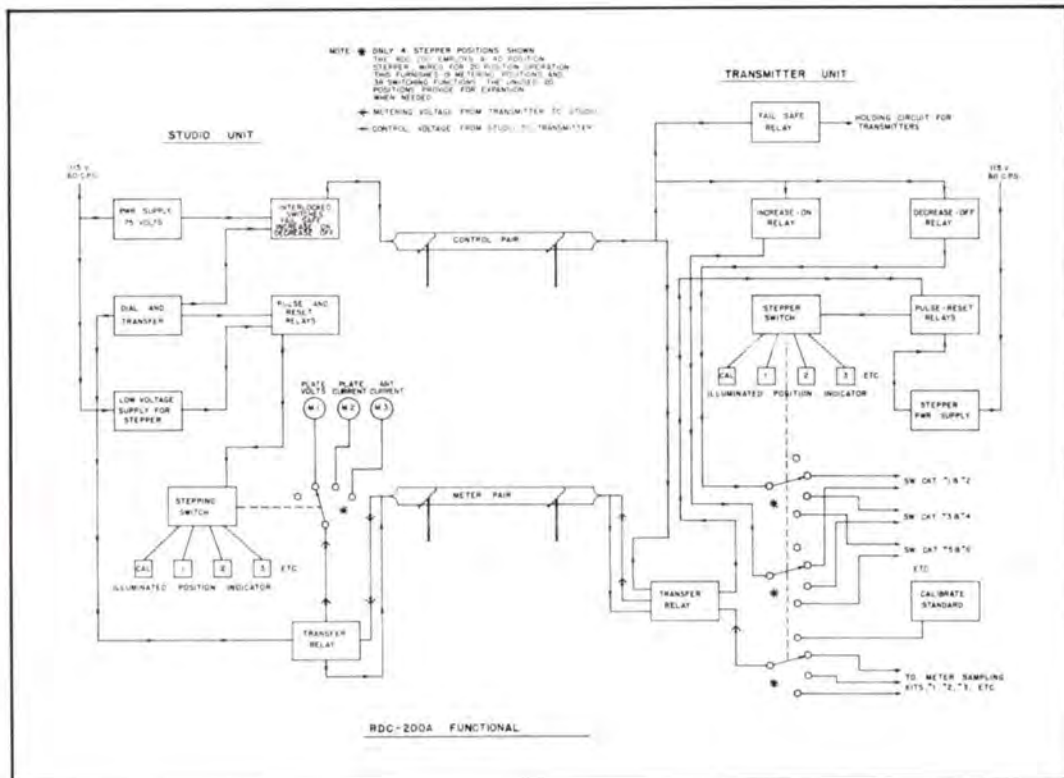

# ACCESSORIES FOR REMOTE CONTROL

## FREQUENCY MONITOR EXTENSION METERS



Used for extending Gates M-2890 monitors. Has 4" frequency indicating meter reading 30-0-30 cycles. Includes resistor pad for sampling voltage. Tubes: 6AW6, 6AQ5, 6AL5, 6X4 and OA2. For 115 volts, 50/60 cycles. Size: 7"x19"x7" deep.

Frequency monitor extension unit ..... M-5270  
 FOR M-4990 FREQUENCY MONITOR  
 Meter is exact duplicate of the M-4990 monitor for extending frequency indication to studios.  
 Extension meter ..... M-5631

## NEW M-5936 AUTOMATIC SEQUENCE SWITCHER

This new unit is for use where station changes power, directional antenna pattern or both. One press of the button performs one function — removing plate voltage, switching, and restoring plate voltage on "off" or "lower" pulse from remote control unit. Another press will restore the original operating condition. These two functions can't be accomplished by continuous pressure on button and, therefore, foolproof switching is assured. Each complete cycle requires exactly one second. Switching cycle is positive since an opposite pulse is necessary to cause the second, or reverse, sequence.

VOLTAGE: 15 A.C. amps at 125, 250, 460 volts.  
 SIZE: Approximately 12" wide, 5" deep, 7" high.  
 WEIGHT: Approximately 10 lbs.  
 Automatic Sequence Switcher ..... M-5936

## RF AMPLIFIER M-5144A

Preferred method is to have frequency and modulation monitors at the studios. This unit picks up the off air signal, furnishes both modulated and unmodulated signal to Gates, GR or RCA frequency and modulation monitors. Includes audio output and carrier failure relay to operate external alarm. Power supply is self-contained. Supplied with complete antenna kit.

TUBES: (3) 6AU6, (2) 6BA6, (1) 1614, (1) 5V4G, (1) 6080, (1) OD5.

POWER: 115 volts, 50/60 cycles, 95 watts.

SIZE: 8 3/4" x 19" x 8" deep. Finish: Gray.

RF Amplifier with tubes ..... M-5144A



## MOTOR OPERATED RHEOSTAT

Recommended for regulating the plate voltage in transmitters of 1 KW and less. Available in three sizes for 250, 500 and 1000 watt transmitters. Motor is one RPM and operates from 115 volts, 60 cycles.

Motor Rheostat for 250 watts ..... M-4703A  
 Motor Rheostat for 500 watts ..... M-4703B  
 Motor Rheostat for 1 kw ..... M-4703C



## TUNING MOTOR

This unit for tuning variable inductor, capacitor or other controls, has inbuilt limit switches. Five wire reversible motor 1 RPM. Requires M-5806 relay assembly for control. 115 volts, 50/60 cycles.  
 Tuning Motor ..... M-5066

## TOWER LIGHT UNIT

This unit is used to provide a DC voltage for indication of proper tower light operation. Includes current transformer.

Tower Light Metering Kit ..... M-5145

## MONITOR EXTENSION METERS



Several types available as listed below for extending both frequency and modulation monitors. Mounted on standard 19" rack panel 5 1/4" high.

Remote meter and panel for Gates M-4990 frequency monitor ..... M-5631  
 Remote meter for extending Gates M-5693 modulation monitor ..... M-5837  
 For extending Gates MO-2639 modulation monitor ..... M-5210  
 For GR1931A or RCA WM43A monitors M-5206  
 For GR1181A or RCA WF48A monitors M-5208  
 For RCA 66 Series monitors ..... M-5207  
 For RCA 311A monitor ..... M-5209

## ANTENNA DIODE UNIT



The antenna diode unit is designed to provide remote metering of antenna current. A DC voltage proportional to the antenna current is returned to the studio unit via the metering line and measured on the directly calibrated antenna current meter. The unit pictured is the M-3759 for use with powers of 1 kw and under. A similar unit, the M-2765B is available for powers in excess of 1 kw. Tube: one type 6H6. Power requirements: 115 volts, 60 cycles.

Diode 1 kw or less ..... M-3759  
 Diode 5 kw or more ..... M-2765B

## RELAY ASSEMBLY

For controlling motors. Usually used where transmitters already incorporate tuning motors. Used with M-5066 tuning motor. As listed below, designed for control of one 3-wire motor or one 5-wire motor.



For 1 3-wire motor ..... M-4801  
 For 1 5-wire motor ..... M-4806

## AUXILIARY RELAY ASSEMBLY

Auxiliary relay assembly to provide one on-off holding switching facility. These relays provide two sets of double throw double contacts rated at 8 amperes.



Auxiliary relay assembly ..... M-5249  
 Same as above but latching (holding) type with 5 ampere contacts ..... M-5248

## PLATE VOLTAGE UNIT

Supplied with all Gates Remote Control Systems. One unit is used with voltages up to and including 6000 volts. For higher voltages, additional units may be connected in series. Also available as an accessory item for metering additional stages or transmitters.  
 Plate Voltage Unit ..... M-4719A

## OUTPUT LOADING CONTROL KIT

Complete kit to control output loading of Gates BC-5P2 5 kw transmitter. It includes M-5066 and M-4806 relay and all necessary mounting hardware.  
 Output Loading Control Kit ..... M-4848A

## RF FM AMPLIFIER M-4791



Operates with any approved, FM frequency/modulation monitor where the signal is taken off the air and monitor is at studio. Amplifier supplied fixed tuned to your frequency. Power supply is not supplied. Requires 300 volts DC at 100 MA and 6.3 volts AC at 3 amperes.

SIZE: 7" x 19" x 8" deep.  
 TUBES: 6AK5, 6BA6, 6AH6, 2E26, OA2.  
 RF FM Amplifier with tubes ..... M-4791

## FM OUTPUT INDICATOR

Designed to sample the 51.5 ohm transmission line of an FM transmitter for measuring transmitter output as required by FCC. Provides a DC voltage which is measured on the studio unit metering system.



FM Output Indicator ..... M-4845

## OVERLOAD RELAY

Replaces circuit breakers in current or older models as circuit breakers are usually undependable for remote control. Tripping current adjustable. Inserted in cathode circuit of RF power amplifier. Some engineers prefer an additional unit in modulator circuit.  
 Overload Relay... M-5129



## AC RECTIFIER

Rectifies the AC voltage, either line or filament, at the transmitter and feeds back DC to studio unit for measuring AC by remote control.  
 AC Voltage Unit ..... M-4825



## PLATE CURRENT UNIT

Included with the Gates Remote Control System. Furnishes a sample of plate current which is returned to the studio unit and measured on the directly calibrated plate current meter. The unit is provided with a high voltage fuse, for personnel and line protection, and can be used for current ranges of .8 ampere and 3 amperes. Can be used with unit furnished with equipment when extended range is necessary.  
 Plate Current Unit ..... M-4720A

## TUNING MOTOR ASSEMBLY

For operating rheostat, variable condenser, or any variable control. Three wire reversible motor 1 RPM. Torque 15 lb. inches, 115 volts, 50/60 cycles.  
 Tuning Motor ..... M-4800

## SPECIAL EQUIPMENT FOR REMOTE CONTROL

Gates has made every effort to provide a complete line of equipment for unattended operation. It is recognized that unusual situations may demand special accessories. Gates engineers will happily work with our customers on any special application.

# DUMMY ANTENNAS

## VHF 5KW DUMMY ANTENNA (heat exchanger)



Self-contained, water cooled 5KW antenna to operate up to 5KW power and up to 500 Mc. Impedance 51 ohms. Consists of 1 HP electric motor driven pump and fan which cools water circulating through radiator to dummy antenna. Overflow reservoir provided. For testing high frequency transmitter in VHF and UHF bands. Has direct reading power indicating watt meter. SIZE: 25" wide, 39½" deep, 36" high. POWER: 5KW continuous at 500 Mc (half rating if AM modulated). RADIATOR: 18 quarts water or approved anti-freeze. COOLING: 900 BTU.



### VHF Dummy Antenna ..... M-5508

NOTE: Other higher power rating heat exchangers are available on special order. Prompt quotations on receipt of (a) power rating, (b) impedance, and (c) frequency of operation.

## AIR COOLED 1KW DUMMY ANTENNA



This unit may be used for any transmitter between 200 Kc and 6 Mc at a maximum power rating of 1KW, 100% modulated. Consists of non-inductive resistors heavily banded together to arrive at correct load resistance. Size 20¼" x 12⅝" x 5" high. Dummy Antenna, 51 ohms ....DU-151  
Dummy Antenna, 70 ohms ....DU-170

## AIR COOLED 5KW DUMMY ANTENNA



Though designed primarily as a dummy antenna for testing 5KW broadcast transmitters, this unit may be used between 200 Kc and 6 Mc with excellent results. Includes series of wire-wound non-inductive resistance elements. Power rating based on 100% modulation at 5KW. Fully housed as illustrated. Size: 27½" x 26" x 10¼" high.

Dummy Antenna, 51 ohms ....DU-551  
Dummy Antenna, 70 ohms ....DU-570

## 50KW AIR COOLED DUMMY ANTENNA

To eliminate water cooling at higher powers, Gates has developed this new air cooled unit for use between 540 and 2000 Kc. As dummy antennas are required in various resistances and loading requirements, this product is carried as a custom item. Gates will quote promptly on receipt of (a) resistance or impedance, (b) distance of dummy antenna from transmitter output, (c) frequency of operation, and (d) cooling facilities, if any. Unit pictured above illustrates the grouping of resistance elements and an aluminum frame. This frame is then installed in a forced air chamber, usually a metal duct with proper size blower attached at one end. In 50KW transmitters with external blower, such as the Gates BC-50B transmitter, the dummy may be mounted in the air duct itself.

A power rating of 75KW permits 100% modulation of 50KW transmitters under proper cooling conditions.

## WATER COOLED DUMMY ANTENNAS



Available in 25KW and 50KW designs for broadcast and high frequency service. Ratings are at 100% amplitude modulation and 50% may be added where unmodulated. — High frequency models are provided with variable coil and variable capacitor elements for tuning out reactance. Medium frequency models are straight resistance elements.

Paralleled wire resistance elements are precision supported in a water-tight glass enclosure around which filtered water is evenly distributed. Dual thermometers measure water temperature in and out and the differential is measured in power.

### SPECIFICATIONS

WATER FLOW: (50KW) 15 gal. per min.  
(25KW) 12 gal. per min.  
LOAD RESISTANCE: Available in 50, 70, 150, 300 and 600 ohms, as ordered. High frequency models available 300 and 600 ohms only.  
SIZE: 78" high, 42" wide, 48½" deep.

### ORDERING INFORMATION

25KW model, 540-1600 Kc ..... M-4750A  
25KW model, 2-25 Mc ..... M-4750  
50KW model, 540-1600 Kc ..... M-5497  
50KW model, 2-25 Mc ..... M-5497A

Above models built to order. Be sure and state power rating and frequency when ordering.

## VHF 10-WATT DUMMY



Designed for measuring BF-E-10B transmitter, listed on Page 56. Power rating 10 watts at 50-250 Mc. Has Type N connector for attaching RG-8U cable. Ideal for measuring low powered VHF transmitters including many types of police transmitters, etc. Impedance 50 ohms.

VHF Dummy Antenna ..... M-5645

# TRANSFORMERS FOR BROADCASTING



These quality transformers are for radio broadcasting, communications and in many instances, television transmitters are regularly carried in stock and are of such specialized design they will not be found elsewhere. If you are modernizing, building your own or need a replacement transformer, you need not wait for it to be specially built as the Gates stock is in most cases immediately available.

## Transformers for 250 Watts

**MODULATION TRANSFORMER:** Primary for PP Class B, 810 tubes. Secondary 4000 ohms no current in Sec. Response 30-10,000 cycles  $\pm 1$  db. Fully cased, 7 $\frac{1}{4}$ " high, 6 $\frac{1}{8}$ " wide, 5 $\frac{1}{4}$ " deep BM-1  
**MODULATION REACTOR:** For use with modulation, transformer BM-1 above. Inductance 65 hy. Current 250 MA  $\pm 1$  db, 30-10,000 cycle response. Fully cased. Size matches BM-1. .... BR-1  
**DRIVER TRANSFORMER:** Primary PP 6L6, 1622, etc. Secondary Class B, 810 tube grids. Chassis mounting, fully cased. Response  $\pm 1$  db, 30-10,000 cycles. .... BD-1  
**POWER TRANSFORMER:** Primary 215/230/245 volts, 50/60 cycles. Secondary 1700-0-1700 volts at .6 amperes continuous duty 3% regulation under Class B modulation. Case Style M. AP-7235  
**SWINGING CHOKE:** 5-25 hy. at 500 MA. 52 ohms resistance. 7000V insulation. Round case, base terminals. .... CG-109  
**SMOOTHING CHOKE:** 25 hy. at 300 MA. 90 ohms resistance. 5000V insulation. Round case, base terminals. .... CG-105

## Transformers for 500 Watts

**MODULATION TRANSFORMER:** Primary for PP Class B, 833A tubes. Secondary 6400 ohms no current in Sec. Response  $\pm 1$  db, 30-10,000 cycles. Case Style M. .... AM-30613  
**MODULATION REACTOR:** For use with above modulation transformer. 50 hy. at 350 MA. 225 ohms resistance.  $\pm 1$  db, 30-10,000 cycles. Case Style M. .... AC-10650  
**DRIVER TRANSFORMER:** For PP 845 tubes or similar Class A to PP 833A Class B grids.  $\pm 1$  db, 30-10,000 cycles. Chassis mount. .... AS-3172C  
**POWER TRANSFORMER:** Primary 230 volts, 50/60 cycles. Secondary 2335-0-2335 volts at 0.46 amperes continuous duty to deliver 2000 volts at 650 MA choke input. Case Style M. .... AP-12001E  
**SWINGING CHOKE:** 5-25 hy. at 500 MA. 52 ohms resistance. 7000V insulation. Round case, base terminals. .... CG-109  
**SMOOTHING CHOKE:** 25 hy. at 300 MA. 90 ohms resistance. 5000V insulation. Round case, base terminals. .... CG-105

## Transformers for 1000 Watts

**MODULATION TRANSFORMER:** Primary for PP 833A in Class B. Secondary 4750 ohms no current in Sec. Also has a second tapped secondary to provide 2, 4 or 8 watts at 3000 ohms for modulating the RF driver stage, if desired.  $\pm 1$  db, 30-10,000 cycles. Case Style M. .... AM-30469  
**MODULATION REACTOR:** For use with AM30469 modulation transformer. Inductance 40 hy. Resistance 170 ohms. Current 600 MA. Response  $\pm 1$  db, 30-10,000 cycles. Case Style M. .... AC-10465  
**DRIVER TRANSFORMER:** For PP 845 tubes or similar in Class A to PP 833A tubes Class B.  $\pm 1$  db, 30-10,000 cycles. Chassis mount. .... AS-3172C

**POWER TRANSFORMER:** Primary 230 volts, 50/60 cycles. Secondary 3100-0-3100 volts at 0.71 amperes to produce 2600 volts DC at 1 ampere when used with choke input filter. Case Style M. .... AP-10459E  
**SWINGING CHOKE:** High inductance, high current type, 5-16 hy. at 1.5 amperes. Resistance 30 ohms. 10,000V insulation. Case Style M. .... AC-10458  
**SMOOTHING CHOKE:** 2 $\frac{1}{2}$  hy. at 700 MA. 20 ohms resistance. 10,000V insulation. Case Style O. .... AC-10457

## Transformers for 5000 Watts

**MODULATION TRANSFORMER:** Primary for PP Class B 3X2500A3 or 3X2500F3 tubes. Secondary 3600 ohms.  $\pm 1$  db, 30-10,000 cycles. Dry type. Case Style M. .... AM-7718E  
**MODULATION TRANSFORMER:** Same specifications as AM-7718E above, only oil filled indoor or outdoor type in steel tank. Case Style N. .... AM-7718M  
**MODULATION REACTOR:** 30 hy. at 1.4 amperes. Response  $\pm 1$  db, 30-10,000 cycles. Insulation 15,000V. Dry type. Case Style M. Companion to modulation transformer AM-7718E. .... AC-7719E  
**MODULATION REACTOR:** Oil filled type in steel tank for indoor or outdoor mounting. 52 hy. at 1.4 amperes. Case Style N. Companion to modulation transformer AM-7718M. .... AC-7719M  
**POWER TRANSFORMER:** Primary 205/215/230 volts, 50/60 cycles, 3 phase delta. Secondary 2160 volts per leg Y connected. Supplies 5000 volts DC at 2.3 amperes when used with six 8008 or 872A rectifier tubes. Dry type. Case Style M. Companion to AM-7718E and AC-7719E. .... AP-8000E  
**POWER TRANSFORMER:** Primary 230 volts, 50/60 cycles, 3 phase delta. Secondary 2160 volts per leg Y connected to deliver 5000 volts DC at 2.3 amperes when used with six 8008 or 872A rectifiers. Oil filled type in steel tank for indoor or outdoor mounting. Case Style N. Companion to AM-7718M and AC-7719M. .... AP-8000M  
**INPUT OR SMOOTHING CHOKE:** 4 hy. at 1.5 amperes. 17 ohms resistance. 8000V insulation RMS. Case Style M. .... AC-3143E  
**DRIVER TRANSFORMER:** For PP parallel 845 tubes or similar Class A to PP 3X2500A3 or 3X2500F3 grids Class B,  $\pm 1$  db, 30-10,000 cycles. Chassis mount. Balance windings for individual biasing of 3X2500 grids. .... AS-3172C

## Transformers for 10,000 Watts

**MODULATION TRANSFORMER:** Primary for PP 3X2500A3 or 3X2500F3 tubes Class B. Secondary 1780 ohms.  $\pm 1$  db, 30-10,000 cycles. Dry type. Case Style M. .... AM-30643E  
**MODULATION TRANSFORMER:** Same specifications as AM-30643E, only oil filled in steel tank for indoor or outdoor mounting. Case Style N. .... AM-32886  
**MODULATION REACTOR:** 26 hy. at 2.8 amperes  $\pm 1$  db, 30-10,000 cycles. Dry type. Case Style M. Companion to AM-30643E. .... AC-3168E

## TRANSFORMERS FOR BROADCASTING

### TRANSFORMERS (continued)

**MODULATION REACTOR:** Same as AC-3168E, only oil filled in steel tank for indoor or outdoor service. Case Style N. Companion to modulation transformer AM-3167M. AC-32887

**DRIVER TRANSFORMER:** For PP parallel 845 tubes or similar Class A to PP 3X2500A3 or 3X2500F3 grids Class B.  $\pm 1$  db, 30-10,000 cycles. Chassis mount. Balanced windings for individual bias of 3X2500 tubes. AS-3172C

**POWER TRANSFORMER:** Primary 230 volts, 50/60 cycles, 3 phase delta. Secondary tapped to deliver 5000, 5250 or 5500 volts DC at 4.5 amperes when used with six 673 tubes Y connected. Dry type. Case Style P. Companion to AM-3167E and AC-3168E. AP-3090E

**POWER TRANSFORMER:** Same as above, only oil filled in steel tank for indoor and outdoor mounting. Case Style N. Companion for AM-3167M and AC-3168M. AP-3090M

**INPUT OR SMOOTHING CHOKE:** 2 hy. at 3 amperes. 6.4 ohms resistance, 18,000 volt insulation. Case Style M. in 10KW broadcast, 2 chokes are used as input chokes for RF and modulators. AC-3147E

### Transformers for 20KW

**MODULATION TRANSFORMER:** Primary for four 3X3000A1 or 3X3000F1 tubes in PP parallel, impedance 5000 ohms plate to plate. Secondary 935 ohms to match Class C amplifier of four 3X2500A3 or 3X2500F3 tubes.  $\pm 1$  db, 30-10,000 cycles. Oil filled indoor or outdoor type. Case Style N. Use with modulation reactor AC-8675M and driver transformer AS-8672E listed below. AM-8674M

**MODULATION REACTOR:** 14 hy. at 5.25 amperes.  $\pm 1$  db, 30-10,000 cycles. Oil filled indoor or outdoor type. Case Style N. Use with AM-8674M modulation transformer and 8 mfd. coupling capacitor. AC-8675M

**DRIVER TRANSFORMER:** Primary two 845 tubes or similar in Class A. Secondary two windings for Class B grids of four 3X3000A1 or 3X3000F1 tubes in PP parallel,  $\pm 1$  db, 30-10,000 cycles. Chassis mount. AS-8672E

**POWER TRANSFORMER:** Suggest separate power supplies for modulators and RF, using two Type AP-3090M power transformers as listed above under 10KW transformers.

**FILTER REACTOR:** 2 hy. at 5.3 amperes. Oil filled indoor or outdoor mounting. For 20KW two used for dual power supplies as suggested above under "Power Transformer." Case Style N. AC-8673M

### Transformers for 50KW

**MODULATION TRANSFORMER:** Primary 3300 ohms plate to plate for two 5891 tubes, Class B, with 10.7 KV on plates. Secondary 1700 ohms. Oil filled in steel tank for indoor or outdoor service.  $\pm 2$  db, 30-10,000 cycles. Case Style A. Size: 33" wide, 42" deep, 58" high. AM-11788

**MODULATION REACTOR:** For use with AM-11788 above. 25 hy. at 6.5 amperes. 7600 volts RAS at 30 cycles.  $\pm 2$  db, 30-10,000 cycles. Oil filled in steel case for indoor or outdoor mounting. Size: 40" diameter. 56" high. Case Style O. AC-11787

**DRIVER TRANSFORMER:** A cathode follower circuit is recommended for this service employing four type 833A driver tubes. Circuit information will be supplied to purchasers of AM-11788 and AC-11787 units where requested.

**POWER TRANSFORMER:** Primary 460 volts single phase, 50/60 cycles. 3 required for 3 phase delta primary and secondary. Primary has 2 1/2% taps above and below 460V and tap for low power. Secondary 8300-4150 volts. When used with 3 phase full wave bridge rectifier, filter reactor AC-11786 below and six type

857B rectifier tube will deliver, 10,700 volts DC at 13 amperes. Case Style C. Oil filled indoor or outdoor mounting. Size: 27" diameter, 56" high. AP-11785M

**FILTER REACTOR:** 1 hy. at 13 amperes, 34,000 volt test insulation. Oil filled in steel tank for indoor or outdoor mounting. Case Style D. AC-11786

### Filament Transformers

**FOR SINGLE 3X2500A3 or 3X2500F3.** Primary 215/230/245 volts, 50/60 cycles. Secondary 7.8 VCT 51 ampere. Case Style R. AF-7782E

**FOR THREE 3X2500A3 or 3X2500F3.** Primary 215/230/245 volts, 50/60 cycles. Three separate 7.8 VCT 51 ampere secondaries. Case Style R. AF-10434E

**FOR 5891 TUBE IN 50KW SERVICE.** Three required for 3 phase. Primary 230 volts, single phase, 50/60 cycles with  $\pm 2 1/2\%$  taps. Secondary 11 volts at 95 amperes. Primaries are delta connected and secondaries Y connected. Size: 6 1/4" wide, 9 7/8" high, 7 7/8" deep. AF-11856E

**FOR FOUR 833A OR SIMILAR TUBES.** Primary 230 volts, 50/60 cycles. Secondary No. 1, 10 VCT at 10 amperes. Secondary No. 2, 10 VCT at 10 amperes. Secondary No. 3, 10 VCT at 20 amperes. Has heavy wire leads for direct connection to tube sockets. Case Style R. AF-30099E

**RECTIFIER FILAMENT TRANSFORMER.** Has 6 secondary windings 5 VCT at 10 amperes for 8008, 872A or 673 rectifier tubes. Primary 215/230/245 volts single phase, 50/60 cycles. Used as rectifier filament transformer in 5, 10 and 20KW transmitters. Insulation 15,000 volts. Case Style R. AF-10432E

**RECTIFIER FILAMENT TRANSFORMER.** Primary 230 volts, 50/60 cycles. Secondary 5.1 VCT at 15 amperes for two 8008 or 872A rectifier tubes. Insulation 10,000 volts. AF-10456K

**RECTIFIER FILAMENT TRANSFORMER.** For 857B rectifier filament as used in 50KW service. Primary 230 volts, 50/60 cycles with  $\pm 2 1/2\%$  taps. Secondary 5 volts at 33 amperes. Insulation all points 25,000 volts. Size: 6" wide, 3 7/8" deep, 8" high. AF-11857E

### Audio Transformers

**INPUT TRANSFORMERS:** For transmitter input to low level audio stages. Handles +20 db input or less at low distortion. Quadruple shielding. Round case chassis mount.  $\pm 1$  db, 30-15,000 cycles. Primary 125/250 or 500/600 ohms. Secondary for PP or single grid 120,000 ohms. AI-3002U

**INPUT TRANSFORMER:** Specifically designed for high quality preamplifier input. Triple shielding. Round case. Primary 50/150/250 ohms. Secondary to single 60,000 ohm grid. 1 3/4" diameter and 1 5/16" high. Maximum input level 0 db,  $\pm 1/2$  db, 30-15,000 cycles. AI-10379T

**INPUT TRANSFORMER:** Identical to AI-10379T above, only primary 600 ohms. AI-10386T

**OUTPUT TRANSFORMER:** Preamplifier output transformer to match AI-10379T or AI-10386T input transformers. Primary 15,000 ohms, no DC in winding. Secondary 150/250 and 600 ohms. Excellent shielding. Size: 1" diameter and 1 3/16" high.  $\pm 1/2$  db, 30-15,000 cycles. AO-10427T

**OUTPUT TRANSFORMER:** For program or remote amplifiers. Primary 10,000 ohms with up to 15 MA in winding. Secondary 150/250 and 600 ohms. Excellent shielding. Size: 2" wide, 1 3/4" deep, 2 3/4" high.  $\pm 1$  db, 30-15,000 cycles. AO-10864T

**REPEATER TRANSFORMER:** Line to line. Primary and secondary 50/125/250/500 and 600 ohms. Maximum level +16 db. Response 20-20,000 cycles  $\pm 1$  db. Fully cased top or chassis mounting. 114A

### 50,000 TRANSFORMERS

Listed on these pages is only a fraction of the huge transformer stock in the Gates stock rooms. If you have a breakdown, call the Gates service department first. If you need a special, it is likely Gates will have it. From the smallest ounce weight unit to 50 KW, be it audio, filter, power, equalizer, autoformer or filament transformers, the 50,000 transformer stock is the largest in the world geared to broadcaster and communications needs.

# INDUCTORS, VARIABLE AND FIXED

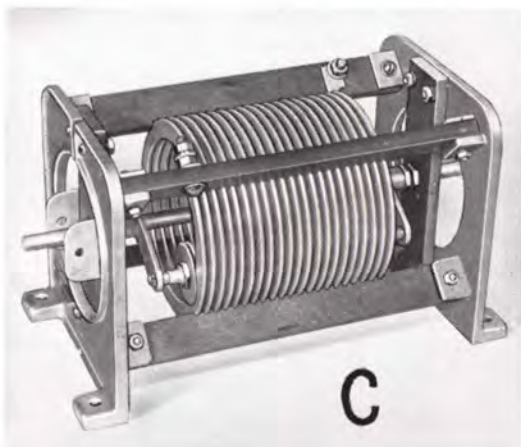
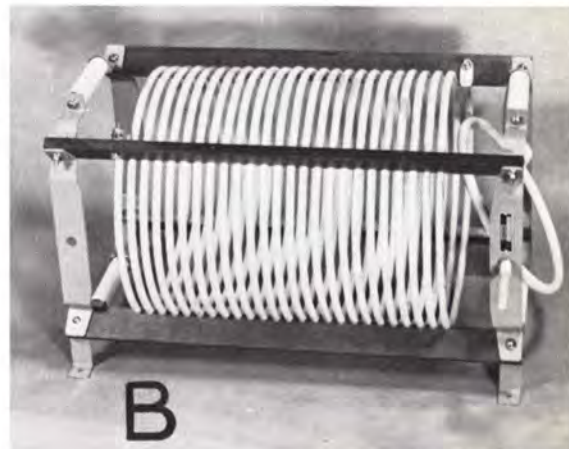
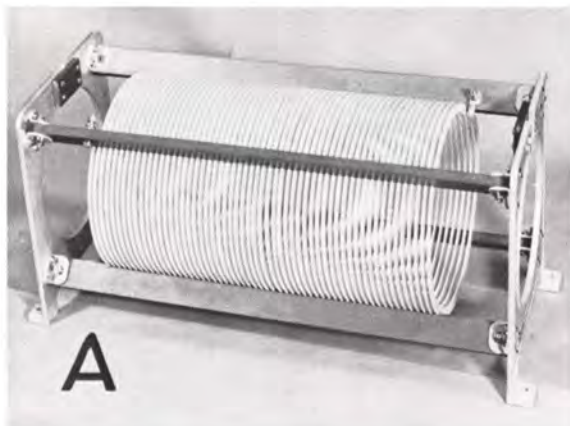

Used in both Gates and many other makes of transmitters and phasing equipment. Variable coils have cast aluminum end bells with double gripping bearing wheels. All types are micalex insulated and silver plated and have the highest possible "Q's".

**LEGEND:**

- FA— Fixed 1/4" edgewise, 10 amp. rating, Fig. A
- FB— Fixed 3/8" edgewise, 15 amp. rating, Fig. A
- FC— Fixed 1/2" edgewise, 20 amp. rating, Fig. A
- FBT— Fixed 3/8" copper tubing, 30 amp. rating, Fig. B
- FCT— Fixed 1/2" copper tubing, 40 amp. rating, Fig. B
- VB— Variable 3/8" edgewise, 15 amp. rating, Fig. C
- VC— Variable 1/2" edgewise, 20 amp. rating, Fig. C

Ind. uh	Length	Diam.	Cat. No.	Ind. uh	Length	Diam.	Cat. No.
87	12 1/16"	4"	87FA4634	17	8 3/4"	4"	17FC1654
6	5 15/16"	4"	6FBO854	24	8 3/4"	5"	24FC1655
10	5 15/16"	5"	10FBO855	32	8 3/4"	6"	32FC1656
13	5 15/16"	6"	13FBO856	42	12 5/8"	6"	42FC2266
18	8 3/4"	4"	18FB1754	67	13 1/16"	6"	67FC2856
26	8 3/4"	5"	26FB1755	78	16"	8"	78FC2568
35	8 3/4"	6"	35FB1756	10	12 1/2"	6"	10FBT1066
58	10 3/8"	5"	58FB2845	32	15"	8"	32FBT1658
78	10 3/8"	6"	78FB2846	45	18 1/2"	8"	45FBT2158
128	12 1/8"	5"	128FB4635	65	24 1/2"	9"	65FBT2559-C
6	6 1/4"	4"	6FC0854	17	14"	8"	17FCT1178
10	6 1/4"	5"	10FC0855	35	24 1/2"	9"	35FCT1779-C
13	6 1/4"	6"	13FC0856				



**VARIABLE COILS**

Ind. uh	Length	Diam.	Cat. No.	Ind. uh	Length	Diam.	Cat. No.
6	8"	4"	6VC0854	16	9 1/8"	4"	16VB1544
15	10 3/4"	4"	15VC1444	30	11 1/8"	4"	30VB2344
26	10 3/4"	4"	26VC2144	105	12 1/2"	5"	105VB3735

**CLIPS**

- LC4 For 1/4" edgewise FA coils
- LC6 For 3/8" edgewise FB coils
- LC8 For 1/2" edgewise FC coils
- RC6 For 3/8" tubing FBT coils
- RC8 For 1/2" tubing FCT coils

**DIAL FOR VARIABLE COIL**

- M3401F Veeder counter geared type, reads to 1/10 turn. 1/4" diam. shaft. Fig. D.
- M5521 Veeder counter geared type, reads to 1/10" turn. 3/8" diam. shaft.



# MICA AND FILTER CAPACITORS



### Type F2 Mica Capacitors

Part Number	Capacity Mfd.	Peak Wkg. Volts
F2-545	.00005	5000
F2-531	.0001	5000
F2-5315	.00015	5000
F2-532	.0002	5000
F2-5325	.00025	5000
F2-533	.0003	5000
F2-534	.0004	5000
F2-535	.0005	5000
F2-536	.0006	5000
F2-5375	.00075	5000
F2-538	.0008	5000
F2-521	.001	5000
F2-5215	.0015	5000
F2-522	.002	5000
F2-5225	.0025	5000
F2-523	.003	5000
F2-424	.004	4000
F2-325	.005	3000
F2-326	.006	3000
F2-328	.008	3000
F2-211	.01	2000
F2-2115	.015	2000
F2-212	.02	2000
F2-213	.03	2000
F2-1514	.04	1500
F2-1515	.05	1500
F2-0501	.1	500
F2-0202	.2	250
F2-02025	.25	250

Type	Capacity
7106-2	2— 600 volts DC
7106-4	4— 600 volts DC
7106-8	8— 600 volts DC
7106-10	10— 600 volts DC
7110-2	2—1000 volts DC
7110-4	4—1000 volts DC
7110-8	8—1000 volts DC
7110-10	10—1000 volts DC
7120-2	2—2000 volts DC
7120-4	4—2000 volts DC
7120-8	8—2000 volts DC
7120-10	10—2000 volts DC
7130-2	2—3000 volts DC
7130-4	4—3000 volts DC
7130-8	8—3000 volts DC
7140-2	2—4000 volts DC
7140-4	4—4000 volts DC
7140-6	6—4000 volts DC
7150-2	2—5000 volts DC
7150-4	4—5000 volts DC
7160-1	1—6000 volts DC
7160-2	2—6000 volts DC
7175-1	1—7000 volts DC
7175-2	2—7000 volts DC
TK70040	4—7000 volts DC

### TYPE F

Catalog Number	Capacity Mfd.	Peak Wkg. Volts
----------------	---------------	-----------------

### Type G4

G4-3043	.00003	30000
G4-3045	.00005	30000
G4-3031	.0001	30000
G4-30315	.00015	30000
G4-30325	.00025	30000
G4-3035	.0005	30000
G4-3038	.0008	30000
G4-3021	.001	30000
G4-25215	.0015	25000
G4-2022	.002	20000
G4-2023	.003	20000
G4-2024	.004	20000
G4-1525	.005	15000
G4-1526	.006	15000
G4-1228	.008	12000
G4-1011	.01	10000
G4-612	.02	6000
G4-514	.04	5000

### Type G5

G5-5045	.00005	50000
G5-3531	.0001	35000
G5-35325	.00025	35000
G5-3534	.0004	35000
G5-3535	.0005	35000
G5-3521	.001	35000
G5-3022	.002	30000
G5-30225	.0025	30000
G5-3023	.003	30000
G5-2525	.005	25000
G5-2026	.006	20000
G5-1511	.01	15000

### Type F1 Mica Capacitors

F1-341	.00001	3000
F1-345	.00005	3000
F1-331	.0001	3000
F1-3315	.00015	3000
F1-332	.0002	3000
F1-3325	.00025	3000
F1-333	.0003	3000
F1-334	.0004	3000
F1-335	.0005	3000
F1-336	.0006	3000
F1-3375	.00075	3000
F1-338	.0008	3000
F1-321	.001	3000
F1-3215	.0015	3000
F1-322	.002	3000
F1-3225	.0025	3000
F1-223	.003	3000
F1-224	.004	2000
F1-225	.005	2000
F1-226	.006	2000
F1-1528	.008	1500
F1-111	.01	1000
F1-112	.02	1000
F1-10215	.05	250
F1-0201	.1	250

### Type F3 Mica Capacitors

F3-8325	.00025	8000
F3-835	.0005	8000
F3-821	.001	8000
F3-822	.002	8000
F3-825	.005	8000
F3-811	.01	8000
F3-415	.05	4000
F3-201	.1	2000
F3-06025	.25	600
F3-0605	.5	600
F3-0610	1.0	600

### Type E

Catalog Number	Capacity Mfd.	Test Volts D.C.
E-1245	.00005	12500
E-1231	.0001	12500
E-12325	.00025	12500
E-1235	.0005	12500
E-1221	.001	12500
E-12215	.0015	12500
E-1222	.002	12500
E-1023	.003	10000
E-1024	.004	10000
E-1025	.005	10000
E-721	.001	7000
E-722	.002	7000
E-723	.003	7000
E-711	.01	7000
E-3524	.004	3500
E-3525	.005	3500
E-3511	.01	3500
E-3512	.02	3500
E-3515	.05	3500
E-215	.05	2000
E-201	.1	2000



TYPE E



TYPE H

MICA CAPACITORS

### 1200 W.V.D.C.

H-T2450	.00005	\$0.96
H-T2310	.0001	.96
H-T2320	.0002	.96
H-T2325	.00025	.96
H-T2325	.00025	.96
H-T2330	.0003	.96
H-T2340	.0004	.96
H-T2350	.0005	.96
H-T2210	.001	1.08
H-T2215	.0015	1.38
H-T2220	.002	1.44
H-T2225	.0025	1.68
H-T2230	.003	1.83
H-K2240	.004	1.83
H-K2250	.005	1.98
H-K2260	.006	1.98
H-K2280	.008	2.31
H-K2110	.01	3.06

Catalog Number	Capacity Mfd.	Peak Wkg. Volts
----------------	---------------	-----------------

### Type G1

G1-641	.00001	6000
G1-645	.00005	6000
G1-631	.0001	6000
G1-632	.0002	6000
G1-634	.0004	6000
G1-635	.0005	6000
G1-621	.001	6000
G1-6215	.0015	6000
G1-622	.002	6000
G1-623	.003	6000
G1-624	.004	6000
G1-625	.005	6000
G1-526	.006	5000
G1-511	.01	5000
G1-4115	.015	4000
G1-312	.02	3000

### Type G2

G2-1031	.0001	10000
G2-10315	.00015	10000
G2-1032	.0002	10000
G2-10325	.00025	10000
G2-1035	.0005	10000
G2-1021	.001	10000
G2-10212	.0012	10000
G2-10215	.0015	10000
G2-1022	.002	10000
G2-823	.003	8000
G2-824	.004	8000
G2-525	.005	5000
G2-526	.006	5000
G2-511	.01	5000
G2-4115	.015	4000
G2-312	.02	3000

### Type G3

G3-2045	.00005	20000
G3-2031	.0001	20000
G3-2032	.0002	20000
G3-20325	.00025	20000
G3-2033	.0003	20000
G3-2035	.0005	20000
G3-2038	.0008	20000
G3-2021	.001	20000
G3-15215	.0015	15000
G3-1522	.002	15000
G3-1523	.003	15000
G3-1524	.004	15000
G3-1025	.005	10000
G3-1026	.006	10000
G3-1028	.008	10000
G3-1011	.01	10000
G3-512	.02	5000
G3-313	.03	3000

# OPEN WIRE TRANSMISSION LINE



M-3327 Bracket

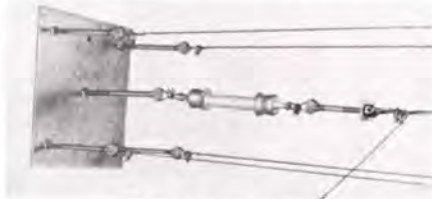

M-3328 End Plate



M-2870D Feed-Thru Bowl



M-3322 Horn Gap



M-3864 Center Post

## Transmission Line Bracket

For 5 or 6 wire transmission line. Rating up to 150KW modulated. Made of 1/4" steel 3" wide with welded L section on each side to fully prevent twisting under ice or wind load. Supplied with 8 1/4" ribbed insulator, wire guides and all hardware. Galvanized throughout.

Line Bracket ..... M-3327

## Line End Plate

To terminate the open wire line at each end, Plate is 1/4" thick, 20" square. Fully galvanized. Includes turnbuckles, 25 1/2" strain insulator and all hardware. Rating up to 150KW modulated.

End Plate ..... M-3328

## Feed-Thru Bowls

A large feed-thru bowl with 50KW modulated rating. Available in single and double units and with solid or hollow studs as listed below. Bowls are Alsimag. Hardware heavy brass. Velutex seals are provided for weather-tight installation.

- Solid stud, 2 bowls, for walls to 10 1/2" thick ..... M-2870D
- Same as above but hollow stud ..... M-3254
- Solid stud, single bowl, for walls 1" thick ..... M-5280
- Same as above but hollow stud ..... M-5281

## Horn Gap

A very desirable item where higher power is employed. Connects to hot side of line and ground to drain off lightning and heavy static discharges. Usually one is employed for each 200' of line. Insulator for 150KW arc gaps heavy chrome plate. Galvanized throughout.

Horn Gap ..... M-3322

## Center Post Assembly

Has variety of uses such as end or corner angling of transmission line, support insulator for two wire line or rhombic antennas, and a guide insulator such as end of building or coupling unit. Rating 150KW galvanized throughout.

Center Post Insulator ..... M-3864

## Hard Drawn Wire

If desired, when ordering transmission line components, Gates will gladly supply No. 6, 8 or 10 hard drawn copper wire of current market prices. State length in feet desired, remembering to multiply the length of line by the number of wires in line, either 5 or 6.

## Special Open Wire Lines

Gates engineers have designed many special open wire lines for both short and long distances. Most celebrated was a 30-mile line supplies for use in the Arctic Circle. Upon receipt of a sketch or word description of the requirements, Gates engineers will gladly submit layout and quotation.

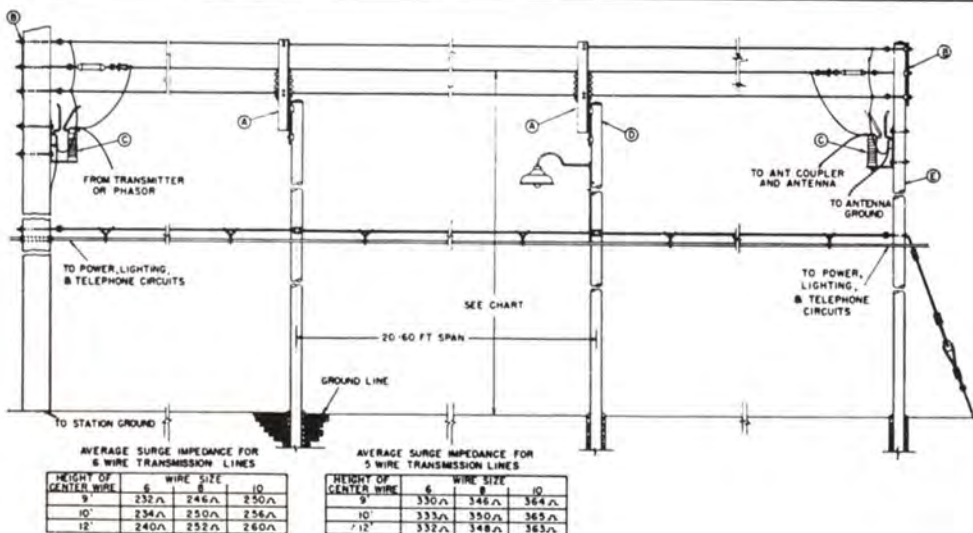

## Open Wire Design and Impedance Chart

Chart to the left illustrates typical five or six wire open type transmission line. Table is provided to show impedances with various wire sizes at certain heights above ground. Transmission line brackets are M-3327, end plate M-3328. Horn gap is M-3322. The power, lighting and telephone circuits shown are optional, according to requirements of installation. Open wire line will average about the same per foot cost as 7/8" coaxial copper cable.

# COAXIAL CABLE, TOWER LIGHTS AND ACCESSORIES

## Solid Dielectric Cable

Low loss, flexible, polyethylene inner jacket covered by copper shield with vinyl outer jacket overall, impervious to exposure, acids, alkalis, oils and gasoline. Excellent AM transmission line.

Item	Cat. No.
SINGLE CONDUCTOR OD .285, impedance 51 ohms....	RG-8U
SINGLE CONDUCTOR OD .285, impedance 75 ohms....	RG-11U
SINGLE CONDUCTOR OD .680, impedance 51 ohms....	RG-17U
SINGLE CONDUCTOR OD .910, impedance 51 ohms....	RG-19U
TWO CONDUCTOR OD .285, impedance 95 ohms.....	RG-22U

RG cable should be ordered to length desired. Where continuous unbroken lengths are required in long sections, a refundable reel charge of \$50.00 per reel will be made and fully credited with reel returned transportation prepaid.

## Heliax 50 Ohm Coaxial Cable

A new type of cable combining high efficiency, ease of handling and low standing wave ratio. High efficiency due to spiral insulation of low loss polyethylene permitting high percentage of air in space between inner and outer conductors. The inside of the outer conductor is clad with heavy conductivity copper. Fully weatherproof and flexible, requiring no elbows, junction boxes etc., for making bends.

COAXIAL CABLE 7/8" diam. Length to order. Specify end fittings desired as listed below and attached at no extra charge .....	H-0
COAXIAL CABLE 1 1/8" diam. Length to order. Specify end fittings desired as listed below and attached at no extra charge .....	H-1
END TERMINAL for 7/8" Heliax line .....	20-T
FLANGE END TERMINAL for 1 1/8" Heliax line .....	21-F

## Air Dielectric Coaxial Cable

Andrew air dielectric coaxial cable has solid copper outer conductor with inner conductor supported by steatite beads.

COAXIAL CABLE 3/8" semi-flexible, impedance 70 ohms .....	83
END TERMINAL FOR 3/8" LINE with gas inlet and pressure gauge .....	1701-GV
END TERMINAL FOR 3/8" LINE with removable exhaust plug .....	1701-P
END TERMINAL FOR 3/8" LINE with needle valve for gas release .....	1701-R
COAXIAL CABLE 7/8" semi-flexible, impedance 50 ohms, power rating for AM broadcast 3.2KW .....	S-450
END TERMINAL FOR S-450 CABLE with gauge and valve .....	1703-AGV
END TERMINAL FOR S-450 CABLE with gas release plug .....	1703-AP
END TERMINAL FOR S-450 CABLE with release valve .....	1703-AR

When ordering S-450 cable, specify end fittings desired as above and these will be attached at the factory and complete assembly shipped under pressure. No charge will be made for this service other than in large lengths, reel will be billed but refunded when returned transportation prepaid.

COAXIAL CABLE 1 1/8" OD, impedance 51.5 ohms, rated 10 KW for AM broadcast, supplied in 20' lengths, includes flanges and fittings for each end .....	451
---	-----

## AIR DIELECTRIC COAXIAL CABLE (continued)

Item	Cat. No.
COAXIAL CABLE, any special length of 451 (state length when ordering) .....	12211
RIGHT ANGLE MITERED ELBOW FOR 451 CABLE, includes flanges and fittings .....	1051-M
45-DEGREE MITERED ELBOW with flanges and fittings for 451 cable .....	1151-M
GAS INLET COUPLING FOR 451 CABLE .....	1351
CLAMP CONNECTOR for providing a pressure type flange on cut end of 451 cable .....	T-1551
END TERMINAL having Type N jack on one end, standard flange for Type 451 cable on order end, incorporates gas barrier and removable gas vent plug .....	13942

## Ground Materials

No. 10 SOFT DRAWN COPPER GROUND WIRE, packed in 100-pound coils, approximately 3100 feet in 100 pounds .....	GR-10
COPPER GROUND STRAP 2" WIDE, packed in 100' rolls .....	GR-2ST
COPPER GROUND STRAP 4" WIDE, packed in 50' rolls .....	GR-4ST
GROUND ROD, Copperweld heavy ground rod 8' long .....	GR-8R
GROUND SCREEN, heavy copper, 3/4" mesh in sheets 8'x24' .....	GR-24SC

The above materials are carried in Quincy and all branches. Prices shown in price list vary as to variance of copper market.

## Pumps, Dehydrators

DRY AIR PUMP comes complete with 8' hose and silica gel fill .....	878
AUTOMATIC DEHYDRATOR used with all sizes air dielectric lines for dehydrating as much as 40,000 feet of 7/8" line, 10,000 feet of 1 1/8" line, etc., wall mount .....	1910
GAS DISTRIBUTION MANIFOLD, includes pressure gauges, needle valves, 15' of 1 1/4" copper tubing for any number of coaxial cables. State number of outlets desired .....	6600

## Tower Lights

SINGLE OBSTRUCTION LIGHT, bottom entrance conduit fitting furnished with lamp receptacle to accommodate either a 100 or 111 watt, 115V medium screw base lamp, or lumen medium pre-focus series lamp .....	OB-20
SINGLE OBSTRUCTION LIGHT, same as Model OB-20 above but side entrance conduit fitting .....	OB-21
DOUBLE OBSTRUCTION LIGHT, provided with two lamp receptacles, each accommodating either 100 or 111 watts, medium screw base lamp, or lumen medium pre-focus lamp. Bottom entrance fitting type for 1" conduit. FOR MEDIUM SCREW BASE .....	OB-22-4
FOR PRE-FOCUS BASE .....	OB-22P-4

(continued next page)

## COAXIAL CABLE, TOWER LIGHTS AND ACCESSORIES

### TOWER LIGHTS (continued)

CODE BEACON 300 MM, standard fully approved FCC and CAA model supplied with two red filters.	
FOR 3/4" CONDUIT .....	KG-114-3
FOR 1" CONDUIT .....	KG-114-1
REPLACEMENT LAMP, 100 WATT OBSTRUCTION	100A21-TS
REPLACEMENT LAMP, 111 WATT OBSTRUCTION	111A21-TS
BEACON LAMP, 500 WATT .....	500PS-40
BEACON LAMP, 620 WATT .....	620PS-40

### Complete Tower Light Kits

The following kits are complete, meeting the requirements of FCC Form 715, FCC Rules Part 17, and CAA standards for marking and lighting obstructions to air navigation, November 1, 1953. The FCC construction permit in all cases will specify the required lighting for each installation, which should tie to the specifications of lighting kits as shown below.

TOWER LIGHTING KIT FOR TOWERS TO 150'. FCC Spec. No. 2, CAA Spec. No. 1, includes one double obstruction light .....	A-1
TOWER LIGHTING KIT FOR TOWERS 151' to 300'. FCC Spec. Nos. 3, 11, 21 and CAA Spec. A-2, includes one code beacon, two obstruction lights, beacon flasher and photo-electric control .....	A-2
TOWER LIGHTING KIT FOR TOWERS 301' to 450'. FCC Spec. Nos. 3, 12, 21 and CAA Spec. A-3, includes code beacon, four obstruction lights, beacon flasher and photo-electric control .....	A-3
TOWER LIGHTING KIT FOR TOWERS 451' to 600'. FCC Spec. Nos. 3, 4, 13, 21 and CAA Spec. A-4, includes two code beacons, six obstruction lights, beacon flasher and photo-electric control .....	A-4

For towers higher than 600' please write for prices. Equipment for tower lighting normally carried in stock at all times.

### Flashers and Photo Cell Units

SINGLE UNIT, indoor housing, lighting control unit with outdoor remote weather photo tube, includes complete code flasher for flashing of three towers and photo-electric cell control for automatic turning on and off 115/230 V, 50/60 cycle, 3 conductors to each tower .....	LC-2077
SINGLE UNIT, indoor housing, same as LC-2077 above but for 4 towers instead of 3 .....	LC-2076
BEACON FLASHER, electro-mechanical device for outdoor mounting, meets FCC and CAA regulations, single pole mercury tilt switch and synchronous motor, Model BF-32 has fail-safe provision for 117 V, single circuit type.	
BEACON FLASHER .....	BF-31
BEACON FLASHER with fail-safe .....	BF-32

*Gates is a national distributor for Andrew, Hughey & Phillips, Fischer-Pierce and other leading manufacturers of approved tower lighting equipment. Generous stocks are carried at the factory and branch.*

For open wire transmission line, see Page 105.

### FLASHERS AND PHOTO CELL UNITS (continued)

PHOTO-CELL AND BEACON FLASHER, a combination unit in weatherproof housing. Photo-cell may be rotated to north regardless of mounting position on tower. Turns on at 35-foot candles and off at 58-foot candles. Fully approved.	
FOR 1 POLE 30 AMPERES, flashes one circuit .....	LC-2074
FOR 1 POLE 30 AMPERES, flashes two circuits .....	LC-2072
FISCHER-PIERCE PHOTO-CELL UNIT, unit completely weatherproof, fully approved for turning on and off tower lights, has time delay of 5-7 seconds to prevent operating lights by chance exposure such as walking in front of unit.	
PHOTO-CELL UNIT for 105-130 volts, 3000 watt rating, SPST, double break .....	63305C
PHOTO-CELL UNIT, same as above but for 210-250 volts .....	63306C

### Rhombic Antenna Equipment

RHOMBIC TRANSMITTING ANTENNA, frequency range 4-22 Mcs., power 30 KW. A 3-wire curtain. Kit consists of 3-strand No. 12 Copperweld wire with maximum side lengths of 375'. Strain and spreader insulators with necessary hardware included for tower or pole attachment. Downlead is supplied with transmission line kit (see RTL-300 below). Shipping weight: 500 lbs.	
RHOMBIC TRANSMISSION ANTENNA .....	RTA-300
TRANSMISSION LINE FOR RHOMBIC ANTENNA, a 500' 2-wire open-wire line having a nominal impedance of 600 ohms, with 3-strand No. 12 Copperweld wire spaced 12" apart, includes downlead for rhombic transmitting antenna (RTA-330 above), strain insulators, line support insulators for single pole mounting, horn gap insulators, with grounding wire and rods, improved entrance bowls, wooden crossarms (2) for dead ending, guys and anchors for one dead end and three line-turn poles, all with necessary hardware. Shipping weight: 400 lbs.	
TRANSMISSION LINE FOR RHOMBIC ANTENNA .....	RTL-300
DISSIPATION LINE FOR RHOMBIC TRANSMITTING ANTENNA, includes 1500' of No. 14 stainless steel wire, strain spreader and spacer insulators, line tension and equalization sheaves, ground wire and rod, one cross-arm with pole guy and anchor for dead ending below antenna, and all necessary hardware. Shipping weight: 125 lbs.	
DISSIPATION LINE .....	TDL-340
DOUBLET TRANSMITTING ANTENNA, frequency range 2-15 Mcs., power 30 KW, consists of 7-strand No. 12 Copperweld wire, includes strain insulators and hardware for Attaching to towers or poles. Downlead included in kit listed below. Shipping weight: 90 lbs.	
DOUBLET ANTENNA .....	DTA-430
TRANSMISSION LINE FOR DOUBLET TRANSMITTING ANTENNA, 500' long, 2-wire, 600 ohm, open-wire line consists of 3-strand No. 12 Copperweld for downlead (delta match type) and line, dead end cross-arms, strain line support and improved entrance bowl insulators, horn gap insulators with ground wire and rod, pole guys and anchors for dead end poles and line-turn poles, and necessary hardware. Shipping weight: 360 lbs.	
TRANSMISSION LINE FOR DOUBLET ANTENNA .....	DTL-400

# UTILITY TOWERS

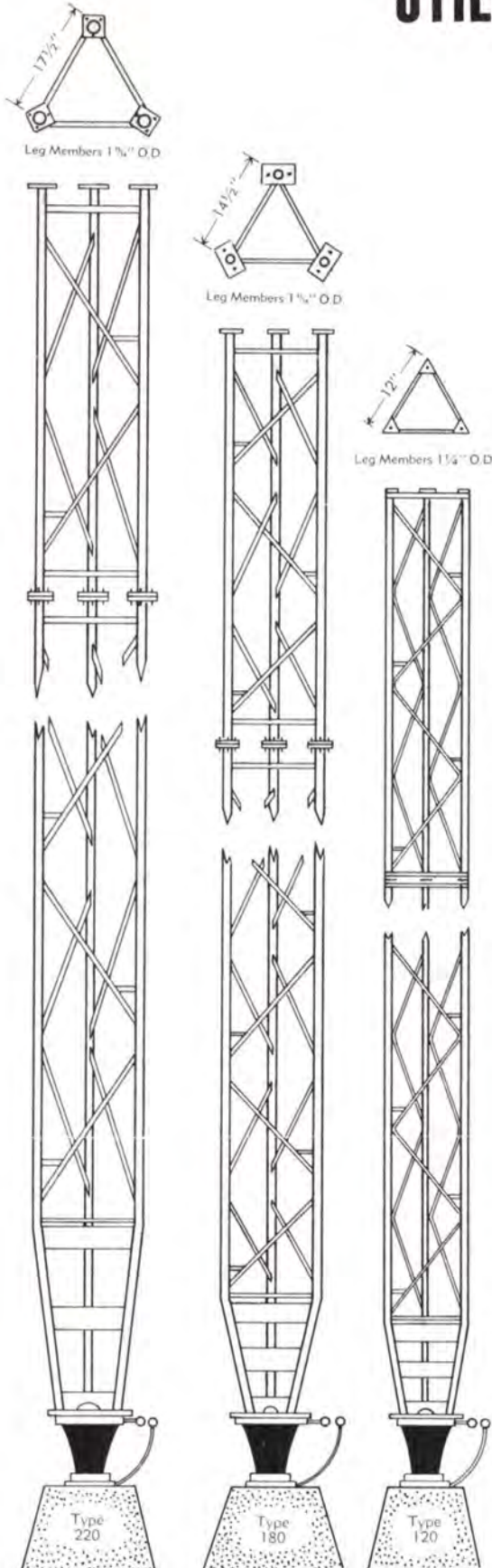

Utility Towers are available in six basic designs, three of which are shown here. All have superior Utility engineering and workmanship and always meet or exceed RETMA specifications. In the five standard models, round members are welded together in 20-foot sections except for top section which is to your measurement. You have choice of hot dip galvanized or rust-inhibitive primer finish.

**RIGID ANCHOR BEAMS:** Anchors are individually designed to meet the requirements of each tower installation. Utility uses the I-beam with its proven structural rigidity. This beam is imbedded in concrete slab re-inforced with steel rods and with earth fill on top.

**SOLID BASE INSULATORS:** Insulated vertical radiators are equipped with the latest Utility 3401 or Utility 2201 pivot base insulators for positive insulation between base and ground. Utility base insulators have much higher compression rating than hollow insulators of similar size. Resilient. Shatter-proof. Each insulator is proof tested for a load approximately eight times greater than ever carried in normal broadcast service.

**EASY TUNING:** You save money on initial engineering costs because Utility Towers are easier to tune. One reason for this is the fact they are built to your exact requirements.

**SMALLER CONCRETE PIER:** Diversified tower support makes massive concrete bases or piers unnecessary — thus doing the job for you at less cost.

**EASY MAINTENANCE:** Round members and welded construction provide smooth surfaces for easy painting and servicing. Steps are built into bracing to eliminate need for scaffolding and to make entire height of tower easy for maintenance men to reach.

## SPECIFICATIONS

TOWER TYPE	MAXIMUM RECOMMENDED HEIGHT	TOWER WIDTH	WEIGHT PER FOOT*	TYPE OF BASE INSULATION
480	480 FT.	33 IN.	28 LBS.	LOCKE OR LAPP
340	350 FT.	19-7/8 IN.	17 LBS.	UTILITY 3401
220	250 FT.	19-7/16 IN.	12.5 LBS.	UTILITY 3401
180	200 FT.	16-3/16 IN.	10 LBS.	UTILITY 2201
120	200 FT.	13-1/4 IN.	8 LBS.	UTILITY 2201
170KD	320 FT.	18 IN.	17 LBS.	UTILITY 3401

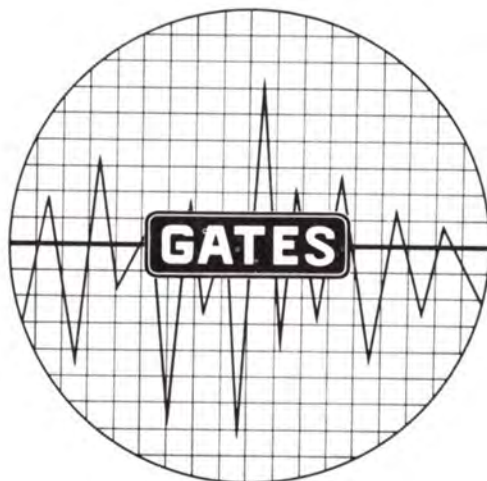

# **AUDIO EQUIPMENT AND ACCESSORIES**

## **PAGES**

<b>110-128</b>	<b>AUDIO CONSOLES</b>
<b>130-139</b>	<b>TURNTABLES AND ACCESSORIES</b>
<b>140-153</b>	<b>AUTOMATIC PROGRAMMING, FULL TIME AND SPOT BROADCASTING</b>
<b>154-188</b>	<b>AUDIO ACCESSORY EQUIPMENT</b>

# DUALUX DUAL SPEECH INPUT EQUIPMENT



Evidence of "Dualux" acceptance is its wide usage in major market stations and by nearly a score of the country's major recording studios. Outstanding features of the Dualux include (1) Selective monitoring of all major circuits. (2) Eight utility keys for expansion. Six are at the left and two to the right. (3) A three-position high-pass filter for quick program correction. (4) Telephone type keys on all mixing channels for increased flexibility. (5) Five preamplifiers wired for 7 microphones. Up to 22 microphones if all utility keys are used. Space for 2 more preamplifiers provided. (6) Complete inbuilt cue-intercom with front panel listen and talkback. (7) Cue-attenuators on 4 mixing channels used for net, turntables, tapes and remotes. (8) Dual program amplifiers. (9) Fully regulated power supply.

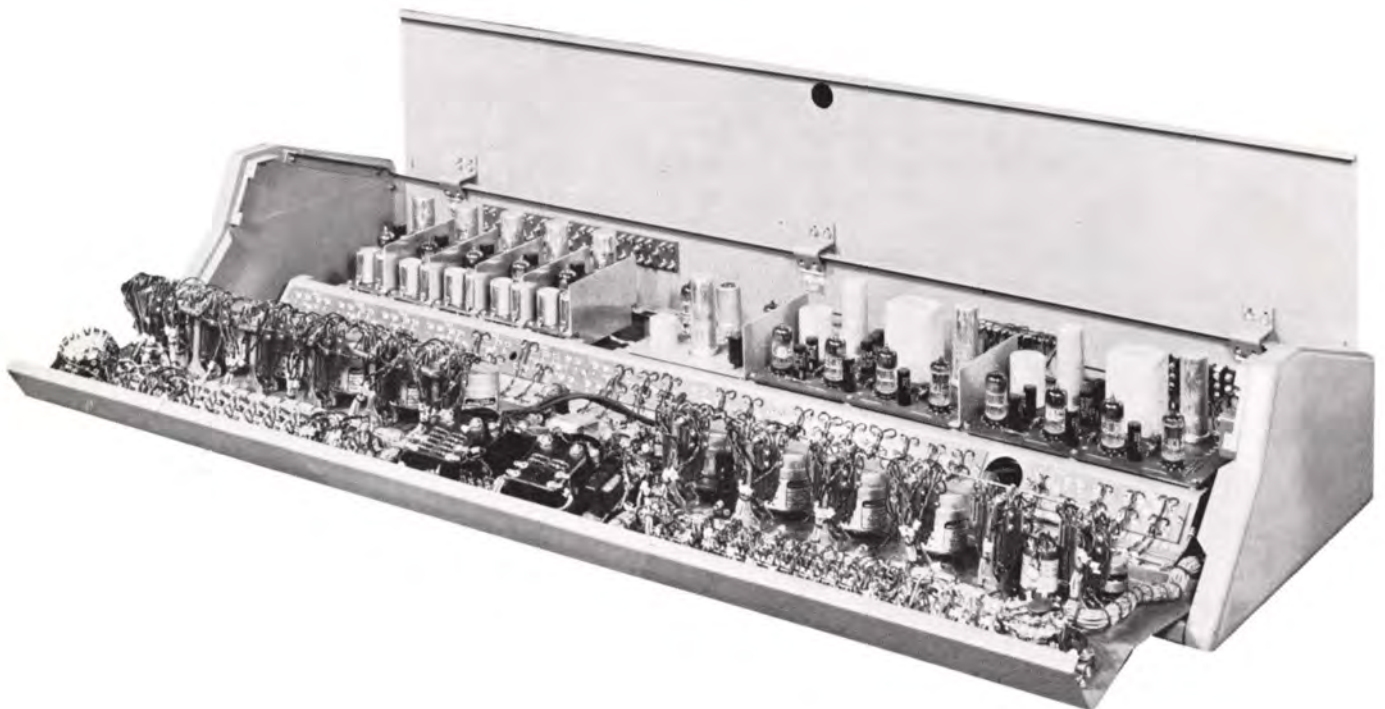

## DUALUX DUAL SPEECH INPUT EQUIPMENT

### SPECIFICATIONS

**MIXING CHANNELS:** 9 keys selected to either program amplifier. Includes 5 microphone attenuators and 4 high-level attenuators with cue position used for turntables, tapes, networks.

**MICROPHONE INPUTS:** As wired, 7 microphones switchable to 5 preamplifiers. However, by use of auxiliary keys, as many as 22 microphones may be accommodated.

**TURNTABLE/TAPE/NETWORK INPUTS:** 4 turntables switchable into mixing channels 6 and 7. Network plus 4 tape or projector inputs selectable into either channels 8 or 9 by ingenious keying system to permit fading instead of dumping.

**AMPLIFIERS:** 2 complete high-gain program amplifiers with individual front panel master gain controls are provided for entire dual operation. 5 preamplifiers with provisions for 2 additional preamplifiers for future expansion. Preamplifier, program amplifier, and monitoring amplifier have printed wiring throughout. Monitoring amplifier and regulated power supply mounted on drop down panel for rack mounting. Monitoring amplifier full 10 watt capacity.

**IMPEDANCES:** Preamplifier input 30/50 and 150/250 ohms balanced or unbalanced. Remote, network, tape and projectors 600/150 ohms balanced or unbalanced. Output impedance 600/150 ohms balanced to both program amplifiers. Monitoring amplifier, 8 and 16 ohms. Intercom amplifier, 600 ohms.

**GAIN:** Gain overall, 104 db. From turntable, network, or remote input, 61 db. All measurements  $\pm 2$  db.

**RESPONSE:** Overall or any segment of program circuit,  $\pm 1.5$  db, 30-15,000 cycles. **MONITORING AMPLIFIER:**  $\pm 2$  db, 30 to 15,000 cycles.

**OUTPUT LEVELS AND DISTORTION:** Program line maximum of +8 dbm at 1% or less. Monitoring amplifier maximum of +40 dbm (equivalent to 10 watts) at 1% or less distortion.

**NOISE:** Microphone input to program output 60 db or better below +8 dbm output, using -60 dbm input. Turntable, network and remote inputs 70 db or better below +8 dbm output. **MONITORING CIRCUIT:** 60 db below +40 dbm output.

**CROSS-TALK:** All circuits or segments thereof below noise level with normal levels and control positions.

**TUBES:** (18) 5879, (4) 12AX7, (2) 12AU7, EL84, (1) OA2, 6AK6, 6080, GZ34.

**TOTAL NUMBER OF TUBES:** 30.

**TOTAL TUBE TYPES:** 8.

**RELAYS:** 3 provided with contacts for muting loudspeakers and turning on warning lights.

**SIZE (Dualux):** 46 $\frac{1}{2}$ " wide, 7 $\frac{1}{2}$ " high, 15" deep.

**TOTAL NET WEIGHT:** 101 lbs. Packed weight: 205 lbs.

**CUBAGE:** 9.7 cubic feet.

**SERVICING:** Front panel hinges down to service. Audio amplifier strip hinges up.

**POWER CONSUMPTION:** 155 watts.

**FINISH:** Cabinet in medium gloss gray. Front panel metallic with escutcheons in etched black aluminum. Control knobs supplied with kit of color disc inserts for coding.

**METERING:** Two standard 4" illuminated VU meters recessed behind front panel for easy vision at correct eye level. One meter across program line at all times, the second may be switched across either program line; both meters calibrated +8 dbm output (may be altered for higher or lower levels on request).

**PATCH PANEL:** All main circuits brought to terminal board and strapped together so that normalizing jacks, standard, and patch panels may be used where desired.

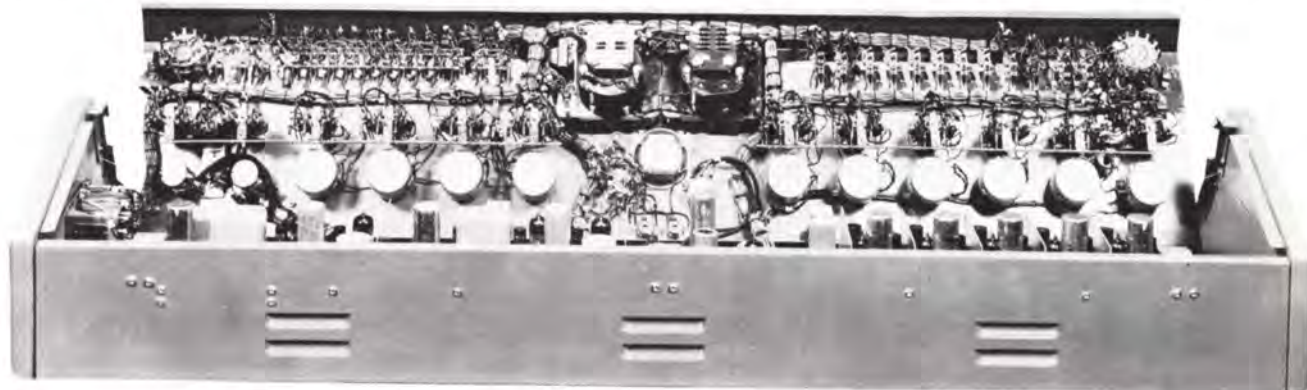

Rear view of Dualux. Note no rear terminations, allowing Dualux to fit against wall where desired.



## DUALUX DUAL SPEECH INPUT EQUIPMENT

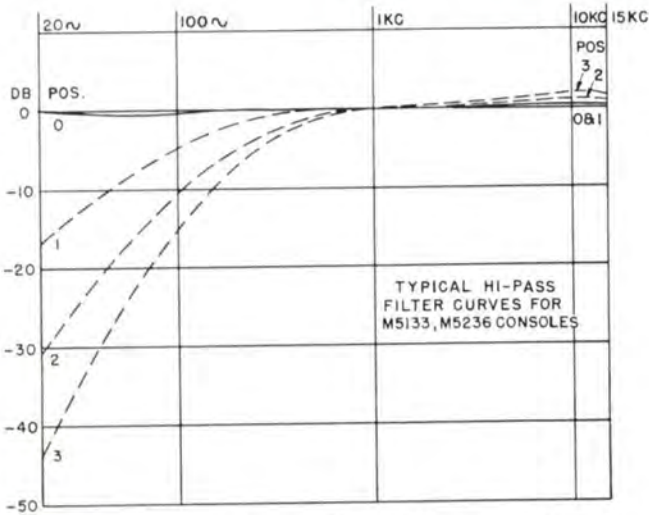

Graph showing four curves Dualux front panel control equalizer.

- 8 external intercom circuits selected with front panel switch.
- 8 cueing circuits selected with front panel switch.
- High gain amplifier provides adequate level for monitoring all intercom circuits.
- All inputs and outputs padded, plus isolation networks where necessary, to allow selection of any circuit without adjusting gain control where levels within 20 db of normal.
- Front panel phone jack will cut cue speaker when phone plug inserted.
- Intercom speaker mutes when announcing from control room.
- Intercom system will listen and talk back on following circuits:

RMT. 1	Turntable Cue*
RMT. 2	Studio A
RMT. 3	Studio B
RMT. 4	Studio C
RMT. 5	Mixer Bus A*
	Mixer Bus B*

\* Listen only.

**REMOTE LINES:** 5 switched into channel 9, also into cueing system. Each remote key has cue/talk-back/mix positions. Duplicate line isolation transformers in channels 8 and 9 to handle any unbalanced condition.

**EQUALIZER (High-Pass Filter):** Direct front panel control for Program Channel A. A flat position and 3 selected response curves allow immediate elimination of hum, rumble or extraneous circuit noise at low frequencies. (See response curves).

**CUE-INTERCOM SYSTEM:** Loudspeaker and switching facilities directly in front center of Dualux console. May be used with M-5303 sub-station or any similar equipment for studio talk-back, providing following exclusive features:

- Interlocked and cannot interfere with programming.



Fully regulated power supply. Relays are powered from main power supply and located inside of drop-panel housing.



Dualux and desk. Desk designed specifically for the Dualux, with sides and back of 16 gg. stretcher level furniture steel finished in medium gray. Top is of formed linen formica in charcoal gray attached to seasoned 5-ply birch. Three wiring troughs extend down the inside rear to conceal wiring from console to floor. Leveling screws are on all four corners. Size: 47" wide, 30" front to back, height 29" adjustable to 30 1/4". Shipped knocked down.

# DUALUX DUAL SPEECH INPUT EQUIPMENT

## ORDERING INFORMATION

- Dualux speech input console with tubes and ready to install .....M-5236A
- Extra preamplifiers for above .....M-5304
- Extra muting relays for above .....AK-11939
- Intercom sub-station for above .....M-5303
- 100% spare tube complement for above .....TK-294



M-5303 sub-station for studio intercom to talk back to control board. Includes matching transformer.

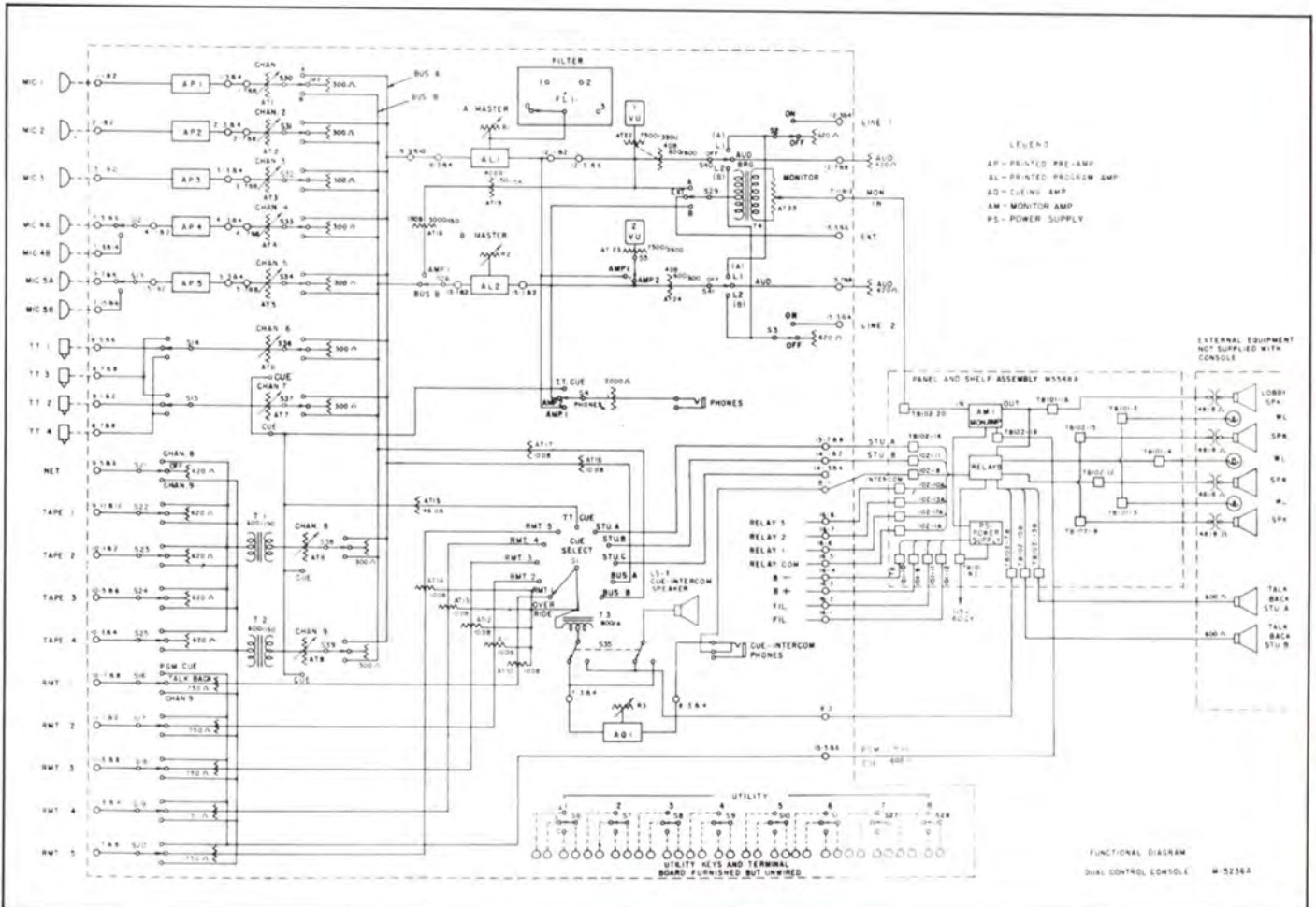

## GATESWAY 8-CHANNEL SPEECH INPUT SYSTEM



The Gatesway is one of the most comprehensive audio systems manufactured today. Eight step type mixing channels accommodate five microphones into four preamplifiers (15 microphones by use of utility keys), four turntables, four tapes, network, and multiple remote lines. The Gatesway includes the exclusive 10 watt ultra linear amplifier, variable high-pass filter, inbuilt cue-intercom, and five unwired utility keys for individual needs. Twenty-seven keys accommodate 52 switching functions for almost any conceivable broadcast use. Relays are powered from the fully regulated power supply and located inside of drop-panel housing. The monitoring amplifier is also on this panel.

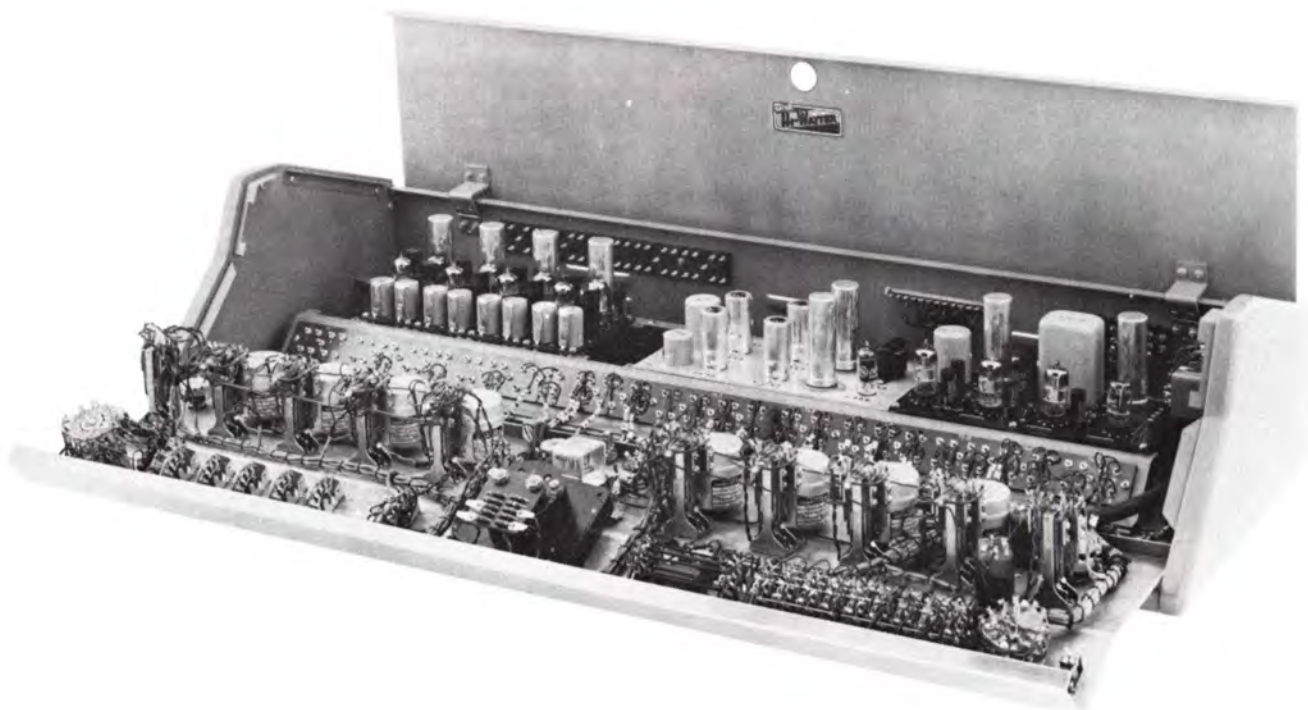

## GATESWAY 8-CHANNEL SPEECH INPUT SYSTEM



Rear view illustrates how console may be set against wall, as all terminations are made on inside for both electrical and mechanical protection.

### SPECIFICATIONS

**MIXING CHANNELS:** 8 ladder type. Ninth mixing channel may be added in place of monitor gain control which is moved to chassis of monitor amplifier.

**MIXER KEYS:** Selects each mixing control into: (a) program amplifier, (b) monitor/emergency amplifier, (c) cue amplifier/speaker. Also provides speaker/warning light control through relays included.

**TURNTABLE INPUTS:** 4, key selected into mixing channels 5 and 6. Connects turntables, through mixer, to: (a) program amplifier, (b) monitor amplifier, (c) cue/speaker amplifier.

**TAPE INPUTS:** 4, key selected into mixing channels 7 and 8. Connects tapes, through mixer, to: (a) program amplifier, (b) monitor amplifier, (c) cue/speaker amplifier.

**NET INPUT:** 1 key for network of any 600 ohm line into mixing channels 5 or 6, to: (a) program amplifier, (b) monitor amplifier, (c) cue/speaker amplifier.

**MICROPHONE INPUTS:** As wired, accommodates 5 into 4 preamplifiers. Additional mike input may be had by using utility key 5 into mixing channel 3.

**NUMBER OF PREAMPLIFIERS:** 4, with provision for 2 additional preamplifiers for future expansion.

#### IMPEDANCES:

Mic inputs .....	30/50 and 150/250 ohms.
TT inputs .....	150-250 ohms.
Tape inputs .....	500/600 ohms.
Net input .....	600 ohms.*
Rmt inputs .....	600 ohms.*
Ext. input (monitor) .....	600 ohms.
Pro. amp. output .....	600 ohms.
Mon. amp. output .....	8 and 16 ohms.
Loudspeakers .....	matching to 8/16 ohms.**
Headphones .....	5000 ohms or higher.
Ext. cue speaker .....	600 ohms.

\*May be adjusted to other NAB standards such as 50/150/250 by tapped primary on isolation transformer.

\*\*Speakers in parallel circuit. Example: 2 speakers 32 ohms, 3 speakers 48 ohms, etc., by use of speaker matching transformer on speaker.

**GAIN:** From mic input to program line output, 104 db. From remote line, net, tape and turntables to program line output, 61 db.

**NOTE:** All gains stated  $\pm 2$  db.

**RESPONSE:**  $\pm 1.5$  db 30-15,000 cycles (standard mode of operation).  $\pm 2.0$  db 30-15,000 cycles (emergency circuits).

**DISTORTION:** 1% or less 30-15,000 cycles all program circuits measured at +8 dbm output. 1% or less 50-15,000 cycles all monitoring circuits measured at +40 dbm (10 watts).

**NOISE:** Program circuit . . . 60 db or better below +8 dbm measured at -60 dbm input. Monitoring amplifier . . . 60 db below +40 dbm output.

**CROSS-TALK:** Below microphone channel noise level within normal inputs and control position.

**TUBES:** Preamplifiers . . . two 5879, total 8, Program Amplifier . . . three 5879, one 12AU7. Booster Amplifier . . . one 12AX7. Cue Amplifier . . . one 5879, one 12AX7, one 6AK6. Monitor Amplifier . . . two 12AX7, two EL84. Power Supply . . . one GZ34, one 6080, one 5879, one OA2. Total Tubes: (13) 5879, (4) 12AX7, (2) EL84, (1) 12AU7, 6AK6, 6080, GZ34, OA2.

**TOTAL NUMBER OF TUBES:** 24.

**TOTAL TUBE TYPES:** 8.

**RELAYS:** 3 provided telephone type with contacts for muting loudspeakers and breaks 115 volt circuit for warn-



Adding to serviceability, the entire amplifier framework hinges up. In this way, every under chassis connection may be instantly reached. Easily kept clean, too.

## GATESWAY 8-CHANNEL SPEECH INPUT SYSTEM

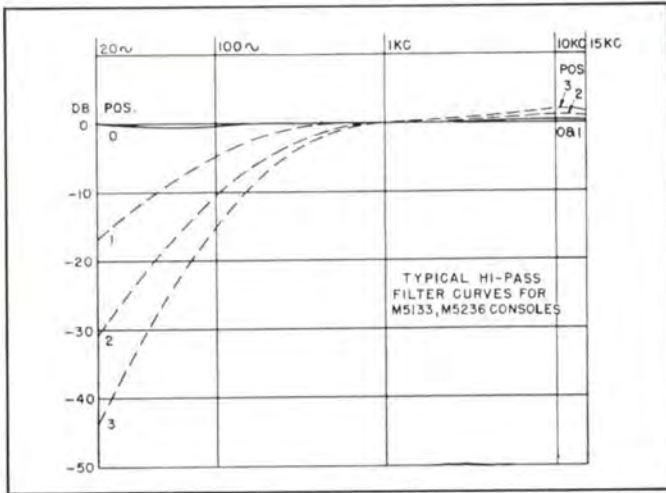

Curve of hi-pass filter. Three degrees of low frequency cutoff may be inserted without clicks or loss of gain. This feature is indispensable for booming microphones, moving sets or hum from remote lines.

ing lights up to 60 watts per light. Room for 2 added relays on chassis where unusual muting or control requirements exist. Relays operate from console power supply.

**SIZE:** 39" wide, 15" front to back, 7 $\frac{1}{2}$ " high. Height (lid up), 12 $\frac{1}{2}$ ".

**WEIGHT:** Net, Console, 52 lbs. Power Supply and monitoring unit, 39 lbs. Total packed weight, 175 lbs.

**CUBAGE:** 8.5 cubic feet.

**PRIMARY POWER:** 115 volts, 50/60 cycles, approximately 105 watts.

**POWER CONSUMPTION:** 115 watts.

**FINISH:** Cabinet in medium gloss gray. Front panel metallic with escutcheons in etched black and aluminum

lettering. Control knobs supplied with kit of color disc inserts for coding.

**VU METER:** Standard 4" scale B illuminated. Reads output of program line, peaking to 0 VU when output level is +8 VU.

**CUE AMPLIFIER:** Fixed pads at all circuits provide adjusted uniform input level to proper cue speaker level. Also provides proper level to operate directly remote cue intercom speaker at room level.

**REMOTE LINES:** 4, key selected into mixing channels 7 and 8. Key up — feeds program cue to remote line. Key center — feeds cue/speaker amplifier to remote line for both talking and listening. Key down — remote line on air.

**CUE SPEAKER/AMPLIFIER SELECTOR:** Selects cue speaker/amplifier for both talk and listen into: all remote lines, 3 studios and utility line. Selects to listen only on turntables, tape recorders, audition buss and program line.

**UTILITY KEYS:** 5 provided, unwired, located to left upper center of VU meter. Provided for specific requirements of individual installation such as additional remote lines, tape inputs, etc.

**OUTPUT EMERGENCY KEY:** Located above master gain. In case of failure of program amplifier, the output



Desk designed for Gatesway console. Sides and back of 16 gg. stretcher level furniture steel finished in medium gray. Top is of formed linen formica in charcoal gray attached to seasoned 5-ply birch. Three wiring troughs extend down the inside rear to conceal wiring from console to floor. Leveling screws are on all four corners. Size: 39 $\frac{1}{2}$ " wide, 30" front to back, height 29" adjustable to 30 $\frac{1}{4}$ ". Shipped knocked down.



Power supply and monitoring unit; drop-panel housing.

## GATESWAY 8-CHANNEL SPEECH INPUT SYSTEM

of the monitoring amplifier may be instantly connected to the program line. Does not disconnect loudspeakers.

**MONITOR INPUT KEY:** Located above monitor gain control. Allows switching of monitoring amplifier to: (a) padded output of program amplifier, (b) audition buss, and (c) external pair for any other input.

**PATCH PANEL TAKE-OFF:** Jumpers provided for patch panel interlock at output of all preamplifiers and input and output of both program and monitoring amplifiers.



### ORDERING INFORMATION

- Gatesway speech input console with tubes and ready to install ..... **M-5133A**
- Extra preamplifiers for above ..... **M-5304**
- Extra muting relays for above ..... **AK-11939**
- Intercom sub-station for above ..... **M-5303**
- 100% spare tube complement for above ..... **TK-290**

M-5303 sub-station for use with self-contained Gatesway cue-intercom amplifier. Includes matching transformer. Intercom is automatically muted when live microphones adjoin.

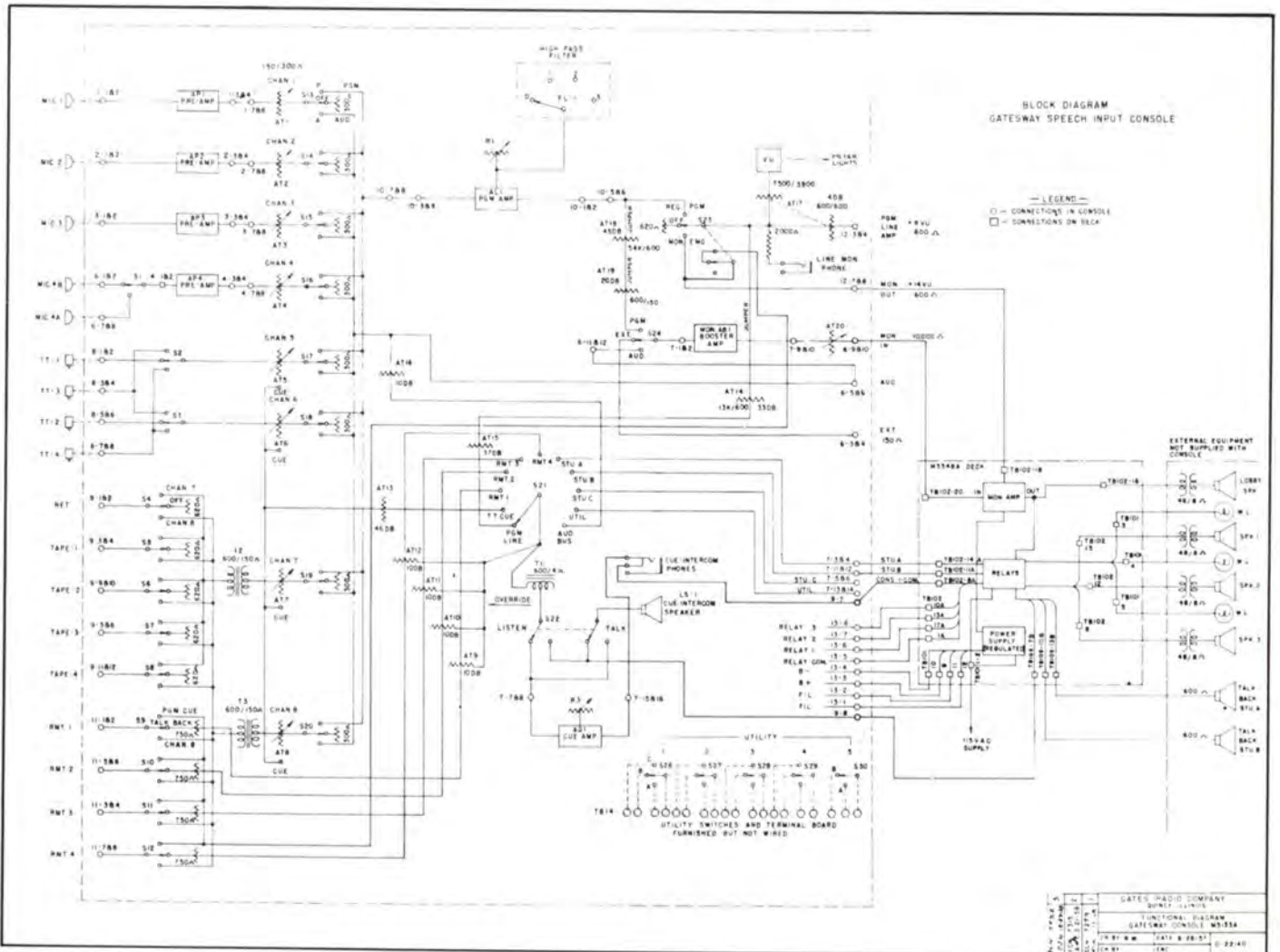

## YARD 8-CHANNEL SPEECH INPUT SYSTEM



Adaptable to either radio or television studio control, the Gates Yard is compact, designed with extra facilities to meet all station requirements, and styled for the modern broadcaster.

On all standard Yard consoles, there are 3 preamplifiers with input switching for 6 microphones, and with space provided for 5 additional preamplifiers. This means it is possible to have a maximum of 11 microphone inputs, offering flexibility for every type of station.

Other outstanding features include: 8 mixing channels key

selected into the program or monitoring bus accommodating many combinations of microphones, turntables, tape playbacks and projectors with provision for network and remote lines; a self-contained cue amplifier and speaker for turntable and projector channels; an ultra-linear 10 watt monitoring amplifier; and a regulated power supply for uniformity of performance. The broadcaster will also appreciate the low, compact silhouette for good over-the-top vision; dual muting relays with space for 3 more where needed; step-type attenuators for all mixing channels; and low impedance mixing throughout. Servicing of the Yard is extremely simple.

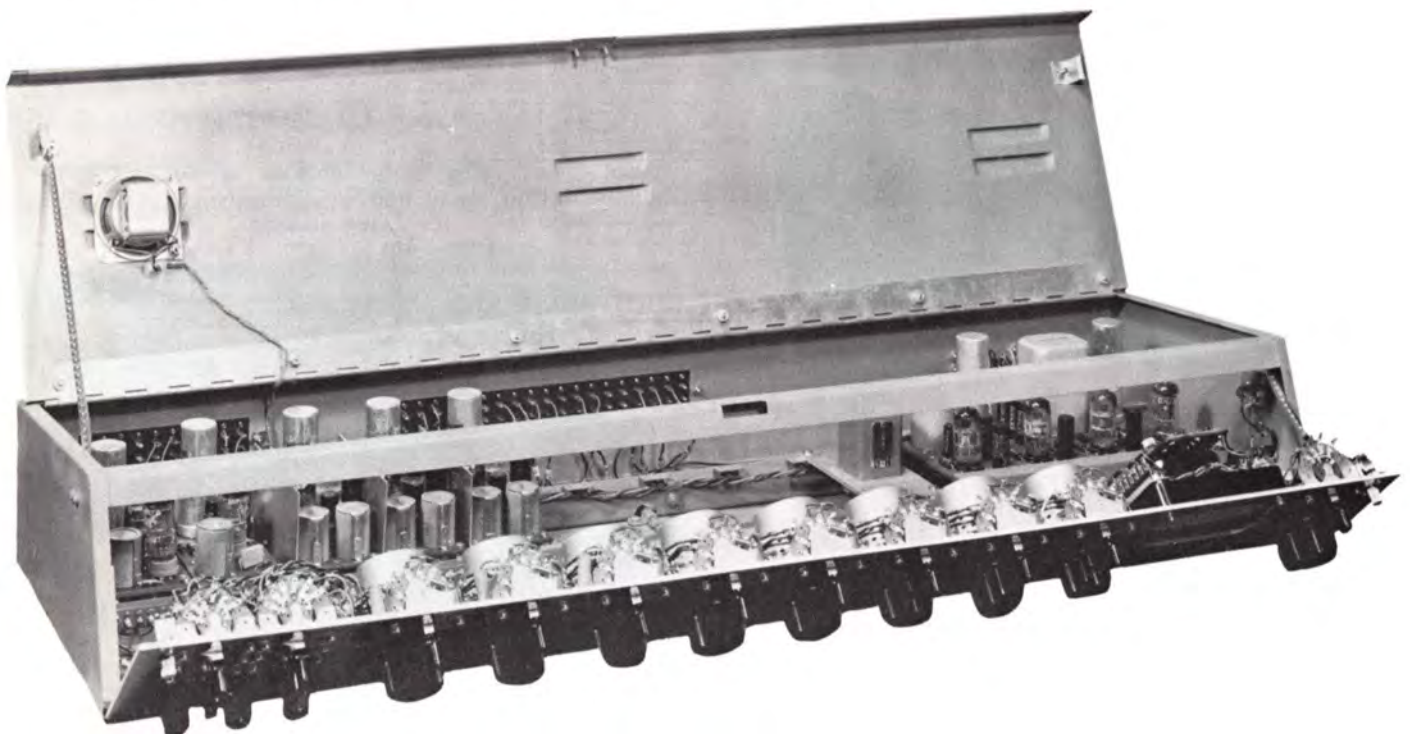

## YARD 8-CHANNEL SPEECH INPUT SYSTEM



Rear view of Yard shows simplicity of detail. Wiring is to numbered screw terminals.

### SPECIFICATIONS

**MIXING CHANNELS:** Eight channels are each key selected into the program or monitoring amplifier bus. Controls are the step type low impedance having 20 steps of 2 db. Channels 6 and 7 have cue connection at infinity (off). This cue feeds the output from Channel 6 or 7 to cueing amplifier/speaker as employed for turntable cue up. Muting relays operate in conjunction with these keys and are wired to the first three channels. Sufficient contacts are on all channel keys for additional relay muting. Audition bus is connected to terminals for recording as well as switch selectable to the monitoring amplifier.

**PREAMPLIFIERS:** Three are provided as standard. Room is available for five more. Each of the three preamplifiers has an input key to select between two microphones for each preamplifier, giving a six microphone capacity. Muting relays may be connected in any usable combination with both input and mixing channel keys. Additional M-5304 preamplifiers require only installation and connection to the available filament and plate supply in the console. When using the maximum of eight preamplifiers, the total microphone capacity is eleven.

**IMPEDANCES:** Microphone input to preamplifiers, 30/50—150/250 ohms.  
Turntable, projector, tape input to mixer, 150/250 ohms.  
Remote line, network input to mixer, 150/250—500/600 ohms.  
Program line output, 500/600 ohms.  
Monitoring amplifier output, 8 or 16 ohms.

- GAIN:**
- (a) Any preamplifier input to program line output: 103 db.
  - (b) Any preamplifier input to monitoring amplifier output: 130 db.
  - (c) Any turntable, tape, projector or network input to program line output: 60 db.
  - (d) Any turntable, tape, projector or network input to monitoring amplifier output: 87 db.

**NOTE:** Gain of monitoring amplifier is reduced by fixed pad when operating from output of program amplifier. All gain measurements stated are  $\pm 2$  db.

**RESPONSE:** Program circuits  $\pm 1\frac{1}{2}$  db, 30-15,000 cycles.  
Monitor circuits  $\pm 2$  db, 30-15,000 cycles.

**OUTPUT LEVELS AND DISTORTION:** Program line of 8 dbm at 1% or less distortion. Monitoring amplifier maximum of +40 dbm (equivalent to 10 watts) at 1% or less distortion.

**NOISE:** Program circuit including preamplifier 60 db or better below +8 dbm output with -60 dbm input.

Equivalent noise input is -120 dbm.

Monitor circuit 62 db below +40 dbm output.

**TUBES:** Preamplifiers each (2) 5879.

Program amplifiers (3) 5879 and (1) 12AU7.

Cueing amplifier (1) 12AX7 and (1) 6AK6.

Monitor booster amplifier (1) 12AX7.

Monitoring amplifier (2) 12AX7 and (2) EL84.

Power supply, one each OA2, 5879, 6080, 5V4 (GZ34).

**TOTAL TUBES:** (standard model with 3 preamplifiers) 21.

**TOTAL TUBE TYPES:** 8.

**RELAYS:** Provision is made for five relays. Two relays are supplied as standard. These mount behind the drop-down panel of the power supply/monitor unit. Contacts are provided for both speaker muting and warning lights. Muting relays are high quality telephone type and operate from control keys on console in a wide variety of circuit combinations to suit the purchaser's desires.



Want to add another microphone channel? There is room for five more M-5304 printed wiring 2-stage preamplifiers. Add as you wish, or a TV station might wish all eight at once.



## YARD 8-CHANNEL SPEECH INPUT SYSTEM

- SIZE:** — Console, 36" wide, 5 $\frac{3}{4}$ " high, 12 $\frac{1}{2}$ " deep.  
 — Power/monitoring/muting unit, 19" wide, 7" high, 8" deep. Front panel drops down to service.  
 — Optional desk, 30" high, 36" wide, 25 $\frac{1}{2}$ " deep with desk (front to console) depth 12".

**WEIGHT:** Net weight 77 lbs. Packed weight 90 lbs.

**CUBAGE:** 7.1 cubic feet.

**SERVICING:** All printed circuit amplifiers are the same depth and mount on a channel strip extending the full width of the console. The front panel hinges out to reach all controls and switches instantly. Cabinet lid hinges up for reaching every part, tube and termination.

**POWER:** 115 volts, 50/60 cycles.

**POWER CONSUMPTION:** 130 watts.

**TERMINATIONS** are to numbered terminal boards and installation is simplified by easy accessibility to all terminals.

**FINISH:** Cabinet medium gloss gray. Panel anodized aluminum in natural and black. Knobs furnished with color decal kit. Desk, medium gloss gray to match cabinet of Yard.

**VU METER** is a standard 4" illuminated, flush mounted meter and operates at all times in the program line circuit.

**CUE-AMPLIFIER/SPEAKER** is inbuilt and has its own control at the extreme panel left. Speaker is mounted in the console lid. Output from remote lines and mixing channels 6 and 7 are switchable to the cueing amplifier. The "Yard" is the only console in its price range with an inbuilt 100% cueing system.

**MONITORING AMPLIFIER:** In today's modern broadcasting, loudspeaker distribution is increasingly important. Standard "Yard" equipment includes an ultra linear 10 watt, 1% distortion amplifier. The popular EL84 tubes are utilized in the push-pull output circuit.

**MONITOR BOOSTER:** This added "Yard" exclusive provides a separate voltage amplifier to bring the monitor-audition bus level to equal the program bus level. This makes it possible to switch from program to monitor with no change in level. The output of this amplifier is connected to a pair of terminals for recording direct from any mixing channel. The monitoring amplifier, power supply and muting relay unit are in a separate unit as illustrated.

**PROGRAM AMPLIFIER** has four stages and an abundance of gain for wide control. Both input and output are low impedance. No high impedance circuits are used at any place in the "Yard."

**REMOTE/NET KEYS:** Three incoming lines are selected



Monitoring amplifier, regulated power supply and muting relays are a separate husky rack or desk mount unit.



Desk designed specifically for the Yard. 30" high, 36" wide, 25 $\frac{1}{2}$ " deep.

by three keys to the extreme left. These lines feed through a line isolation transformer. The two remote lines are selectable to "Program Cue," "Cueing Amplifier" and "Broadcast." The "Network" key may be used for a remote line where the station is independent.

**SPEAKER MATCHING TRANSFORMER:** Available as an accessory where several speakers are multiplied to the 16 ohm output. Primary 48 ohms, secondary 8 ohms. Not required where 2 or 3 speakers are the maximum.

# YARD 8-CHANNEL SPEECH INPUT SYSTEM

## ORDERING INFORMATION

- YARD SPEECH INPUT CONSOLE with tubes and ready to install ..... M-5526
- Extra preamplifiers for above ..... M-5304
- Extra muting relays for above ..... AK-12626
- 100% spare tube complement for above ..... TK-282

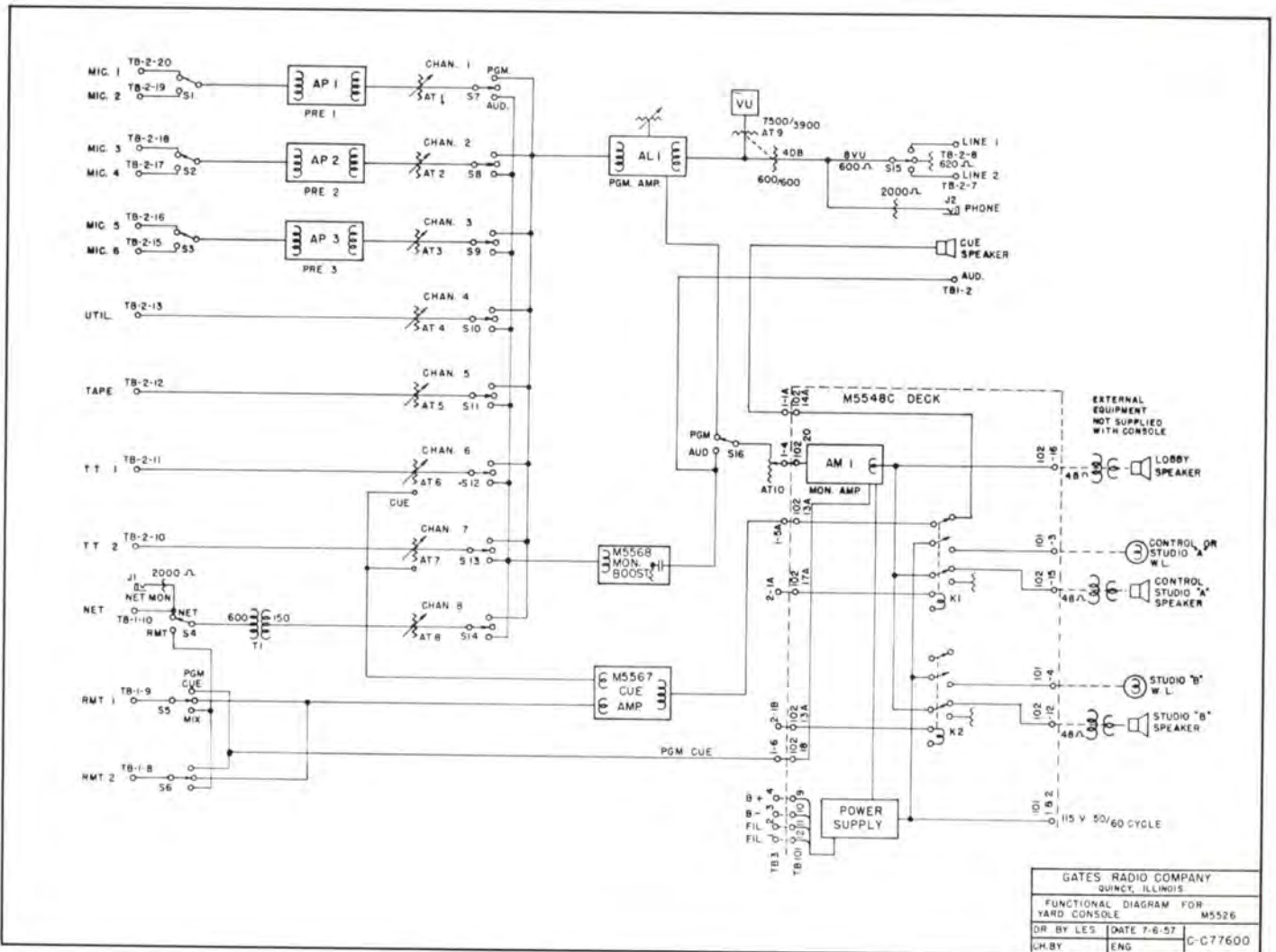

# STUDIOETTE 4-CHANNEL SPEECH INPUT CONSOLE



The Gates Studioette is a perfect blending of workhorse versatility and functional design for modern styling. Here, an unusual generosity of controls, new performance standards, service ease and smart commercial appearance are combined with quality engineering and materials to satisfy the most demanding broadcaster.

The Studioette condenses big console facilities into the ease of four mixing channels. Four channel, step type

mixer with generous key switching facilities accommodates four microphones into two preamplifiers, three turntables, two tapes or projectors, network and three remote lines. Three utility keys are provided for your individual needs. The Studioette also includes a high gain program amplifier, 10 watt ultra linear monitoring amplifier, dual muting and warning light relays, 4" illuminated VU meter, complete cueing facilities for turntables, net, tapes and remotes, and output emergency key.

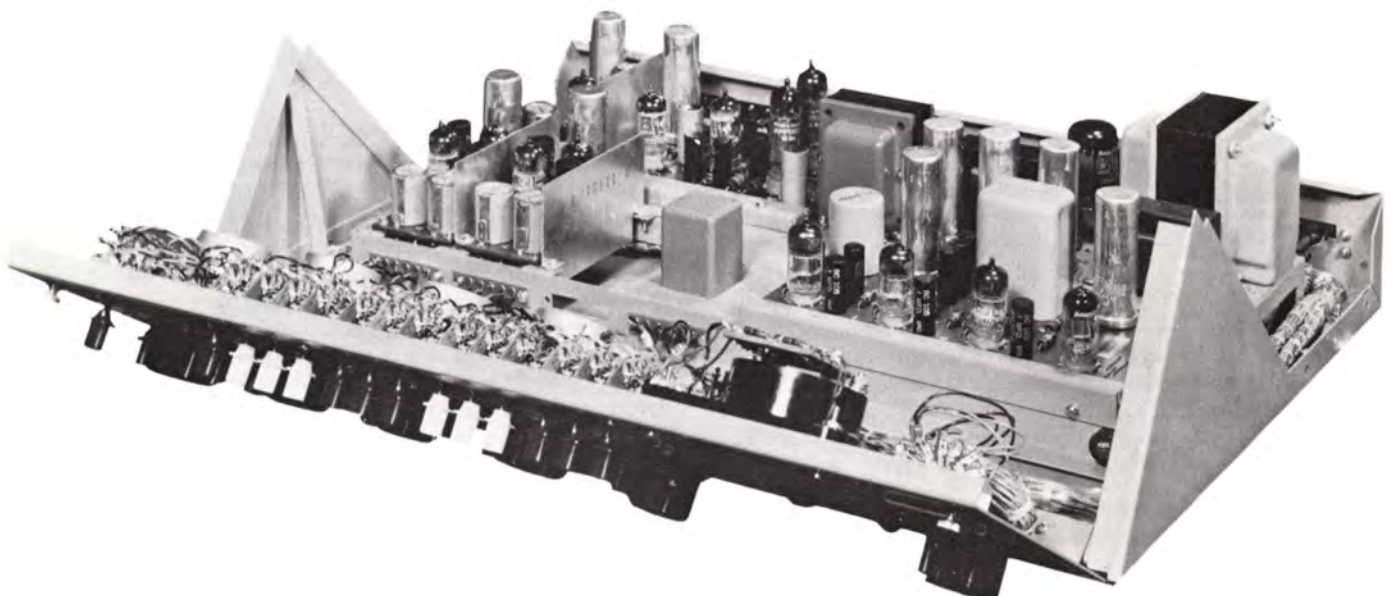

## STUDIOETTE 4-CHANNEL SPEECH INPUT SYSTEM

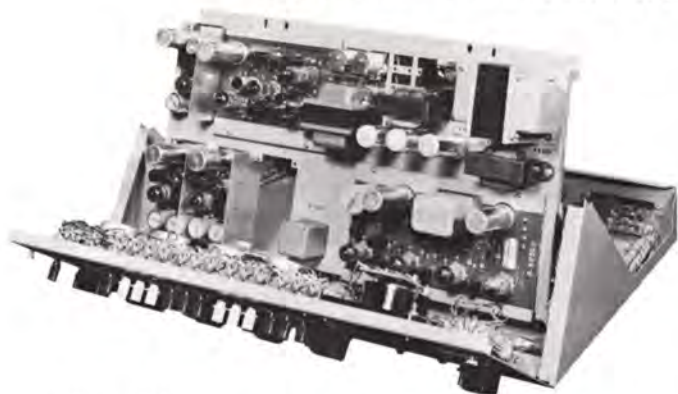

Above, lid is completely removed. Front panel hinges out to reach every "behind the panel" component. Cleaning the step type controls or replacing the meter lamp can even be enjoyable. The amplifier deck hinges up so that muting relay contacts are at finger tip when touch-up burnishing is required. Tubes may be slipped out for checking in half the time and half the element of breakage.

### SPECIFICATIONS

**MIXING CHANNELS:** There are four mixing channels. Each is key selected to either the program or monitor bus. The monitor bus also feeds an external pair of terminals for recording, etc. Each mixing channel is low impedance and has a step type control having 20 steps of 2 db. Channels 3 and 4 have cue position at infinity or off position of the mixer. The block diagram excellently illustrates the function of the mixer as related to circuit control.

**PREAMPLIFIERS:** Two are supplied as standard equipment. Space is allowed for a third M5215 preamplifier which may be added, when needed, in a few minutes. As three unwired spare (utility) keys are part of the Studioette front panel complement, the third preamplifier may accommodate two more microphones and connected as one leg of the 3-input turntable channel. As space is also provided for two more muting relays, the extra preamplifier is compatible with the speaker muting requirement.

### IMPEDANCES:

Input to preamplifiers, 30/50 and 150/250 ohms.  
Turntable inputs, 150/250 ohms.  
Tape, network, remote line inputs, 500/600 ohms.  
Program line output, 500/600 ohms.  
Monitoring amplifier output, 8 and 16 ohms.\*

\*When monitoring amplifier is used as emergency program amplifier, a bridging pad converts to 500 ohms impedance. Also may be used with ZY2003 speaker matching transformer where 500 ohms to speakers is desired (see Index "Speaker Matching Transformers").

- GAIN:** (a) Any preamplifier input to program line output 103 db.  $\pm 2$  db.  
(b) Any preamplifier input to monitoring amplifier output 140 db.  $\pm 3$  db.  
(c) Any turntable, net, tape or remote line input to program line output 63 db. +2 db.  
(d) Any turntable, net, tape or remote line input to monitoring amplifier output 100 db.  $\pm 3$  db.

**NOTE:** Gain of monitoring amplifier is reduced by a fixed pad when operating from output of the program line.

**RESPONSE:** Program circuits  $\pm 1\frac{1}{2}$  db, 30-15,000 cycles.  
Monitor (audition) circuits  $\pm 2$  db, 30-15,000 cycles.

**OUTPUT LEVELS AND DISTORTION:** Program line maximum of +8 dbm at 1% or less distortion. Monitoring amplifier maximum of +40 dbm (equivalent to 10 watts) at 1% or less distortion.

**NOISE:** Program circuits including preamplifier, 60 db below +8 dbm output with -60 dbm input. Equivalent noise input is -120 dbm. Monitor (audition) circuits, 55 db below +40 dbm output.

**TUBES:** Preamplifiers, each (2) 5879.  
Program amplifier, (3) 5879, (1) 12AU7.  
Monitor booster amplifier, (1) 12AX7.  
Monitor amplifier, (2) 12AX7, (2) EL84.  
Power supply, (2) OA2, (1) GZ-34.

**TOTAL TUBES:** 16.

**TOTAL TUBE TYPES:** 6.

**RELAYS:** Two are supplied as standard with space for two additional relays where needed. These relays operate in conjunction with microphone keys S1 and S2 and mixing keys S12 and S13 (see functional diagram). Any muting arrangement is possible. Relay contacts are supplied for operation of warning lights as well as loudspeaker muting.

**SIZE:** 24" wide, 8 $\frac{1}{4}$ " highest point, 17" deep.

**WEIGHT:** Net weight, 55 lbs. Packed weight, 70 lbs.

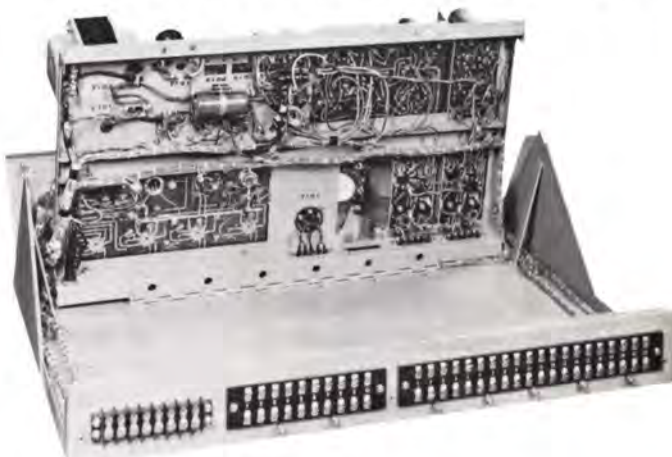

Above is the reverse view of the top illustration. Here the wonderful uniformity and reliability of printed wiring tells the obvious story of excellence. Each amplifier is always the same as each wire is always in the same errorless place with no possibility of insulation chafing or deterioration. In servicing, there is no maze of wires winding under and above components. The chance of rosin joints is essentially eliminated with the machine soldering technique in printed wiring.

## STUDIOETTE 4-CHANNEL SPEECH INPUT SYSTEM

CUBAGE: 4.6 cubic feet.

POWER: 115 volts, 50/60 cycles.

POWER CONSUMPTION: 120 watts.

TERMINATIONS: Numbered screw terminals.

FINISH: Cabinet in medium, hand rubbed, gloss gray. Panel in second tone of gray with escutcheons in anodized black and natural aluminum.

ADDITIONAL FACILITIES include an output emergency key where the program line may be switched to the monitoring amplifier output in case of a noisy tube, etc., developing in the program amplifier during a broadcast. A monitor selector key switches the monitoring amplifier input to: (1) program line for monitoring, (2) external terminals for external input, and (3) audition buss of the mixing system. A headphone jack is across the program line at all times. — The 4" illuminated VU meter is flush mounted with the case back panel mounted. The meter is connected to the program line and indicates +8 VU at 0 scale reading.

POWER SUPPLY is self-contained in the Studioette and supplies all voltages for filament and plate requirements. Extra capacity is available for the optional third preamplifier and optional muting relays.

MONITORING AMPLIFIER is ultra linear type and delivers a full 10 watts at 1% or less distortion. Also 100% printed wiring.

MONITOR BOOSTER: A two-stage printed wiring amplifier between the audition bus of the mixer and input to the monitoring amplifier. This feature provides balanced level between the program and audition bus so when switching the operator needs not readjust gain settings.

CUEING: When mixing channels 3 and 4 are at OFF position, they automatically connect to a pair of terminals to which a cueing amplifier may be attached. The new Gates M5377 desk mount cueing amplifier is ideal for this service and is described elsewhere in this catalog (see Index, Cueing Amplifier). — With this feature, all circuits feeding mixing channels 3 and 4 may be prechecked including turntables, network, tape inputs and remote lines.

TAPE INPUTS: Two keys select two tape recorder inputs to mixing channel 4 or cue override. Tape inputs may be

utilized for projector inputs where the Studioette is employed in TV.

TURNTABLE INPUTS: Three keys accommodate three turntable inputs. These keys permit switching each of three turntables to either mixing channels 3 or 4.

REMOTE LINES: Three keys select three remote lines in three positions: (1) mixing channel 4 for broadcasting, (2) override, and (3) program cue to the remote line.

SPEAKER MATCHING TRANSFORMER: Where two or three speakers are used, a speaker matching transformer is normally not required. Where more speakers are used, the A30601 matching transformer, 48 ohms to 8 ohms, is available as an optional accessory.

NOTE: All gain measurements are  $\pm 2$  db.

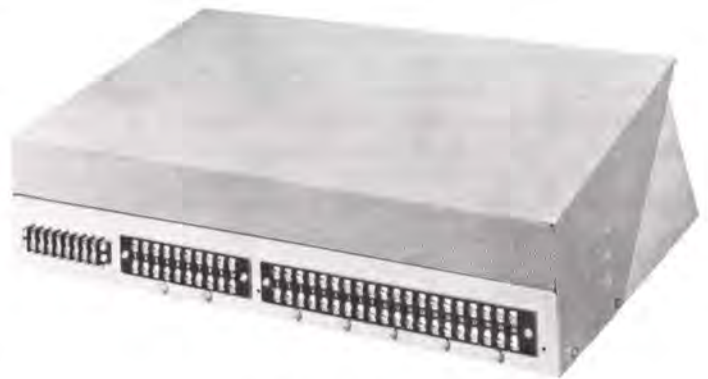

Studioette — Rear view.



The front panel hinges to the cabinet base.

# STUDIOETTE 4-CHANNEL SPEECH INPUT SYSTEM

## ORDERING INFORMATION

- Studioette console complete with tubes, two preamplifiers and two muting relays, ready to use ..... **M-5381**
- Extra preamplifier for above ..... **M-5304**
- Extra muting relay for above ..... **AK-12626**
- Speaker matching transformer ..... **A-30601**
- Spare 100% tube kit for Studioette ..... **TK-270**

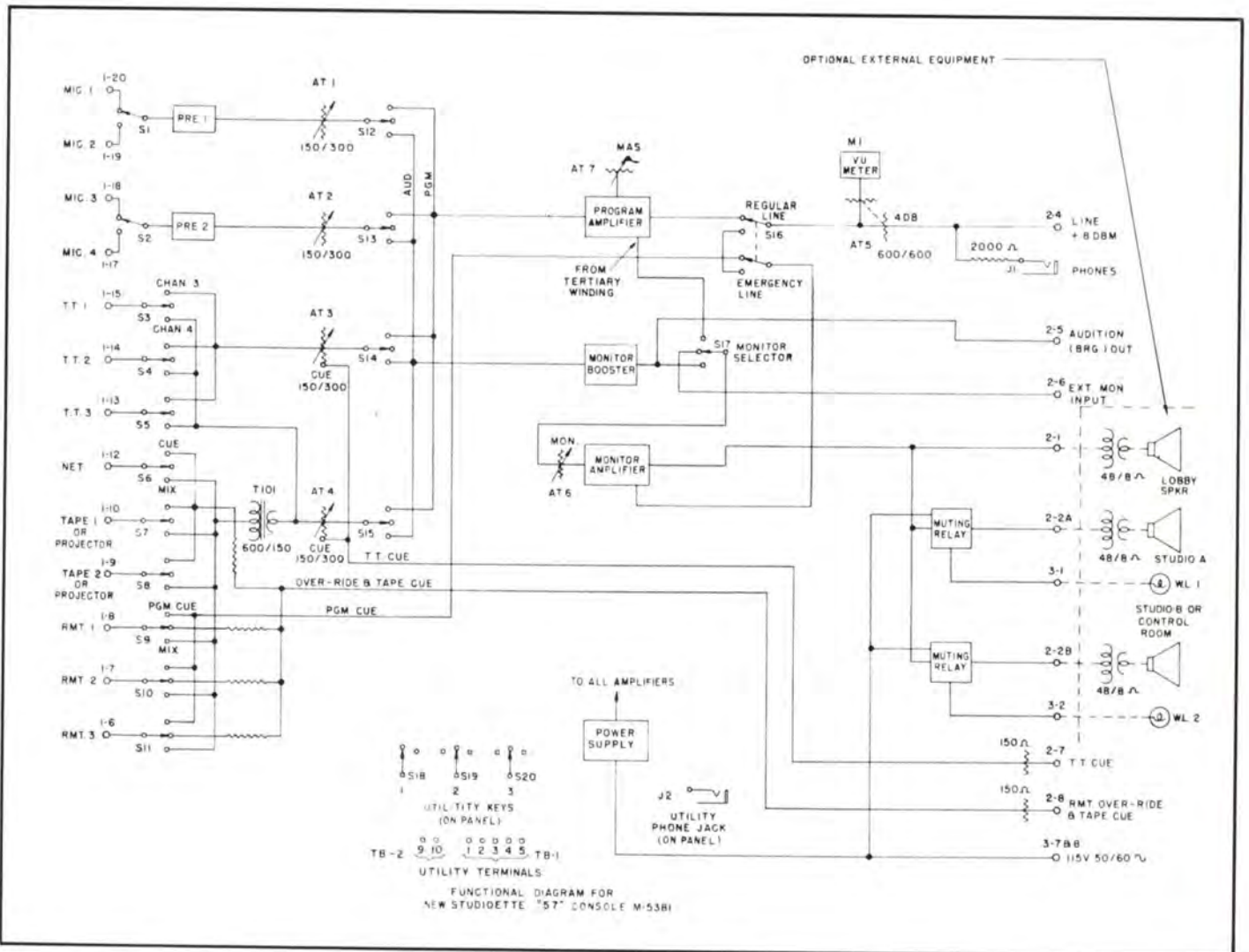

# TV-10 AUDIO CONTROL CONSOLE FOR TELEVISION



Here is a ten channel speech input system designed to handle large television productions yet versatile enough to accommodate the smallest without complexity. Ten mixing channels are key selected into two program buses, each with its own program amplifier. Each program bus has its own sub-master gain control. By key selection, any combination of channels may be faded as a group and the remaining combination faded as another group, or by the flip of a key, all may be faded together.

Ten or any lesser number of preamplifiers may be used. Six are standard equipment leaving four high level channels for projector, tape and turntable needs. However, the provision of seven unwired utility keys would permit switch control of all projectors, tapes and turntables into one channel, leaving nine with preamplifiers for microphone service.

Booster amplifiers for each program bus are inserted ahead of each sub-master gain control. Preamplifiers and booster amplifiers are on printed wiring boards for absolute uniformity.

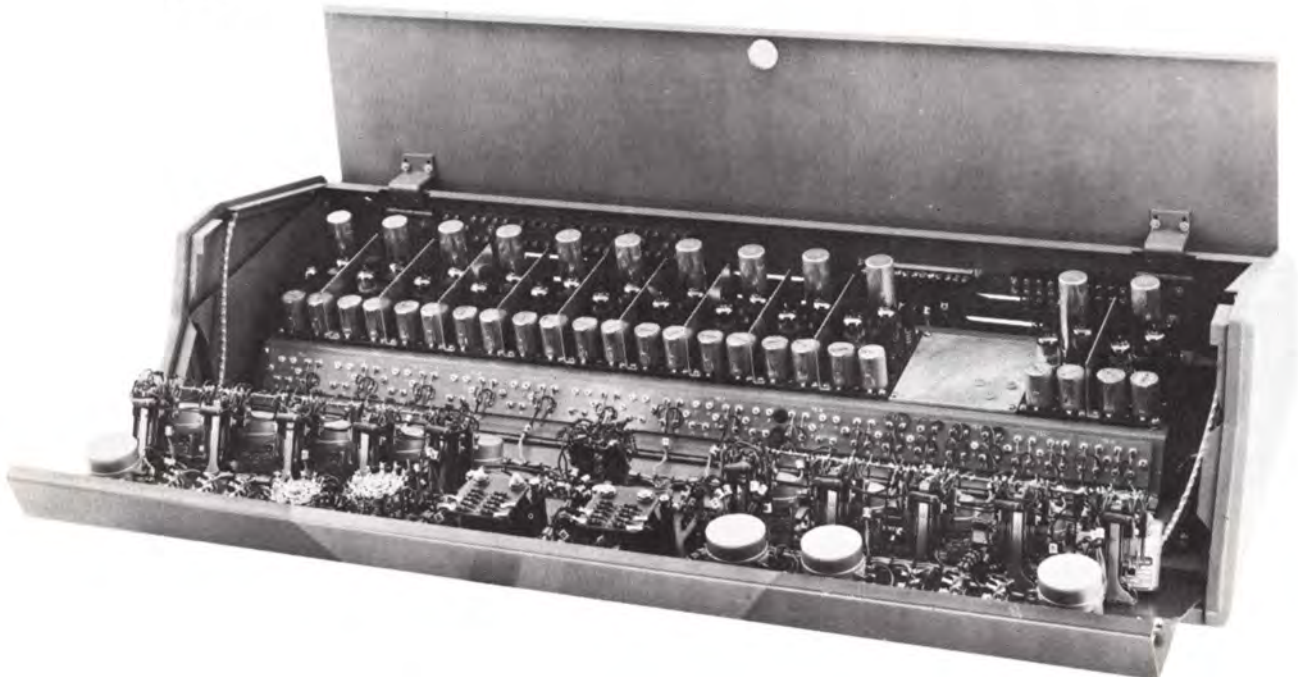

# TV-10 AUDIO CONTROL CONSOLE FOR TELEVISION

## OUTSTANDING FEATURES INCLUDE:

- Ten mixing channels, all with step attenuators.
- Mixer keys select into choice of two program buses, each bus controlled by sub-master gain control.
- Master gain selectable to either program bus or combined program buses for total fade.
- 10 position selector for complete preview of each of 10 mixing channels.
- 10 position monitor selector for monitoring: (1) program bus A, (2) program bus B, (3) combined program buses, (4) Line 1, (5) Line 2, (6) Utility Line, (7) Four utility circuits at user's discretion.
- Back panel mount dual standard 4" VU meters.
- Dual "plug-in" high gain program amplifiers.
- Booster amplifier for each program bus.
- 10 preamplifier capacity. 6 supplied as standard equipment.
- 10 watt low distortion monitoring amplifier.

Two regulated power supplies, one for program section and second for monitoring amplifier. Use of electronic regulator adds greatly to noise reduction as well as stability.

7 unwired utility keys for use at station's discretion. Adds 21 circuits, 4 headset jacks — 3 for output lines plus utility jack usually wired to intercom.

3 relays for warning light/speaker muting with knockouts for 2 more relays if needed.

Anodized lifetime escutcheons — no wear off of lettering — retains newness through years.

2 step functional design. Perfect over the top vision — only 7 1/2" high.

Instant serviceability. Hinged front panel, hinged inner chassis strip. Hinged cover.

No back of cabinet connections. All terminations inside for both shielding and convenience.

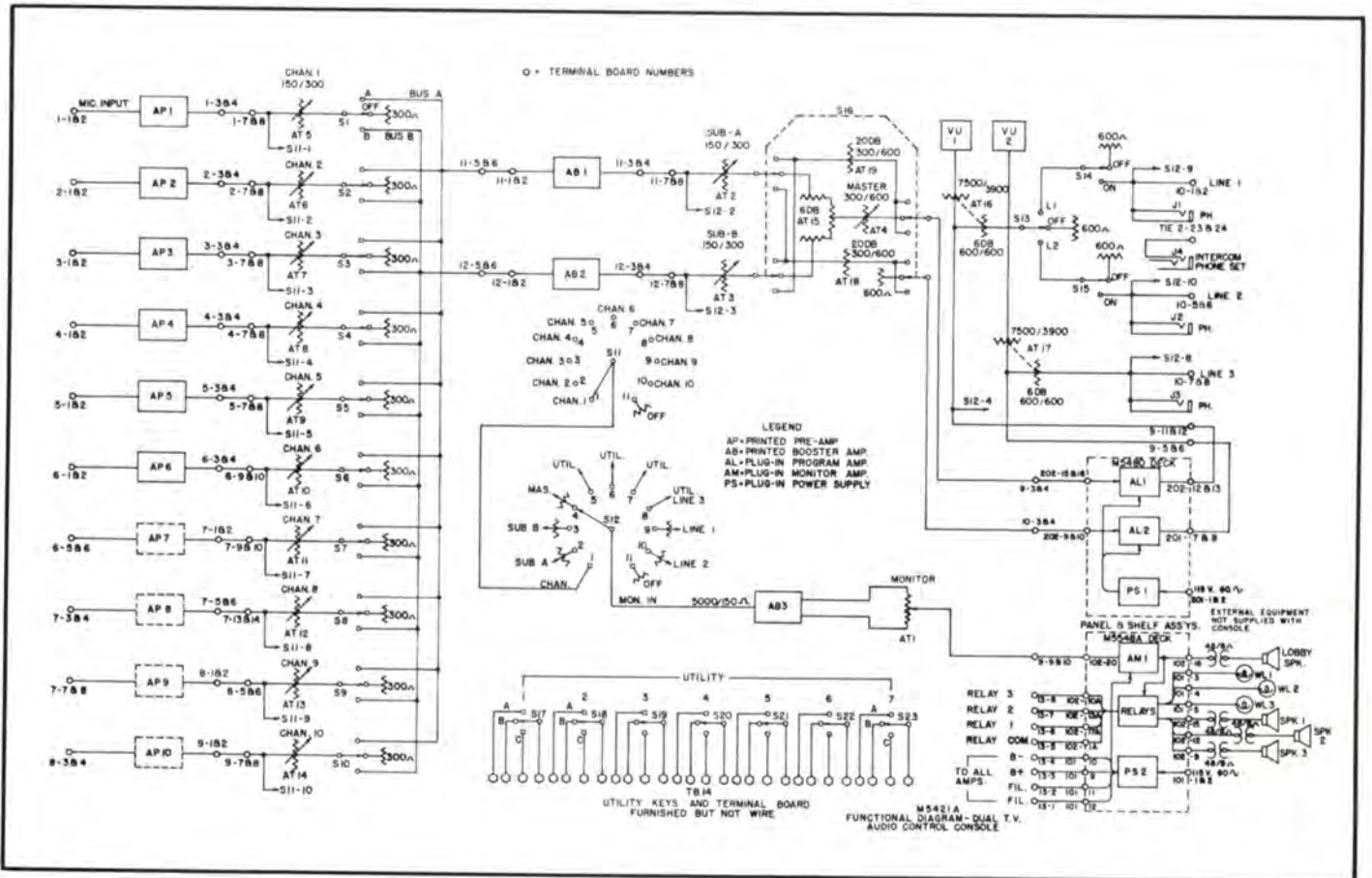



## TV-10 AUDIO CONTROL CONSOLE FOR TELEVISION

### SPECIFICATIONS ELECTRICAL

Microphone input to program line output (all channels):

GAIN: 106 db +2 db at 1000 cycles.  
 RESPONSE: +1.5 db, 30-15,000 cycles.  
 DISTORTION: 0.5% or less 50-15,000 cycles at +18 dbm output.  
 NOISE: 60 to 65 db below +8 dbm output with -60 dbm input.  
 CROSS-TALK: 65 db below +8 dbm at normal gain settings.\*

High level channels (less preamplifiers):

GAIN: 65 db +2 db at 1000 cycles.  
 RESPONSE: +1.5 db 30-15,000 cycles.  
 DISTORTION: 0.5% or less 50-15,000 cycles at +18 dbm output.  
 NOISE: 65 db below +8 dbm output with -10 dbm input.  
 CROSS-TALK: 65 db below +8 dbm at normal gain settings.\*

Monitoring amplifier:

GAIN: Provides maximum output with normal levels and control positions.  
 RESPONSE: +2 db 50-15,000 cycles.  
 DISTORTION: 1.5% or less 50-15,000 cycles at normal speaker levels, 3% or less at +38 dbm output (8 watts).  
 NOISE: 60 to 65 db below +30 dbm output at normal control settings.  
 CROSS-TALK: None.\*

\* Cross-talk is also governed by overall installations such as insertion of high and low level circuits in same house conduit.

### SPECIFICATIONS MECHANICAL

SIZE: Console, 39" long, 7 $\frac{1}{2}$ " high (lid down), 15 $\frac{1}{2}$ " deep.  
 FINISH: Medium gray hand rubbed with second tone of light gray. Escutcheons anodized black. Knobs black with color disc inserts. Panel and shelf units in medium gray hand rubbed.  
 WEIGHTS: Console, 50 lbs. Panel and shelf units with equipment, 80 lbs. Packed weight, 250 lbs. Cubage 16.  
 POWER: 105/125 volts, 50/60 cycles, 150 watts input with 6 preamplifiers, 170 watts input with 10 preamplifiers.

### OTHER SPECIFICATIONS

VU METERS: 2 supplied, standard 4" illuminated back panel mounted. Reads output each program amplifier at +8 VU.

TERMINATIONS: To inside rear of both console and panel and shelf units. No exposed terminations.

PATCH PANEL: Terminals with jumpers for insertion of patch jacks at all major circuits (see Block Diagram).

ATTENUATORS: Ten mixing attenuators, 20 steps of 2 db. All low impedance 150/250 ohms. Sub-master gain controls, 20 steps of 2 db. Master gain control, 20 steps of 2 db. Use of high impedance mixing is entirely avoided.

UTILITY KEYS: 7 keys (4 bottom center above jacks and 3 top left level) are supplied with terminal strips but unwired. Each key has 3 positions, or 7 keys may be wired to handle 21 low impedance circuits as desired by user. It is well to re-emphasize the patch panel facility (above) to fully determine the maximum flexibility of the TV-10 console.

TUBES: Preamplifiers (6), two 5879.  
 Booster amplifiers (2), two 5879.  
 Program amplifiers (2), one 5879, three 12AU7.  
 Monitor amplifier (1), two 5879, 6AQ5, one 12AU7.  
 Power supplies (2), two OA2, one 5V4G, 5879, 6080.  
 Total Tubes: (22) 5879, (7) 12AU7, (2) 6AQ5, (2) 5V4G, (2) 6080 and (4) OA2.

### ORDERING INFORMATION

TV-10 Speech Input Console complete with tubes, two regulated power supplies (one panel and shelf assembly, one drop-panel housing), dual program amplifiers, dual power supplies, relay unit and monitoring amplifier ..... M-5421A  
 Extra preamplifiers with tubes ..... M-5304  
 Spare tube complement for TV-10 Console .. TK-295

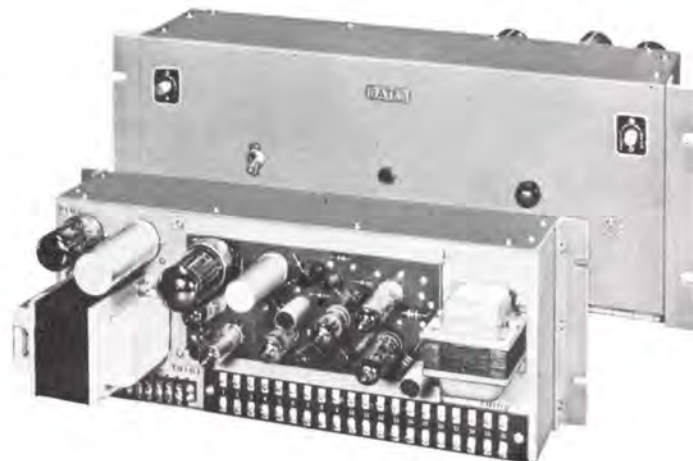
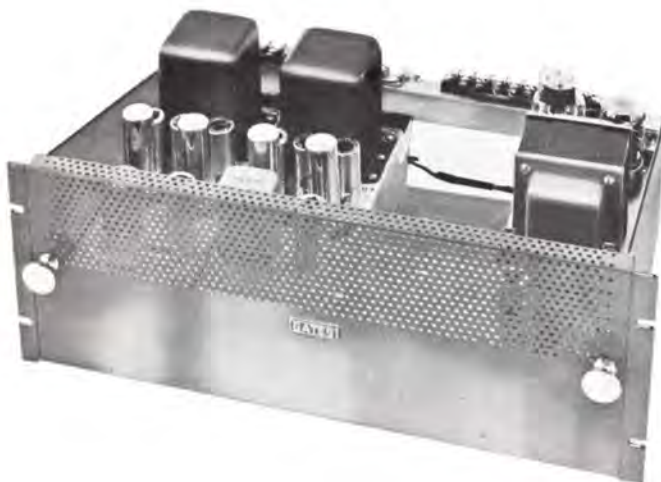

## MASTER PRESET CONTROL CONSOLE

Large studio installations involving many control points and several outgoing circuits are usually best suited to master control. As technical requirements vary from one installation to another, no particular attempt is made to offer the broadcaster a standardized type of master preset equipment. However, by reason of the generous number of preset installations that have been designed and furnished by Gates, it is relatively simple to adopt standard procedures to the custom requirements of the customer. Gates engineers will gladly confer at any time with those interested in more complex studio equipment requirements.

The preset unit, illustrated herein, is based around a parallel preset relay system. Divided into three sections, ten relays in each unit are employed for program switching and are preset from the front panel. These relays are



then controlled by a master relay. A double light bank indicates the preset circuit. Red is "On Air". Green is "Preset". The lever key locks up to "Master" and is non-locking down to "Operate".

It will be noted that though complete in every detail, the space requirements are held to a minimum as can be observed by comparing the 4" VU meter size to the total width and height. Prices on Preset equipment will be gladly supplied in accordance with station needs.

## MOBILE SOUND EFFECTS CONSOLE

In program production, the sound effects console plays a very important part. The CSE-9 sound effects console has been designed to provide the sound department with a unit having every modern feature, handling ease, and the same quick serviceability, in case of trouble, that will be found in any modern up-to-date speech input system.

Six input circuits, two for microphones and four for pickups, feed into a program amplifier as well as a power amplifier. Each of these six channels has ladder attenuators with cue position at infinity. This cue output feeds into a split headphone arrangement. Four circuits are handled: (1) program cue, (2) sound effects cue, (3) sound effects out, and (4) director's cue. The two microphone channels are provided with PRE-4 plug-in preamplifiers, and the four pickup channels are provided with PRE-3 preamplifiers with high and low roll-off. In addition to individual equalization of each pickup, a master sound effects filter is provided, with complete high and low roll-off. — It can be said with accuracy that nearly any type of response curve may be obtained to provide the effect desired.



Cabinet is rigidly constructed of light metals to assure easy mobility on the silent rubber-tired wheels that may be locked in place for permanence. Front control panel hinges down for servicing. When not in use, the plexi-glass copy stand pulls up and over the turntables and control panel.

SIZE OF CSE-9 SOUND EFFECTS CONSOLE: 60" wide, 27½" deep, 48" high overall.  
 POWER: 115 volts, 50/60 cycles, approximately 400 watts.  
 WEIGHT PACKED: 400 lbs. Cubage, 75.

### ORDERING INFORMATION

Sound effects console complete with tubes, less loudspeaker ..... CSE-9  
 100% spare tube complement ..... TK-155

# CB-500 TRANSCRIPTION TURNTABLE

16 INCH



Today's demands in the broadcasting of transcribed music have automatically created new performance demands on transcription turntables. Stereo broadcasting places greater emphasis on the vertical rumble content of the turntable. Greatly improved standard monaural recordings of the LP variety are equally quick to emphasize lateral rumble. To meet these exacting demands, Gates offers commercial transcription turntables with an entirely new design principle. The result is a new low in rumble content and with many other performance specifications being substantially upgraded to fit today's needs and tomorrow's absolute demands.

Heart of the CB-500 design is a drive hub which is part of the machined turntable platter and about one-half the radius of a 45 RPM disc. The single idler wheel for all three speeds is floating and self-aligning. A 600 RPM hysteresis synchronous motor with 3-speed pulley engages the idler wheel to the inner hub (see Fig. 2). The combination of the lower speed motor, one-third that of other

models, and the driver section (hub) being located inside the playing surface, reduces the rumble so remarkably that production line turntables now exceed earlier laboratory standards.

Some rumble or noise reduction has been accomplished before but with the sacrifice of up-to-cue speed. The CB-500 turntable will come up to speed at 33-1/3 RPM in 1/8 turn, and at 45 RPM in 1/6 turn. This is equivalent or superior to other recognized quality turntables which usually have higher rumble content.

Speed change is exact and functionally correct. All 3 speeds shift across a single indexed plate. A mercury type start-stop switch illuminates when on. The operator may start his turntable in three modes: (1) the silent, illuminated and functionally correct rocker arm start switch, (2) by moving the index lever to the speed designed, or (3) slip cueing. Any method is smooth and free of jumping or grabbing.

**CB-500 TRANSCRIPTION TURNTABLE**



The cut-away illustration exemplifies the fine machining and workmanship. Chrysler oilite bearings are used at all bearing points including the large center spindle bearing. Speed shift linkages are through monoball self-aligning bearings for smooth, silent and trouble-free operation. There are no belts, planetary drives or gear trains to wear.

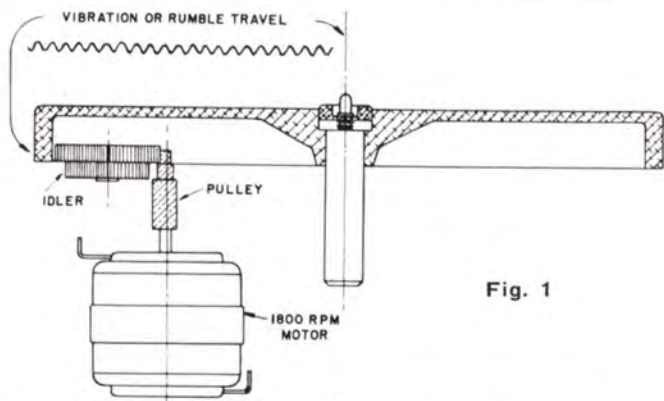

Fig. 1

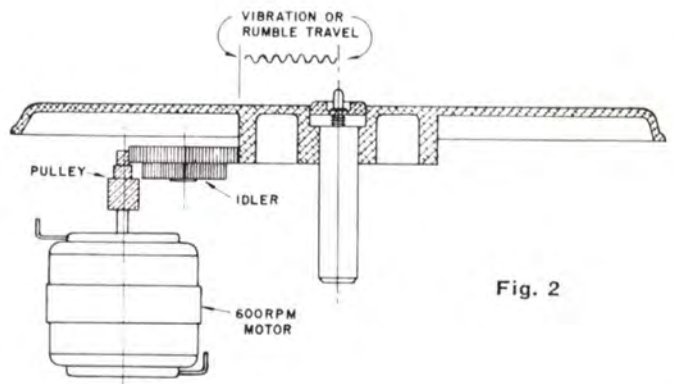

Fig. 2

Heretofore, all rim drive turntables, as the word implies, drove against the outer rim of the platter. Vibration, or what is usually called rumble, was returned to the center spindle or bearing across the entire playing surface of the platter. This type drive required an 1800 R.P.M. motor for proper speed ratios. The greater the motor speed, the greater the vibration, no matter how slight it might be. Likewise, higher motor speeds raise the audio frequency of this vibration or rumble.

In both the 16 and 12 inch Gates turntables, the drive is against a solid inner hub, away from the usable playing surface of the platter. Likewise, any minute vibration or rumble is pushing against the center bearing instead of pulling away, such as in outer rim drive turntables. With this exclusively new drive system, a 600 R.P.M. hysteresis synchronous motor is used. Lower motor speed assures lower vibration or rumble. The lower speed substantially drops the audio frequency of this much lower motor vibration to where much of the rumble is in the sub-audible spectrum.

## CB-500 TRANSCRIPTION TURNTABLE SPECIFICATIONS

CHASSIS SIZE: 21<sup>1</sup>/<sub>4</sub>" x 21<sup>1</sup>/<sub>4</sub>" x 1-5/16".  
 MOTOR HANG BELOW BOTTOM OF CHASSIS: 47/8"  
 CONSTRUCTION: Both platter and base of machined aluminum.  
 FINISH: Gray enamel with escutcheon in black and turntable platter cover in heavy green felt.  
 PLATTER SIZE: 17".  
 STROBOSCOPE: Inbuilt on platter for all 3 speeds.  
 CENTER SPINDLE: Spring locking type, snaps up for 45 RPM hub, locks down for smaller spindle records.  
 CENTER BEARING: 1" diameter hardened steel rotates in Chrysler oilite bearing.  
 MOTOR: Hysteresis synchronous, single phase, 600 RPM with 2<sup>1</sup>/<sub>2</sub> mfd. running capacitor and 40° C temperature rise.  
 CUE ALLOWANCE: At 33-1/3 RPM, 1/8 turn.  
                   At 45 RPM, 1/6 turn.  
                   At 78 RPM, 3/4 turn.

NOISE OR RUMBLE:  
     At 33-1/3 RPM, rated -45 db., capable -50 db.  
     At 45 RPM, rated -40 db., capable -45 db.  
     At 78 RPM, rated -35 db., capable -39 db.  
 WOW: Rated 0.15% at 33-1/3 RPM, capable .08%.  
 FLUTTER: Rated 0.07% at 33-1/3 RPM, capable .05%.  
 MOTOR START: Rocker type mercury switch. Push front for "ON" and back for "OFF". Switch illuminates when on.  
 IDLER WHEEL: Special shear action neoprene, self-aligning.  
 SPEED CHANGE: To 33-1/3, 45 or 78 RPM by single indexed lever control.  
 POWER: 115 volts, 60 cycles, 35 watts. (50 cycle available, see below.)  
 SHIPPING WEIGHT: 54 (net weight, 34 lbs.)  
 CUBAGE: 3 cu. ft.

### ORDERING INFORMATION

Transcription turntable chassis only, for 115V, 60 cycles ..... **CB-500**  
 Transcription turntable only, for 115V, 50 cycles ..... **CB-500-50**

Gates purchased a sample of all leading transcription turntables, both 16" and 12". All tests were made under identical conditions, on the same floor location, the same mounting, the same pick-up, the same test equipment, etc.

fair but give any non-Gates turntable the benefit of the doubt. To be entirely fair, the Gates turntable tested was selected at random. The fairness of these tests is indicated by the fact that all but two of the turntables tested met NAB requirements. (Manufacturer's specifications were taken either from catalogs or instruction books, as the case may be.)

The engineer making these tests was instructed to not only be

### TEST COMPARISONS OF LEADING FRICTION DRIVE TURNTABLES

	GATES CB500	COMPANY "A"-16" T.T.	COMPANY "B"-16" T.T.	COMPANY "C"-16" T.T.	COMPANY "D"-16" T.T.	COMPANY "E"-12" T.T.	COMPANY "F"-12" T.T.	COMPANY "G"-12" T.T.	N. A. B. SPECS.
RUMBLE AT 33 <sup>1</sup> / <sub>3</sub> R.P.M.	-50 Db.	-35 Db.	-32 Db.	-34 Db.	-39 Db.	-44 Db.	-34 Db.	-37 Db.	35 Db. BELOW 7 CM/SEC. SIGNAL AT 1000 CYCLES
RUMBLE AT 45 R.P.M.	-45 Db.	-37 Db.	-34 Db.	-32 Db.	-38 Db.	-44 Db.	-32 Db.	-36 Db.	
RUMBLE AT 78 R.P.M.	-39 Db.	-22 Db.	-32 Db.	-28 Db.	-35 Db.	-41 Db.	-34 Db.	-30 Db.	
PLATTER TURNS TO FULL SPEED	33 <sup>1</sup> / <sub>3</sub> R.P.M.	1/8	1/6	1/8	1/8	1	1-1/4	1/6	NO APPARENT SPECIFICATION FOR THIS IMPORTANT FUNCTION
	45 R.P.M.	1/6	3/8	1/4	1/6	1/4	1-1/4	2-1/2	
	78 R.P.M.	3/4	5/8	1	3/8	3/4	2-1/2	3-1/4	
WOW 33 <sup>1</sup> / <sub>3</sub>	0.08%	0.04%	0.1%	0.15%	0.07%	0.15%	NOT TESTED BUT CONSIDERED EXCELLENT	0.2%	0.2% BOTH WOW AND FLUTTER. TESTED AT 33 <sup>1</sup> / <sub>3</sub> R.P.M. AS HIGHER SPEEDS WOULD NORMALLY INDICATE IMPROVED MEASUREMENTS
FLUTTER 33 <sup>1</sup> / <sub>3</sub>	0.05%	0.04%	0.07%	0.15%	0.04%	0.07%	0.02%		

#### BELOW IS WHAT EACH MANUFACTURER CLAIMS IN HIS PUBLISHED CATALOGUE LITERATURE

	GATES CB500	COMPANY "A"-16" T.T.	COMPANY "B"-16" T.T.	COMPANY "C"-16" T.T.	COMPANY "D"-16" T.T.	COMPANY "E"-12" T.T.	COMPANY "F"-12" T.T.	COMPANY "G"-12" T.T.	NOTE:
33 <sup>1</sup> / <sub>3</sub>	-45 Db.	STATES -50 Db. WITHOUT DEFINING SPEED	STATES -50 Db. WITHOUT DEFINING SPEED	STATES APPROX. -40 Db.	-35 Db.	STATES -53 Db. WITHOUT DEFINING SPEED	STATES EXCEEDING NAB SPECS BY GOOD MARGIN	STATES ALMOST NON-EXISTANT	NOTE: ALL TESTS MADE UNDER IDENTICAL CONDITIONS AND WITH AMBIENT NOISE -50 Db. OR BETTER.
45	-40 Db.				-35 Db.				
78	-35 Db.				-35 Db.				
PLATTER TURNS TO FULL SPEED	33 <sup>1</sup> / <sub>3</sub>	1/8	1/4	1/8	STATES APPROX. 1/2 TURN	DOES NOT SPECIFY	DOES NOT SPECIFY	DOES NOT SPECIFY	
	45	1/6	1/4	DOES NOT SPECIFY					
	78	3/4	3/4	1/2					
WOW 33 <sup>1</sup> / <sub>3</sub>	0.15%	STATES BETTER THAN N. A. B.	DOES NOT SPECIFY	DOES NOT SPECIFY	0.2 to 0.25%	BETTER THAN N. A. B.	DOES NOT SPECIFY	LESS THAN 0.2%	
FLUTTER 33 <sup>1</sup> / <sub>3</sub>	0.07%							LESS THAN 0.05%	

# CB-510 - CB-525 TRANSCRIPTION TURNTABLES

16 INCH



Shown above is the CB-510 complete operating transcription turntable. Includes CB-500 low noise chassis, GR-16 viscous damped pickup arm, twin flip over 1 mil and 2½ mil reluctance cartridge, 3-position variable equalizer to NAB, RIAA and high frequency roll off curves and M-5235 preamplifier with self-contained power supply. Output: 150/160 ohms at approximately -20 db.



Above is the CB-510 turntable with platter removed, showing the shift mechanism and self-contained preamplifier. The preamplifier bolts to the under side of the turntable chassis and has its own self-contained selenium power supply.



Shift speeds to 78, 45 or 33-1/3 RPM by simply moving shift lever to the desired index point — then touch the switch to either start or stop. Complete one-hand operation leaves the other hand free for cueing or control boards.



CB-525 and CB-525A turntable. This is the same as the CB-510 turntable but with the CAB-6 floor cabinet added.

CAB-6 cabinet. Has adjustable leveling screws, full size rear door. Made of 5-ply seasoned cabinet maker's birch, sealed and beautifully finished in gloss gray and black. Size: 21¼" wide, 21¼" deep, 29½" high plus 1" for leveling screws. For CB-500 chassis or CB-510 complete turntable.

## ORDERING INFORMATION

- Complete transcription turntable including self-contained preamplifier, power supply, CB-500 chassis, 3-position equalizer, pickup arm and dual sapphire stylus ..... CB-510
- Complete transcription turntable, same as above but with dual diamond stylus ..... CB-510A
- Complete transcription turntable in cabinet, consisting of Model CB-510 above, mounted in CAB-6 cabinet ..... CB-525
- Complete transcription turntable in cabinet, consisting of Model CB-510A above, mounted in CAB-6 cabinet ..... CB-525A
- Cabinet only for CB-500 chassis ..... CAB-6
- Step-down transformer, primary 230V, 50/60 cycles, secondary 115V ..... M5830

## CB-4 HORSESHOE DESK

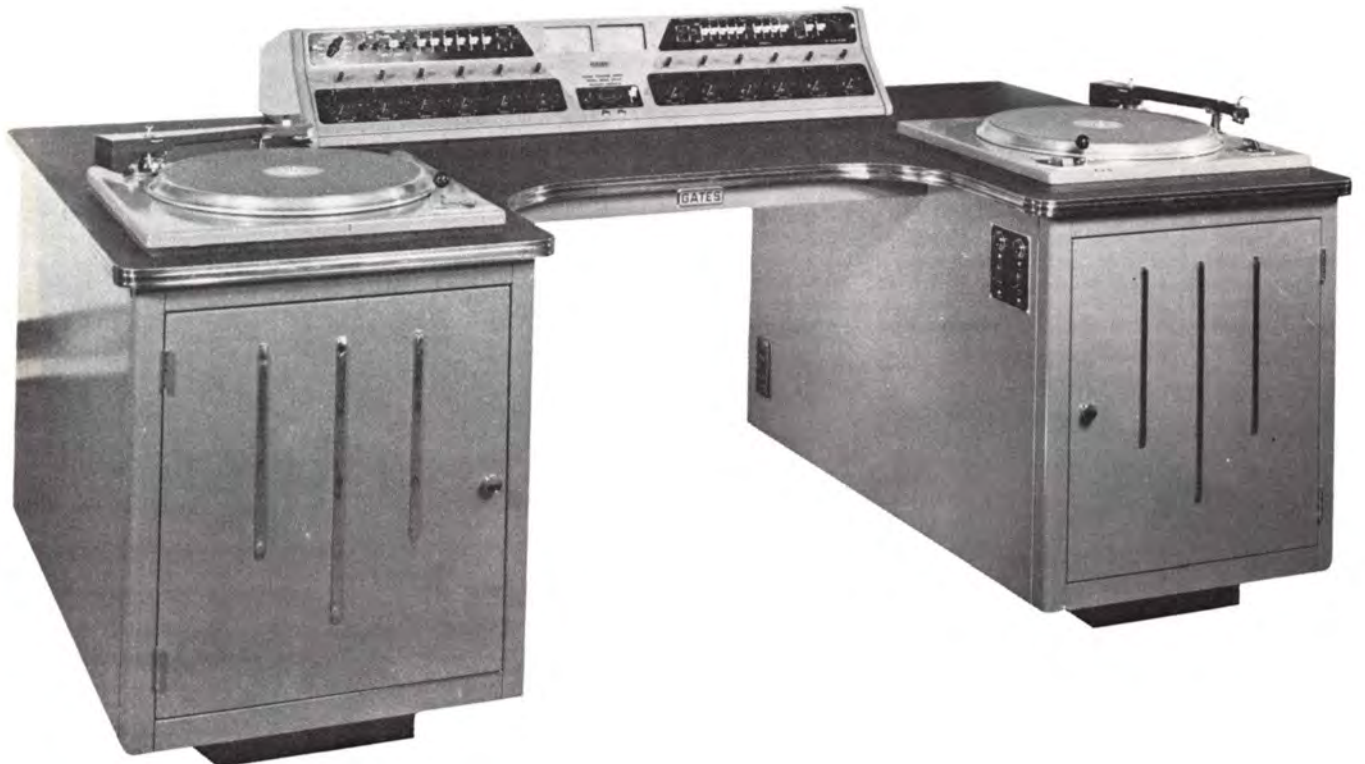

Even though wonderfully attractive, the CB-4 desk is even greater in its functional usefulness. Here the turntables are on each side of the operator at the correct arm's length for relaxed operation.

Right and left wings are big and roomy. Designed with enough width to hold 19" rack panel equipment, but used as frequently for the tape and disc storage. Actually there is more than enough room for both. Here, indeed, is a show piece both in massive, eye-catching appearance and engineering correctness. Many broadcasters found the slight extra cost paid big dividends in better broadcasting through operator's pride in knowing he has the finest.

## CB-4 HORSESHOE DESK

### SPECIFICATIONS

**CONSTRUCTION:** Top of seasoned 7-ply selected birch covered with double thick black linoleum. Top edge is banded with a chrome style band fitting flush. Top is secured to two end wings having inside dimension of 22½" wide, 25" high and 45" deep. Each wing has a removable rear door and hinged front door. Wings are of seasoned plywood (selected birch) and will not warp or check. Each wing will accommodate 21" of 19" rack panel space. Wings may be used for disc or tape storage on one or both sides.

In wired models the desk is cut out for Gates CB-500 turntables on each side. Mercury type TT motor starting switches are provided on the inside of each wing. An additional master switch is provided on the inner right wing. Wiring is terminated to the rear base.

**FINISH:** Medium gray smooth lacquer presents metal finish. Use of wood is for best turntable performance as well as appearance. Top is black. Trim is chrome.

**OTHER ACCOMMODATIONS:** Most types of turntables and nearly all types of speech input consoles may be used with the CB-4 desk. Size is such that consoles of substantial width and depth may be employed without sacrifice of arm room or serviceability of console.

**SIZE:** Height 29", Width 84", Depth 48".

**WEIGHT:** Packed, 390 lbs.

**CUBAGE:** 120.



### CB-4 DESK COMBINATIONS

Desk only with cutouts for CB-500 turntable, switches and wired .....	CB-4M
Desk only without cutouts or wiring .....	CB-4
Desk with two CB-510A turntables wired, includes pre-amplifiers .....	CB-4N
Desk with CB-500 turntables, Gray 106-SP arms, Gray 602 C equalizer, dual cartridge, 1 mil. and 2½ mil. diamond stylus, wired .....	CP-4P
Includes CB-4N listed above with Gatesway speech input console .....	CP-4R
Includes CB-4P listed above with Gatesway speech input console .....	CP-4S

**NOTE:** CB-4 desks may be used with any Gates Console. Above illustration shows CB-4 with Dualux speech input system. Select desk combination of your choice and add console price for total selling price.



# 12-INCH TRANSCRIPTION TURNTABLES

Models CB-77, CB-88, CB-880, CB-99



CB-77



CB-88



CB-880

**MODEL CB-880:** This model consists of the CB-88 complete turntable mounted in the CAB-8 single chassis cabinet listed at right.

Here is a new professional 12-inch transcription turntable, built identical to the companion CB-500 16-inch model. In the new CB-77 chassis will be found the same inner hub drive system, the same speed change system, the same rocker arm, illuminated off-on switch . . . the only difference is a reduced size, affording broadcasters a more compact turntable arrangement in today's busy control room.

Rumble is at a new low for either broadcast or high fidelity standards, while wow and flutter far exceed acceptable standards for high-quality commercial broadcasting.

Chassis size is 16 inches square. Now one, two or even a dozen turntables may be closely grouped. Along with the CB-77 chassis are several complete models with pickups and preamplifiers as well as new 12-inch cabinet styles.

**MODEL CB-77:** Chassis only, ready to attach pickup arm of your choice. For 33-1/3, 45 and 78 RPM with fast pickup-to-speed and as low as -50 db. rumble in most instances.

**MODEL CB-88:** Complete transcription equipment. Includes CB-77 chassis, M5235 preamplifier listed Page 139, dual viscous damped Gray arm, twin flip-over 1 mil. and 2 1/2 mil. reluctance cartridge with your choice of sapphire or diamond styli, 3-position equalizer to NAB, RIAA and high frequency roll off curves and self-contained selenium power supply (part of preamplifier).

**MODEL CAB-8 CABINET:** Designed to house the CB-77 chassis or CB-88 complete turntables. 16 1/8" wide, 16 1/8" deep and 30" high with leveling screws. Over-all maximum height with chassis mounted is 32 3/8". Built of cabinet maker's birch with corner supports of steel and finished in two-tone gray and black. Back door removable for servicing.

**CB-77, CB-88, CB-880, CB-99 12-INCH TRANSCRIPTION TURNTABLES**

**CB-77 SPECIFICATIONS**

- CHASSIS SIZE: 16" x 16" x 1-5/16".
- MOTOR HANG BELOW BOTTOM OF CHASSIS: 5 3/4".
- CONSTRUCTION: Both platter and base of machined aluminum.
- FINISH: Gray enamel with escutcheon in black and turntable platter cover in heavy green felt.
- PLATTER SIZE: 13 3/8".
- STROBOSCOPE: Inbuilt on platter for all 3 speeds.
- CENTER SPINDLE: Spring locking type, snaps up for 45 RPM hub, locks down for smaller spindle records.
- CENTER BEARING: 1" diameter hardened steel rotates in Chrysler oilite bearing.
- MOTOR: Hysteresis synchronous, single phase, 600 RPM with 2 1/2 mfd. running capacitor and 40° C temperature rise.
- CUE ALLOWANCE: At 33-1/3 RPM, 1/8 turn.  
At 45 RPM, 1/6 turn.  
At 78 RPM, 3/4 turn.
- NOISE OR RUMBLE:
  - At 33-1/3 RPM, rated —45 db., capable —50 db.
  - At 45 RPM, rated —40 db., capable —45 db.
  - At 78 RPM, rated —35 db., capable —39 db.
- WOW: .15% maximum, capable .08%.
- FLUTTER: .07% maximum, capable .05%.
- MOTOR START: Rocker type mercury switch. Push front for "ON" and back for "OFF". Switch illuminates when on.
- IDLER WHEEL: Special shear action neoprene, self-aligning.
- SPEED CHANGE: To 33-1/3, 45 or 78 RPM by a single indexed lever control.
- POWER: 105-125 volts, 60 cycles, 35 watts, (50 cycle model available, see below).
- SHIPPING WEIGHT: 40 lbs. (net weight, 30 lbs.)



MODEL CB-99: Consists of two complete CB-88 turntables mounted in the dual cabinet, Model DTT-2, listed below. Where desired, the sloping front may be used for controls or switches at the user's discretion.

MODEL DTT-2 DUAL CABINET: Made of 1/16" cold rolled stretcher level furniture steel with bottom of 3/4" plywood to omit resonance. Front slopes where broadcaster desires to add controls for disc jockey models, etc. Finish gloss gray. Size: 37 1/8" wide, 19 3/4" deep and 33" high. Accommodates two CB-77 chassis or CB-88 complete turntables.

**ORDERING INFORMATION**

- 12-inch transcription turntable chassis only, 60 cycles ..... CB-77
- 12-inch transcription turntable chassis only, 50 cycles ..... CB-77-50
- Complete 12-inch transcription turntable including self-contained preamplifier, power supply, CB-77 chassis, 3-position equalizer, pickup arm and dual sapphire stylus ..... CB-88
- Complete transcription turntable, same as above but with diamond stylus ..... CB-88A
- Complete 12-inch transcription turntable in cabinet, consisting of Model CB-88 above, mounted in single chassis floor cabinet ... CB-880
- Complete transcription turntable in cabinet, consisting of Model CB-88A above, mounted in single chassis floor cabinet .... CB-880-A
- Two complete CB-88 transcription turntables above, in dual 12-inch turntable floor cabinet ..... CB-99
- Two complete CB-88A transcription turntables above, in dual 12-inch turntable floor cabinet ..... CB-99A
- Single chassis cabinet only ..... CAB-8
- Dual chassis cabinet only ..... DTT-2

# TURNTABLE ACCESSORIES



**NEW GRAY ARM  
WITH DUAL  
VISCOUS-DAMPING**

This new Gray micro-balanced tone arm has sealed viscous-damping on both vertical and horizontal pivots for better tracking and lower resonance. It is completely statically balanced around the vertical pivot, providing maximum tracking stability. Designed for records up to 12-inches in diameter. Stylus force adjustable from zero to 15 grams, thus eliminating cartridge weights. Can be used with all popular cartridges. Use with 12" turntables only, such as CB-77.

Gray Viscous Damped Arm ..... Model 212



**GRAY 108-C  
VISCOUS-DAMPED ARM**

Considered one of the finest professional tone arms in broadcasting, the Gray 108-C handles 16" discs or smaller. Viscous Damping makes it difficult for the arm to jump or skip across the record. Tone arm has maximum immunity to shock or vibration from speakers at low frequencies. Also features perfect tracking and adjustable dampening. Use with GE triple or single play reluctance pickup heads. Use with 16" turntables such as Gates CB-500.

Gray Viscous Damped Arm ..... Model 108C



**GR-16  
VISCOUS-DAMPED ARM**

This excellent tone arm employs the floating action viscous damped principle. Supported at one point by needle bearing and jeweled pivot in ball and

socket assembly in silica oil dampening fluid. Has variable side adjustment for exact stylus pressure. Accommodates all reluctance cartridges including triple plays. For 17" discs or less. Used in CB-510 and CB-525 models.

Viscous Damped Arm ..... Model GR-16



**GRAY EQUALIZER**

Four-position equalizer for use with any low impedance pick-up cartridge and provides these curves: (1) NAB, (2) intermediate, (3) roll off, and (4) flat response. Output impedance 150/250 ohms. Supplied as illustrated with etched dial plate and knob. Used with low impedance cartridges only.

Transcription Pickup Equalizer ..... Model 602-C

## GE TYPE VR-2 PICKUP CARTRIDGES

Response 20-20,000 cycles with output of 22 MV at 10 CM/Sec. Tracking pressure only 4 grams. Has replaceable clip in stylus. Use high impedance type with Gates M-5235 equalized amplifier and Gates M-5530 preamplifier.

### High Impedance VR-2 Triple Play (turnover cartridge)

Sapphire .001" and sapphire .003" .....	4G050
Diamond .001" and sapphire .003" .....	4G052
Diamond .001" and diamond .003" .....	4G053

### High Impedance Single Stylus VR-2

Sapphire .003" .....	4G-040
Sapphire .001" .....	4G-041
Diamond .003" .....	4G-061
Diamond .001" .....	4G-063

### Low Impedance VR-2 Triple Play (turnover cartridge)

Sapphire .001" and sapphire .0025" .....	4GD-01S02S
Diamond .001" and sapphire .0025" .....	4GD-01D02S
Diamond .001" and diamond .0025" .....	4GD-01D02D

### Low Impedance VR-2 Single Stylus

Diamond .001" .....	4GS-01D
Diamond .0025" .....	4GS-02D
Sapphire .001" .....	4GS-01S
Sapphire .0025" .....	4GS-02S

### Replacement Styli for VR-11

Sapphire .001" .....	4G-01S
Sapphire .0025" .....	4G-02S
Sapphire .003" .....	4G-03S
Diamond .001" .....	4G-01D
Diamond .0025" .....	4G-02D
Diamond .003" .....	4G-03D

### Replacement "Clip in Styli" (for old RPX cartridges)

Sapphire .001" .....	RPJ-01S
Sapphire .0025" .....	RPJ-02S
Sapphire .003" .....	RPJ-03S
Diamond .001" .....	RPJ-01D
Diamond .0025" .....	RPJ-02D
Diamond .003" .....	RPJ-04D

### Single Tip Replacements for RPX, 040, 041, 061, 063 cartridges

Sapphire .001" .....	RPJ-005
Sapphire .0025" .....	RPJ-006
Sapphire .003" .....	RPJ-001
Diamond .001" .....	RPJ-004
Diamond .0025" .....	RPJ-003
Diamond .003" .....	RPJ-002

### Miscellaneous

Adaptor for using new VR cartridges in old GE-A1-501 arms .....	A1-504
Replacement parts kit for VR-11 cartridges .....	RKP-009B

## M-5235 EQUALIZED PREAMPLIFIER

A specially designed 3-stage, high gain preamplifier with self-contained selenium power supply and external 3-position filter with escutcheon plate for mounting on turntable chassis. Filter has NAB, RIAA and high frequency roll off curves for all standard records and transcriptions used today. Output level -10 dbm. Should be used with high impedance reluctance cartridges or similar such as 4G050, 4G052, or 4G053, listed page 138.

### SPECIFICATIONS

- INPUT IMPEDANCE:** For high impedance standard cartridges at essentially 12 mv. or lower.
- OUTPUT IMPEDANCE:** 150/250 or 500/600 ohms, balanced.
- OUTPUT LEVEL:** -10 dbm with normal level -20 dbm. High impedance termination also available, unbalanced.
- RESPONSE:** To NAB, RIAA and HF roll off curves.
- NOISE:** 55 db below -20 dbm, output or absolute noise -75 db.
- DISTORTION:** 1% or less 50-15,000 cycles.
- TUBES:** 2 each 12AX7 with selenium rectifier.
- SIZE:** 9" long, 3 3/8" wide, 3" above chassis and 2 1/4" below chassis.
- FINISH:** Gray.
- POWER:** 115 volts, 50/60 cycles.



### ORDERING INFORMATION

- Preamplifier with equalizer and tubes ..... M-5235  
 Spare 100% tube kit ..... TK-225

## M-5530 PREAMPLIFIER



Designed for all modern day, low level, pickup/equalizer systems and low impedance cartridges. When used with equalizers such as the 602-C, listed on Page 138, provides ample gain for good center-position mixing attenuator operation. Has 3 audio stages and self-contained power supply. Gates firm grip printed wiring (not printed circuit) assures 100% uniformity where several amplifiers are used in a system. Chassis includes gain control, fuse and barrier terminations. As this amplifier is also a superb remote microphone amplifier, a knock-out for a Cannon XL3-13 connector is provided on one side. Mounts nicely in base of turntable cabinet such as the CAB-6 or CAB-8, or on back of a standard 19" x 7" rack panel. For complete description, see page 170.

### ORDERING INFORMATION

- All-purpose amplifier complete with tubes ..... M-5530  
 Spare 100% tube kit for above ..... TK-280

## CUE — STA-LEVEL PATCH CABINET



Here are the three most used control room accessories packaged in a neat cabinet for wall or desk mounting. Top unit is the Gates Uni-Que cueing amplifier with inbuilt loudspeaker and 10-position input switch as described on Page 161. Center unit is the famous "Sta-Level" to provide constant program level to the transmitter line and listed on Page 156. The double jack panel will accommodate those extra circuits that are part of every broadcasting operation. Cabinet size: 20 1/2" wide, 11 3/4" high and 15" deep. Finish is in medium gloss gray.

### ORDERING INFORMATION

- Cue — Sta-Level Patch Cabinet, with tubes .... M-5635

# SPOT TAPE RECORDER

Model ST-101



101 announcements, jingles, themes, station breaks, featurettes and any other program content, up to 90 seconds duration each, including music of the highest broadcast standards — all on one tape 13" wide. Move the index lever to the spot your log calls for, push the start button and you are airing announcements that are flawless by reason of advanced rehearsal, multiple voices, background effects and themes. When complete, the tape automatically reverses and then cues up for split-second airing of the next spot. Erase any track not needed and record a new one as schedules change. The adjacent tracks are not affected.

"Spot Tape" sells for your customers and becomes a major business builder for any broadcasting station, radio or TV. The alert program director will be quick to recognize the scores of new broadcasting methods possible with Spot Tape, otherwise impossible except with the entire capable announcing staff on duty from sign-on to sign-off. All day long, Spot Tape is selling for you and your customers through highest level programming. While Spot Tape is operating, your production staff is carefully

planning new and better ways for tomorrow's or next week's presentation.

"Spot Tape" is a Gates exclusive and patents are pending.

Cueing is no problem with the Spot Tape Recorder, as it is done for you. Logging is simplified, and small tape packages or cartridges are not cluttering the control room. To play a spot, you simply move the indexing lever to any one of the 101 tracks, then push the Start button either direct or by remote control.

The Spot Tape index scale is graduated into major divisions of one through ten. Each division is further subdivided into letters "A" through "K". These scale divisions assure easy program logging and the control room engineer has a simple timetable to follow. As an example, we might have a program log reading: First National Bank #4H. The operator moves the pointer to 4H and the spot is ready to be played.

The automatic cueing and rewind facilities incorporated

**ST-101 SPOT TAPE RECORDER**

in Spot Tape go into action when the 90 second limit of tape travel is reached on any given track. At this 90 second interval, photoelectric cell control reverses the drive motor and rapid rewind takes place. Automatic rewind of the full tape is accomplished in 22 seconds. A 60 second announcement can be rewound in 15 seconds, a 30 second spot in 8 seconds by inserting the manual rewind switch. Manual rewind is possible at any time during the limit of tape travel. The manual rewind switch is located on the front panel and on the remote control unit. At the limit of tape reversal, a second photoelectric cell control reverses the drive motor and stops the tape movement. The same precise starting point is available for each of the 101 separate announcements.

The Gates Spot Tape Recorder is designed to be mounted in a standard relay rack, or in a cabinet for table mounting. The cabinet mounting size is 10" x 20" x 20" and weighs 60 pounds. The rack mounted unit requires 8<sup>3</sup>/<sub>4</sub>" of rack space, depth is 16<sup>1</sup>/<sub>2</sub>", and weighs 47 pounds. A rack mounting shelf is supplied with each unit. The unit then slides in and out of the cabinet or rack similar to a filing cabinet drawer.

Spot Tape Recorder is ready to operate when received. The unit may be connected to the station console in any convenient manner. The output level is approximately -20 dbm — the input level is for either microphone or bridging.

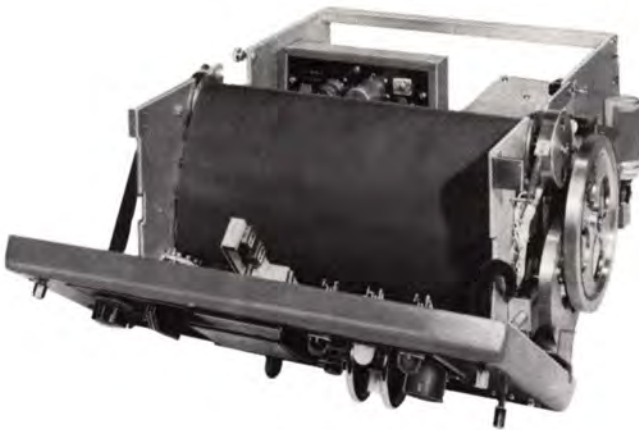

Front panel open and top off showing tape and amplifier. Top panel removes and front hinges down easily for complete accessibility to major components.



Recorder can be pulled partially out of cabinet for quick spot checking and maintenance.



Through transparent slits in tape, special lamps and photocell arrangement control stop, cue and rewind of tape.

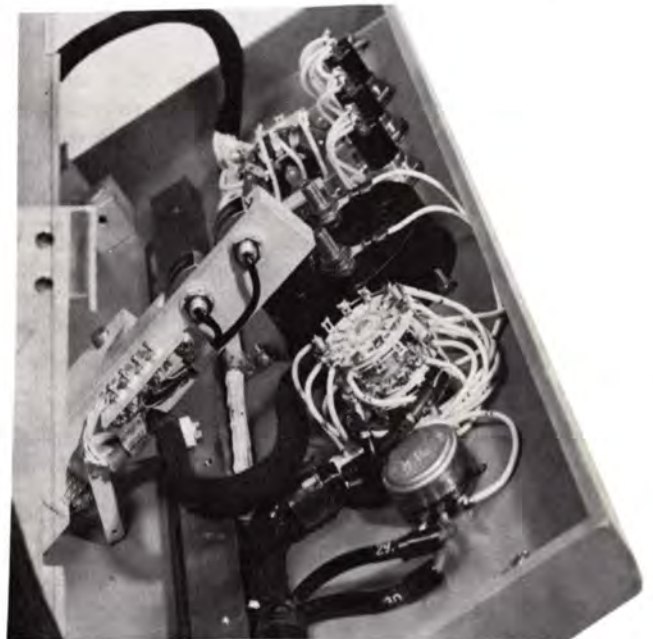

Back view of front panel showing how main components can be reached quickly and easily.

## ST-101 SPOT TAPE RECORDER

## GENERAL OPERATION

Actual operation is nearly identical to any professional tape recorder. For recording or playback, the few simple controls on Spot Tape are properly set, the index lever moved to the spot to be either recorded or played back and the rest is quite the same as broadcasters are well familiar with. Indicator lights for all functions assure the operator he is correct.

As the input is for either a microphone or bridging across a 500/600 line, recording through the station's audio system or by direct microphone input permits dubbing, filter effects, themes, etc., to be recorded on Spot Tape. For straight voice announcements, the microphone may be connected direct or through the station's audio system, as desired.

Spot Tape may be used in near proximity to an AM transmitter with only nominal precautions. During the year of research, 5KW FM transmitters were frequently tested within a short distance of Spot Tape.

**MODE OF OPERATION:** Broadcasting stations will find many applications that could not be mentioned herein because of lack of space. Spot Tape is not automation but a method of producing the best your staff has to offer through planned, well-thought-out announcements. Once recorded, the station is then always offering the best, regardless of the time of day or the changing moods that affect announcers just the same as executives.

Spot Tape eliminates the long continuous tape with the complex cueing problem and replaces it with 101 tapes all side by side and on one tape 13" wide. The result is immediate identification of the spot announcement. Many stations reserve a group of spots for so-called standards. One station gave the weather each day at noon. As it was July, he decided the temperature would be between 80 and 90 and reserved all of group 8 on the index for this spot, with the temperature following, or 8E was a temperature of 85. — In short, with Spot Tape, the possibilities are almost limitless.

**OTHER USES:** For paging, air lines in calling flights, bus and rail terminals, and many other similar services, Spot Tape offers a new and improved progressive system.

## OPERATING CONTROLS

**RECORD VOLUME CONTROL:** Controls the recording level and has no function in the playback mode.

**FUNCTION SWITCH:** When the switch is in "Play" position, it is only necessary to select the spot to be played

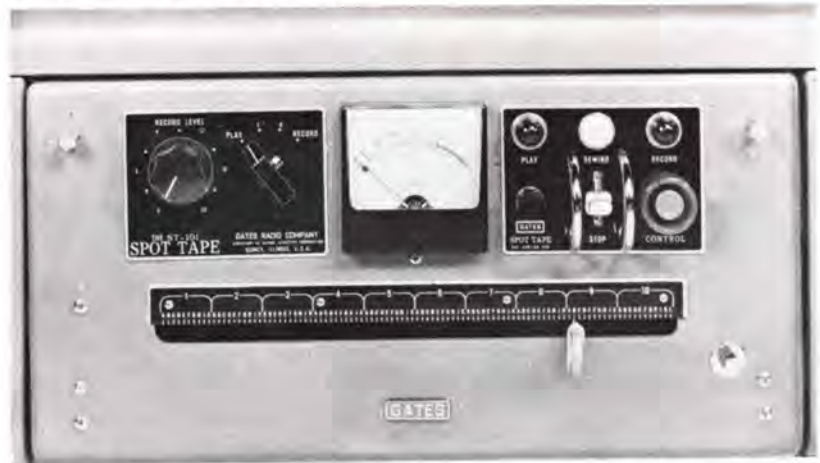

and push the START button. Position 2 of the function switch is for measuring erase current, as indicated on the VU meter, and Position 3 is for measuring bias current. Position 4 (record) places Spot Tape in condition for recording and also operating the erase head which precedes the recording head.

**PLAY START SWITCH:** The "Play" pushbutton starts Spot Tape for playback only and the associated pilot light above this switch indicates this function.

**RECORD "START" PUSHBUTTON** starts the tape for recording only. This switch interlocks with the record position on the function switch to the left of the meter. A guard is also provided to prevent accidental operation of the record pushbutton.

The remote control unit duplicates all functions of the operations panel.

**"STOP-REWIND" KEY SWITCH:** when to "Rewind", the tape is reversed and brought to original starting position. This function permits quick recycling in case of a very short spot where the operator cannot wait for full run out of the tape. It is also used for editing. The bottom position "Stop" will stop forward motion at any point on the tape. When in the center position (normal), the tape is running forward.

**VU METER:** Reads recording level as the main function but also indicates bias and erase current (see function switch above). The VU meter does not indicate in the playback cycle.

**MUTING:** During the rewind and cue up cycles, the output of the playback amplifier is automatically muted through self-contained relays.

**REMOTE CONTROL:** This extra unit duplicates all start, stop, rewind and record switching functions on Spot Tape. Though the basic design requires Spot Tape to be near the operating control point, the remote control unit permits placing Spot Tape on a roll-away table or at a more convenient location in the control room.

**ST-101 SPOT TAPE RECORDER**

**SPECIFICATIONS**

**TIME CAPACITY:** 101 separate tracks, each 90 seconds or less. Double or triple spotting on one track adds to the practical capacity.

**TAPE SPEED:** 5 1/4 inch/second.

**RESPONSE:** 50-8000 cycles ±2 db.

**NOISE:** 45 db. or better below -20 dbm output.

**DISTORTION:** 2% or better at normal recording level.

**WOW OR FLUTTER:** 0.35% or lower.

**WIDTH OF TAPE:** 13.000 ±0.002".

**BIAS FREQUENCY:** 60 Kc.

**INPUT IMPEDANCE:** 30/50-150/250 ohms at -60 dbm. (microphone) 10,000 ohms at -35 dbm. (bridging 500/600 ohms).

**CUEING CAPACITY:** ±0.25 inch or ±0.05 second.

**OUTPUT LEVEL:** -20 dbm.

**OUTPUT IMPEDANCE:** 150/250-500/600 ohms.

**TUBES:** (3) EF-86, (2) 12AX7, (1) 12AU7. All rectifiers are dry type silicon.

**POWER:** 115 volts, 60 cycles, 100 watts.

**DIMENSIONS:** (rack model) 19" wide, 8 3/4" high, 16 1/2" deep.  
(cabinet model) 20" wide, 10" high, 20" deep.

**WEIGHT:** (rack model) 47 lbs.  
(cabinet model) 60 lbs.

**CUBAGE:** 6 (packed).

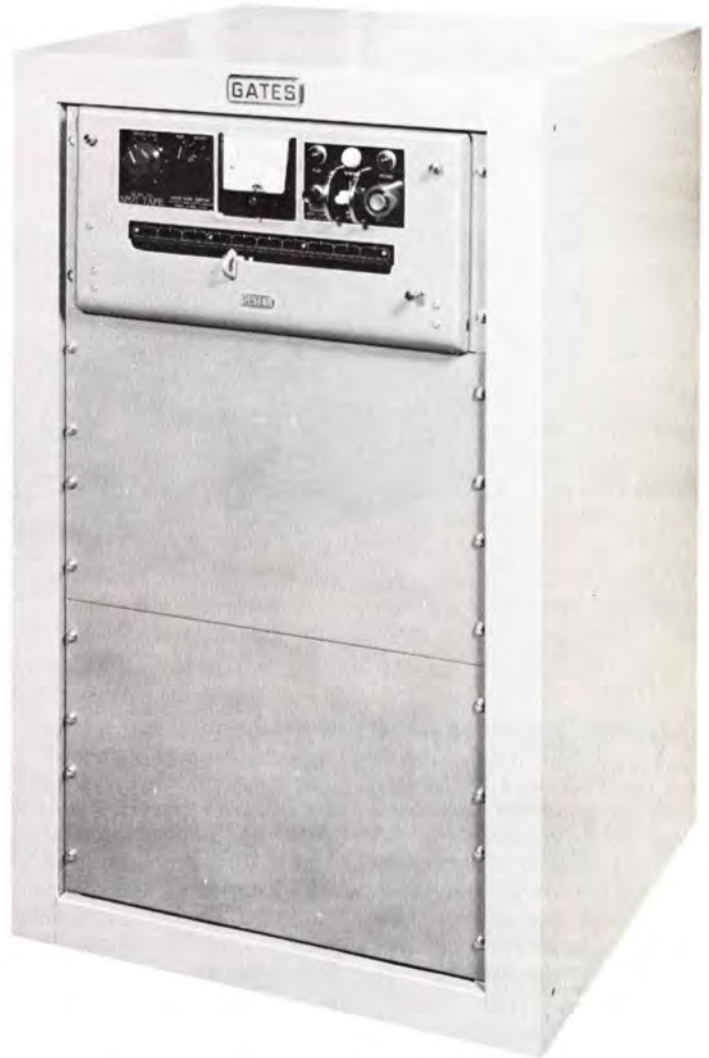

GATES SPOT TAPE RECORDER has been designed for both desk and rack mounting.



SPOT TAPE REMOTE CONTROL UNIT

**ORDERING INFORMATION**

Gates ST-101 Spot Tape with tubes and one roll of tape installed .....	M-5735
100% spare tube complement .....	TK-351
Extra tape roll .....	M-5840

**COMMENT:** Exhaustive tests operated Spot Tape for 18,000 continuous cycles without turn off and leaving tape playback head on same track with no adverse effects on tape life or quality. Tapes may be replaced in about 15 minutes time if need be, but routine exchange of tapes is not needed or recommended. Mylar tape is used exclusively for long life and reliability.



# Carritape



The newest member of Gates' complete programming family is CARTRITAPE. CARTRITAPE is the tape transport and playback unit of an entirely new system, designed to give the advanced broadcaster the ultimate benefit from magnetic tape cartridges. CARTRITAPE quality is equal to first rate reel-to-reel machines. Its automatic cueing and starting feature is second to none. Recording and playback are accomplished with simplicity, and functional operation is positive and fast.

While CARTRITAPE will perform nearly any programming duty, it is especially suited for reproduction of announcements, production aids, themes and the "top fifty" of the week. It is an excellent partner for the famous Spot Tape, where even greater facilities are desired.

Several CARTRITAPE units may be cross-connected to give completely automatic programming segments. This is the answer for those who desire interspersed automatic and live or manual programming from the same equipment. One switch will convert a CARTRITAPE system from manual to automatic (and vice versa) operation in a split second. Material may be interchanged rapidly to build up a variety of automatic programs without the necessity of recording the entire show each time.

## OPERATION AND FEATURES

Any number of commercials, themes, etc. may be sequentially recorded on a single cartridge until the tape is completely filled. Segments can be as small as a second or as long as 46 minutes. Three basic cartridge sizes are available to handle the desired playing time.

The system includes, in addition to CARTRITAPE, the Recording Amplifier, the four channel Switcher, the Remote Panel and many other accessory items. The Recording Amplifier plugs into any CARTRITAPE unit and relay operation permits recording or playback without reconnection each time. The Cue Control tone is recorded on one half of the tape for a brief time just before the program is recorded on the other half. This control tone burst stops the tape at precisely the right time, before the announcement, to give optimum split-second cueing with no trace of wow. If it is attempted to record past the cue tone (more time than is available on the cartridge) the machine will stop, even in the recording cycle — showing the necessity of a larger tape or shorter program. Thus, programming errors are automatically rejected without aural review.

Two solenoids and sequential switching are used to give optimum performance in CARTRITAPE. When the cartridge is inserted a switch is triggered to: energize the "ready" solenoid — which swings the pinch roller through 99° of its 102° arc, start the motor and light the "ready" light. When the local, remote or automatic "start" switch is pushed: The second solenoid swings the pinch roller through the last 3° of its arc, the "run" light is energized and the tape is instantly running at full speed.

This operation allows the unit to be stopped and started between syllables without noticeable wow. It also allows consistently tighter cueing on the start of any programming segment than can be obtained with any other type of broadcasting equipment.

# Carritape



## FEATURES

1. Programming — from one syllable to 46 minutes, instantly available.
2. Quality — similar to any good grade professional tape equipment.
3. Operation — extremely simple in either recording or playback.
4. Dependability — simple, direct and trouble-free with only minimum maintenance.
5. Quick Change — throw one switch to instantly convert from manual to automatic operation.
6. Cueing — accurate and negligible dead air time.
7. Versatility — infinite numbers of programs may be built around the same recorded cartridges.
8. Complete System — designed to give the broadcaster all the desired facilities for modern broadcasting.
9. Motor — runs only when cartridge is inserted, saving useless wear and heat.
10. Program Material — completely enclosed in plastic or metal cartridges, as desired.
11. Protected — no spilling or breaking of tape due to handling or storage.
12. Instant use — no threading or manual or aural cueing required.
13. No Rewind — at the end of the tape the cartridges are cued up and ready to play again, immediately or after storage.
14. No Speed Change Errors — single 7½" IPS, tape speed, no errors due to running cartridges at the wrong speed.
15. Remote Operation — without modification. Connect remote switching to proper plug terminals.
16. Illuminated Push Button — operation to show that power is on and the exact function status.

17. No Limit — to the number of announcements or programming segments available for each and every machine.
18. Equalization — standard NAB recording and playback equalization.
19. No Accidental Erasures — no erase heads in the CARTRITAPE system, bulk erasing easily accomplished in seconds. Bulk eraser optional.
20. Cartridges Available — unloaded or loaded from 1 second up to 46 minutes with the standard lubricated tape.
21. Switcher — to electrically feed a CARTRITAPE into a single console circuit for limited automatic programming and conservation of console facilities.
22. Any Number of Switchers — may be connected in series to give an unlimited number of tape inputs into one console channel.
23. 19" or 15" Panels Available — in CARTRITAPE, Recording Amplifier or Switcher for standard rack or custom cabinet mounting.
24. Desk Mount Without Cabinet — CARTRITAPE enclosure designed for attractive desk top mounting without cabinet (15" panel).
25. Entirely Self-Contained — all units have self-contained power supplies.
26. Quick Disconnect Plugs — used throughout system. Interconnecting cables and motor and "run" solenoid on quick disconnect plugs.
27. Access Doors — with ¼ turn fasteners for lubrication and inspection of motor and linkage without dismantling enclosure.
28. Compatible Styling — to enhance the appearance of a distinctive broadcasting system.



The Gates Carritape offers complete accessibility for maintenance. Each side slips off with quick fastener screws.

**GATES**

# Carritape

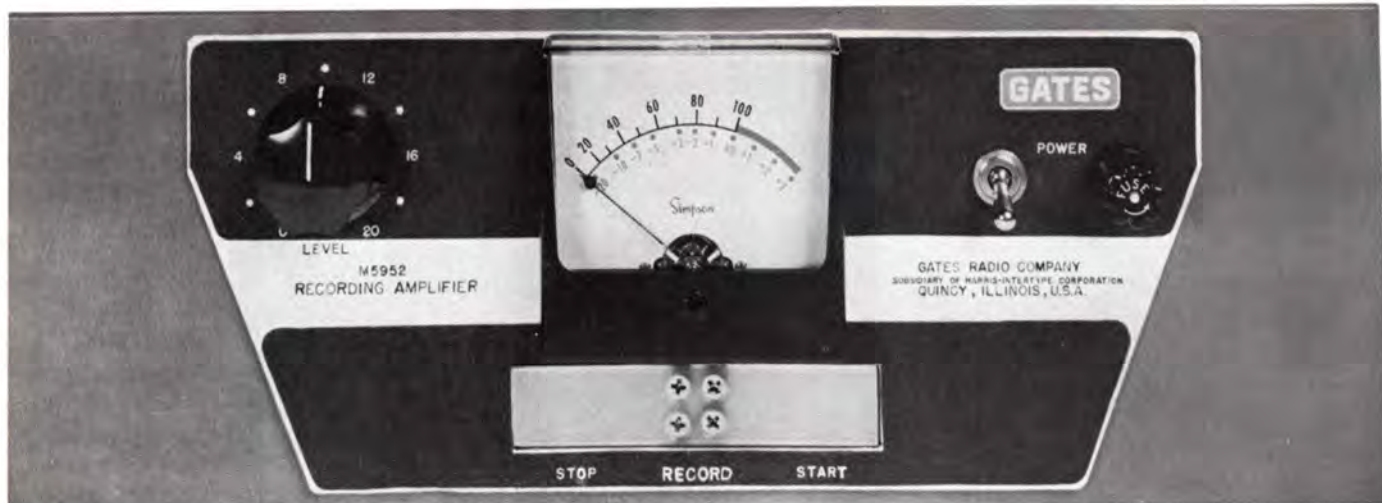

Shown above is the recording amplifier, which plugs into any CARTRITAPE unit. Relay operation permits recording or playback without reconnection each time.

## SPECIFICATIONS

### M5944 CARTRITAPE Playback Unit

**FREQUENCY RESPONSE:** Standard N A B playback curve,  $\pm 2$  db, 50 to 12,000 CPS., @ 7.5 IPS.

**DISTORTION:** 2% or less @ normal recording level.

**NOISE:** 60 db or lower, below tape saturation level, 50 db or lower, below normal recording level.

**WOW AND FLUTTER:** 0.1% to 0.2% RMS.

**TAPE SPEED:** 7½" per second.

**EQUALIZATION:** Standard NAB playback equalization for 7.5 IPS.

**PLAYING TIME:** 1 second to 46 minutes in three basic cartridge sizes.

**OUTPUT LEVEL:** -20 dbm @ 500/600 ohms (factory connected), may be strapped for 150/250 ohm output.

**CUEING ACCURACY:** Within 0.1 second. (as recorded).

**START TIME:** 0.1 second or less.

**STOP TIME:** Essentially instantaneous.

**POWER SOURCE:** 115 volts, 60 CPS. (50 cycle model available on special order at slightly higher price.)

**POWER CONSUMPTION:** 35 watts in the "ready" position.  
125 watts in the "Run" position.

**TUBE COMPLEMENT:** (2) 12AX7, (1) EF86, (1) 2D21 and (1) 6X4.

### MECHANICAL

**HEIGHT:** 7 inch Rack or custom Cabinet mounting.

**WIDTH:** 19 inch Rack or 15 inch custom Cabinet mounting.

**DEPTH:** 13 inches behind panel, excluding plugs.  
14¾ inches overall.

**THREE STANDARD MOUNTINGS:**  
Standard 19 inch Rack,  
Custom 15 inch Cabinet,  
Desk top, with or without cabinet.

**WEIGHT:** Net 26 lbs., packed (domestic) 49 lbs., cube 5.

**AUXILIARY:** Remote Start  
Remote Stop  
Remote Record Start  
Remote Record Stop  
Remote Cue Interlock  
Remote Record Interlock  
Synchronized Start Circuit  
Synchronized Cue Controlled Stop Circuit  
Synchronized Automatic Sequential Start Circuit.

### M5952 RECORDING AMPLIFIER

**FREQUENCY RESPONSE:** Standard N A B recording curve,  $\pm 2$  db, 50 to 12,000 CPS. @ 7.5 IPS.

**DISTORTION:** 0.5% or less @ normal recording level.

# Carritape



POWER: 115 volts, 50/60 CPS., 7 watts.  
RELAYS: Telephone type (type "J" or equivalent).

**MECHANICAL**

HEIGHT: 3 1/2 inch Rack or custom Cabinet mounting.  
WIDTH: 19 inch Rack or 15 inch custom Cabinet mounting.  
DEPTH: 3 1/2 inches behind panel, excluding plugs.  
5 1/4 inches overall.  
PANEL: Hinged and secured with 1/4 turn fastener to permit quick access to dust protected relay contacts.  
WEIGHT: Net 6 lbs., packed (domestic) 10 lbs., cubage 1.

NOISE: -120 dbm or lower, relative input noise with microphone level into matching input circuit.  
EQUALIZATION: Standard NAB recording curve for 7 1/2 inches per second.  
INPUT LEVEL: -50 to -70 dbm at 30/50 or 150/250 ohms.  
-35 to +8 dbm at 10,000 ohms bridging. (both balanced or unbalanced)  
CUEING ACCURACY: Within 0.1 second, (as recorded)  
POWER SOURCE: 115 volts, 50/60 cycles per second.  
POWER CONSUMPTION: 25 watts.  
TUBE COMPLEMENT: (2) EF86, (1) 12AX7, (1) 12AU7 and (1) 6X4.

**MECHANICAL**

HEIGHT: 7 inch Rack or custom Cabinet mounting.  
WIDTH: 19 inch Rack or 15 inch custom mounting.  
DEPTH: 11 inches behind panel, excluding plugs.  
12 3/4 inches overall.  
WEIGHT: Net 12 lbs., packed (domestic) 27 lbs., cubage 3.

**M-5953 SWITCHER**

INPUT CHANNELS: Four, 500/600 ohms (factory connected). 150/250 ohms also possible by changing load resistor.  
CROSSTALK: More than 65 db below normal recording level.  
SWITCHING TIME: 0.02 seconds or less.

**M-5960 REMOTE PANEL**

SWITCH CONTROLS: 4 CARTRITAPE Playback units or 3 CARTRITAPE playback units and 1 recording unit. Panel contains 4 "Start" push-buttons and "Record" and "Off" push-buttons.  
HEIGHT: 3 3/4". The M5965 mounting box is 3 7/8".  
WIDTH: 6". The M5965 mounting box is 6 1/4".  
DEPTH: 2 3/4". The M5965 mounting box is 3 1/4".  
MOUNTING CENTERS: 2 3/4" by 5 1/4".  
CONNECTIONS: Quick Disconnect Plug.

**ORDERING INFORMATION**

CARTRITAPE, 19" Panel .....	M-5944
CARTRITAPE, 15" Panel .....	M-5944A
Recording Panel, 19" .....	M-5952
Recording Panel, 15" .....	M-5952A
Switcher, 19" Panel .....	M-5953
Switcher, 15" Panel .....	M-5953A
Remote Panel .....	M-5960
Mounting Box for above Panel .....	M-5965

NOTE: Suggested basic CARTRITAPE system would include (3) M-5944 (A) CARTRITAPE units, (1) M-5952 (A) Recording Panel, (1) M-5953 (A) Switcher, (1) M-5960 Remote Panel, and (1) M-5965 box for remote panel.

# AUTOMATIC TAPE CARTRIDGES

The Fidelipac automatic Tape cartridges featured here are continuous, self-contained, single reel tape cartridges which operate on an endless loop principle. The tape is pulled from the center and after passing the playing or recording head is automatically rewound on the outside of the reel contained in the cartridge. This process goes on continuously until the machine is stopped or the cartridge is removed. Individual or multiple messages or musical selections, of varying length, will be repeated, limited only by the length of tape in the magazine. The tape is completely contained in the plastic magazine and is never touched by the operator. The cartridge is merely inserted in the Cartritape and is in operation.

## ADVANTAGES

- No Threading — thus eliminates difficulty of threading tape on take-up reel; also prevents twists and kinks.
- No Rewinding — preventing excess slack and spillage — eliminates complicated handling.
- Eliminates tape breakage due to tension differences in supply and take-up reels; eliminates nicks, cut and creases that cause tape breakage.
- Simplifies storage of cartridges which are designed to stack one on top of another in a self-storing unit.
- Minimizes damage from dust and grit thereby extending tape life.
- Ease of handling.
- The applications are virtually unlimited.

## STANDARD MAGAZINES

- MODEL 300 SIZE:  $5\frac{1}{8}'' \times 4'' \times \frac{7}{8}''$  contains 300 feet of single coated Mylar\* tape.
- MODEL 600 SIZE:  $7'' \times 6'' \times \frac{7}{8}''$  contains 600 feet of single coated Mylar\* tape.
- MODEL 1200 SIZE:  $8\frac{3}{4}'' \times 7\frac{1}{2}'' \times \frac{7}{8}''$  contains 1200 feet of single coated Mylar\* tape.
- LIFE EXPECTANCY: The Fidelipac Tape Cartridges have been completely laboratory and field tested and a life of upwards of 3000 hours of operation may be expected.

\*DuPont Trademark

## ORDERING INFORMATION

TIME	300 Series	MODEL
Empty .....		F-300
40 Seconds .....		F-300A
70 Seconds .....		F-300B
100 Seconds .....		F-300C
3½ Minutes .....		F-300D
5½ Minutes .....		F-300E
11 Minutes .....		F-300G

TIME	600 Series	MODEL
Empty .....		F-600
16 Minutes .....		F-600H
1200 Series		
Empty .....		F-1200
31 Minutes .....		F-1200J
45 Minutes .....		F-1200K
VIKING CARTRIDGES		
Empty .....		V-300
Empty .....		V-1200

(Transparent cover on Fidelipac cartridges shown for illustration only. Models 600 and 1200 supplied with the new blue opaque covers only.)

MODEL 1200



MODEL 600



MODEL 300



VIKING

# "AUTO-TRANS" AUTOMATIC PROGRAMMING EQUIPMENT



"Auto-Trans" is the automatic transcription turntable equipment for 45 RPM records that requires only the pushing of a button to start the next record. Capacity is up to 100 double-faced records, or nearly 10 hours.

"Auto-Trans" consists of a 100-record capacity (200 selection) automatic changer modified with an ingenious relay system to omit dead air time. When played in sequence, time spacing is less than 10 seconds between records or just enough time for the shortest announcement. — Where records are selected at random, the time between discs is slightly greater. In all instances, time between discs is being consumed by announcements and the next record does not start until the announcer presses the button.

Standard equipment includes the record changer mounted in steel case, relay control system for start-stop and automatic cueing, individual record selector switch for either side of the record and remote control operating switch box. A 4-stage equalized preamplifier is inbuilt. Equalization is to standard NAB 45 RPM RIAA curve, old NAB and a filter position. Output impedance is 150/600 ohms. Diamond stylus is provided. No accessories are required other than the usual studio equipment.

## SPECIFICATIONS

- SIZE: 38½" wide, 17½" deep, 16¼" high (front door closed).
- FINISH: Medium gloss gray.
- OUTPUT LEVEL: —20 dbm.
- OUTPUT IMPEDANCE: 150/600 ohms.
- POWER: 115 volts, 60 cycles.
- RESPONSE: Standard NAB curve for 45 RPM.
- NOISE: 55 db or better below —20 dbm (preamplifier)\*.
- DISTORTION: .5% or less 50-15,000 cycles at —20 dbm output.

## ORDERING INFORMATION

"Auto-Trans" complete with remote control station and ready to use ..... M-5452



\* Stylus or record condition will always affect performance and specifications are electrical conditions only.

# "NITE-WATCH" AUTOMATIC PROGRAMMING SYSTEM



ABOVE: Tape and Control Cabinet

RIGHT: Production Unit

BELOW: 100 record automatic cueing transcription equipment.



## 3 in 1 System

Here is the 3 in 1 system — automatic programming — professional tape recording and — automatic transcription equipment. Here is a system that may be used all day long for the major service needs of professional quality tape recording and the complete handling of 45 RPM transcription needs plus — the progressiveness of automatic programming.

Operation of "Nite-watch" is by no means complicated. Actually, it is more simple than a control board operation. Continual programming up to as much as six hours is easily possible. The amount

of automatic programming is at the discretion of the program director.

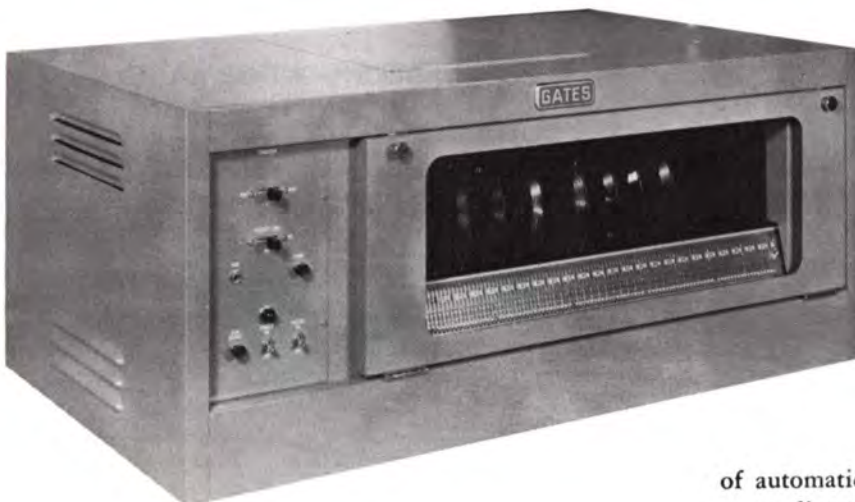

## "NITE-WATCH" AUTOMATIC PROGRAMMING SYSTEM



Illustration of "Nite-watch" where tape transport and control amplifier are mounted in broadcaster's rack cabinet. Arrows indicate equipment supplied as standard and balance is for illustrative purposes.

Taking a 2-hour program quickly illustrates operating procedure. Announcements are ready for the 2-hour show. The production unit has familiar controls, microphone mixer, turntable mixer for dubbing in jingles, etc., standard VU meter and headphone jacks. All announcements are made in sequence. After the first announcement, the announcer presses a button on the production unit that impresses an inaudible tone on the tape. He then continues with the second announcement, etc. In the playback procedure the tape is reversed to the starting point of the first announcement. After each announcement the tone stops the tape and starts the record, which automatically cues up during the announce period so negligible dead air will exist. Tapes may be instantly stopped, cued and reversed to correct announcing errors. Theme music or transcribed spots may be dubbed on the control tape with assured equal quality to that of the records.

In the above brief dry run we find that a 2-hour program may have ten 1-minute announcements, 22 average 20-second announcements and 34 average 3-minute discs, totaling 119 minutes, yet using 17 minutes of actual announcing time. Double this and 4 hours would use 34 minutes of announcing time, etc. In practice, the announce time could take a little longer as the an-

nouncer need not talk continually. He may stop to study his next script or cue up a jingle to be dubbed. Much more important than the time saved is the opportunity for topflight programming, multiple voices without increased time and the ability to recall "fluffs" before they reach the air.

The tape transport unit may be used for all modes of tape recording and playback when used with the production unit. Where it is desired to have the tape recorder entirely independent of the production unit, when used strictly as a tape recorder, the M5664 optional recording panel may be purchased.

In the 100 record changer, diamond styli and a special equalized preamplifier assure transmission characteristics to the correct broadcast audio curve. An ingenious relay system automatically cues to within 2 seconds of sound during the announce cycle. Minimum cue time from one record to the adjacent record requires a 10-second announcement. Segue is possible (no announcements between records) with about 8 seconds dead air between plays. — By purchasing the inexpensive optional M5665 remote control switcher, the changer may be operated identically to the "Auto-Trans."

It is recognized that some questions will occur to interested broadcasters that may not be fully answered on these pages. Any Gates sales engineer or the Gates — Quincy, Illinois Engineering Department will happily discuss these verbally or by response to your mail request.



M-5664 recorder panel is optional equipment where the purchaser desires a completely independent tape recorder/playback unit which may be used for highest standard tape recording at any time automatic programming is not in use. This unit is not mandatory as tape recording may always be done through the M-5661 production control unit.



Above illustrates the M-5664 recorder panel mounted below the tape transport and amplifier control panel.



## "NITE-WATCH" AUTOMATIC PROGRAMMING SYSTEM



By adding the optional M-5665 switch control box, the changer unit may be used as a complete remote operated "Auto-Trans."

### SPECIFICATIONS

#### Production Unit M-5661

**AUDIO INPUT:** Dual mixing channels. TT or line channel 150/600 ohms at -20 dbm. Microphone channel 50/150 ohms at -60 dbm.

**AMPLIFIER:** Cathode follower type for direct connection to tape recording amplifier.

**POWER SUPPLY:** Self-contained, fully regulated.

**HEADPHONE JACKS:** Two provided. One connects to output of production unit amplifier and for cueing the turntable. The other connects to the tape playback amplifier in the M-5662 control unit. This permits monitoring tape while recording, or checking and editing tape after announcement is recorded. (The tape machine has both a recording and playback head — the playback head feeds into the playback amplifier at all times.)

#### AUTOMATION

**CONTROL:** Dual push-buttons: (1) for announce, dubbing, etc., and (2) for changer operation. Accompanying each push button is an indicating light. A 20 cycle Weinbridge oscillator is engaged by pushing the changer button. The tape motion lamp shows when the tape machine is running and when it is stopped. During the editing process it indicates when the tape stops at the end of a recorded tone. Complete remote switching is provided for the tape machine to assist in editing. This includes start, stop, fast forward and rewind.

**SIZE:** 21" wide, 7 $\frac{1}{4}$ " high, 14" deep.

#### Tape/Control Unit M-5662

**TAPE TRANSPORT:** See Page 185 for full specifications.

**AMPLIFIERS:** Separate record and playback.

**OUTPUT IMPEDANCE:** 600 ohms balanced at -20 dbm to input of station speech input system.

**SWITCHING:** Input tape switch, record-playback switch, changer clear switch and associated indicating lamps.

**SIZE:** Cabinet model — 30" high, 21 $\frac{1}{4}$ " wide, 21 $\frac{1}{4}$ " deep. Rack mount units less cabinet — 19" wide, 21" high.

#### Automatic Changer/Cueing Unit M-5663

**CAPACITY:** 100, 45 RPM records.

**CUEING:** 2 seconds or less to sound track.

**SELECTING:** Tabs below each record slot permit indexing for playing on either side or bi-passing.

**CONTROLS:** Motor Off-On, Scan-Reject, Clear, Manual-Automatic, Power Off-On.

**RESPONSE:** RIAA, NAB and cut off curve.

**DISTORTION:** .5% or less 50-15,000 cycles (amplifier).  
**RUMBLE:** 35 db. or better below standard recording level.

**SIZE:** 39" wide, 16" high, 23" deep.

**POWER:** All units 115 volts, 60 cycles.

### ORDERING INFORMATION

- "Nite-watch" complete, includes production unit, cabinet model recorder/playback and changer unit, ready to operate ..... M-5671
- "Nite-watch" same as above but less cabinet for tape recorder and control amplifier (for your own rack cabinet) ..... M-5628
- Recorder panel for use with tape recorder where use of M-5661 production console is not desired for straight tape recording ..... M-5664
- Auto-Trans control switch box for using M-5663 changer as remote operated transcription equipment ..... M-5665

# "AUTO-STATION" AUTOMATIC PROGRAMMING SYSTEM



**Production Unit**



**Playback Unit**

Two distinctly separate units comprise the complete "Auto-Station." (1) The Production Unit, and (2) The Automatic Playback Unit. These units are not connected electrically in any way. They may be in the same room or miles apart. The Production Unit, as the word implies, is used in producing the programs. It is here that hours of programming are put together in only a fraction of the time required otherwise.

The Automatic Playback Unit is employed for the actual broadcasting or the program. The master tape created on the Production Unit is moved to the Playback Unit and handled entirely automatically.

"Auto-Station" utilizes the principle of the binaural tape transport mechanism. One-half of the tape carries the sound portion and to the other half is applied the various tones which trigger the automatic operation of the Playback Unit. This method permits almost limitless automation. Sub-audible tones, limited usually to only one tone, are not used. Instead, tones in the audible range may be used in generous numbers, if need be, to operate function after function. These tones cannot be aired as they are allocated to that half of the tape not devoted to sound.

Important is that the tape only operates during the announce cycle. When any other function is performing on the Playback Unit such as a record, delayed broadcast, etc., the main tape stops. This means that one tape will handle hour after hour of programming. More important, the announcements may be all made together. For example, a one-hour show might average 17 three-minute recordings, 6 one-minute announcements and 11 fifteen-second announcements, totaling 59+ minutes, yet with "Auto-Station" only 9 of these minutes would be used by the announcer as he makes all announcements at one time. "Auto-Station" separates the announcements between records automatically. Thus, it can be seen that 90 minutes of announcing would produce 10 hours of programming. Realistically, of course, an announcer will not talk continuously for 90 minutes but double this and you still have 3 hours production time for a 10-hour broadcast. For additional details, write the audio products section, Gates Radio Company, Quincy, Illinois.

## ORDERING INFORMATION

Complete "Auto-Station" including Production and Playback Units and one 4800 ft. roll of tape ..... M-5429

## SA-39B PEAK LIMITING AMPLIFIER

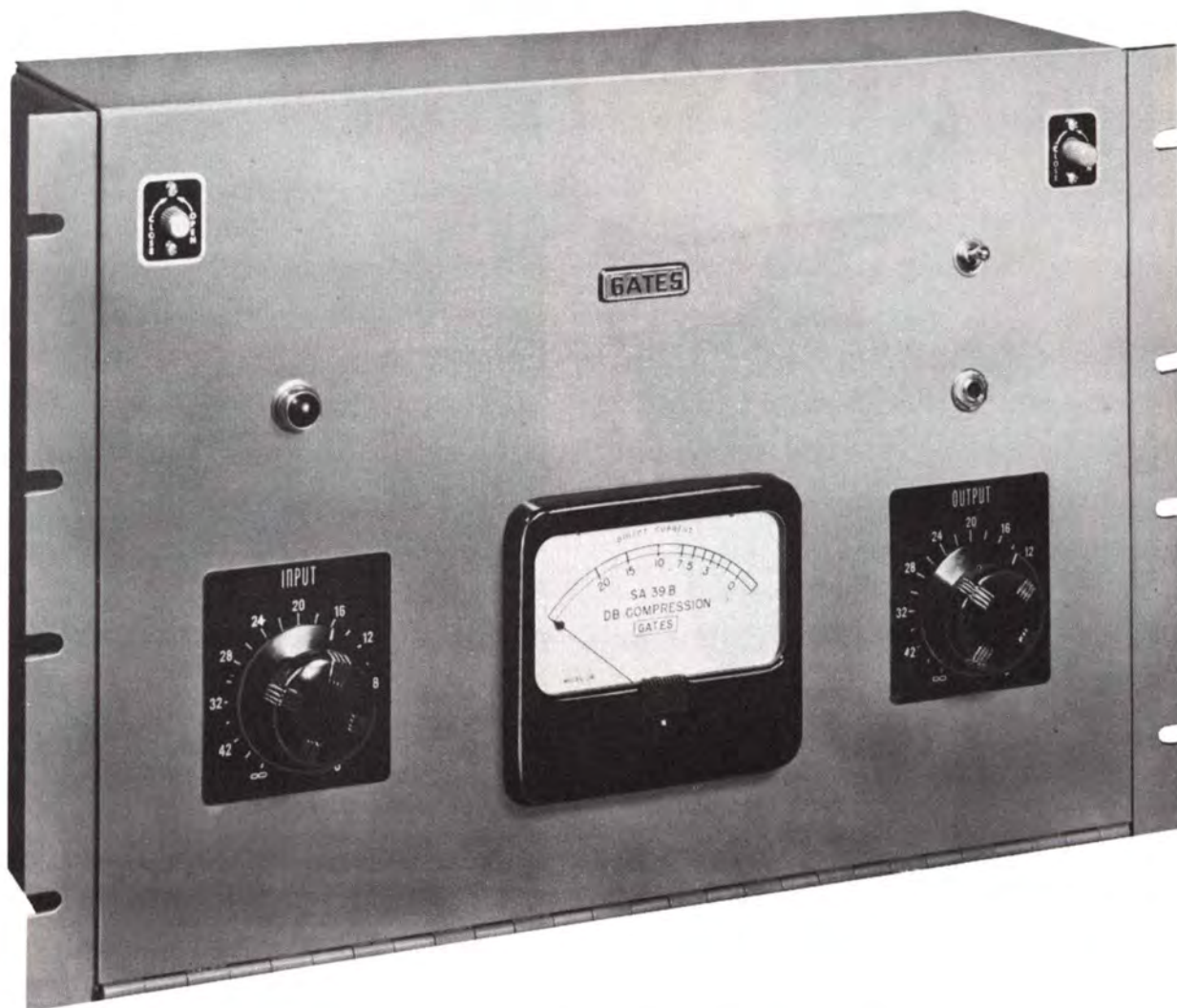

Combining fine performance standards with design emphasis on easy serviceability, the Gates SA-39B limiting amplifier is a worthy successor to the hundreds of early Gates limiters which have earned an enviable reputation for fineness.

This unusual limiter circuit was originally designed in cooperation with British Broadcasting Company engineers. Elaborations on the design have been made as the art progressed. Today's model is often considered the standard of comparison both as to smooth, fast limiting performance and very low distortion at abnormally high degrees of limiting action.

Very fast attack time, essentially instantaneous, is associated with six switch-selectable release times. In this manner the engineer may adopt the mode of operation best suited for him. Limiting action is by full wave rectification of the output voltage with the resultant negative direct current fed to the second control grid of the pushpull input stage. As the output voltage increases, the grid becomes more negative, lowering the gain of the amplifier. — Along with fast action, no added distortion is induced at compression levels as high as 20 db.

**SA-39B LIMITING AMPLIFIER**

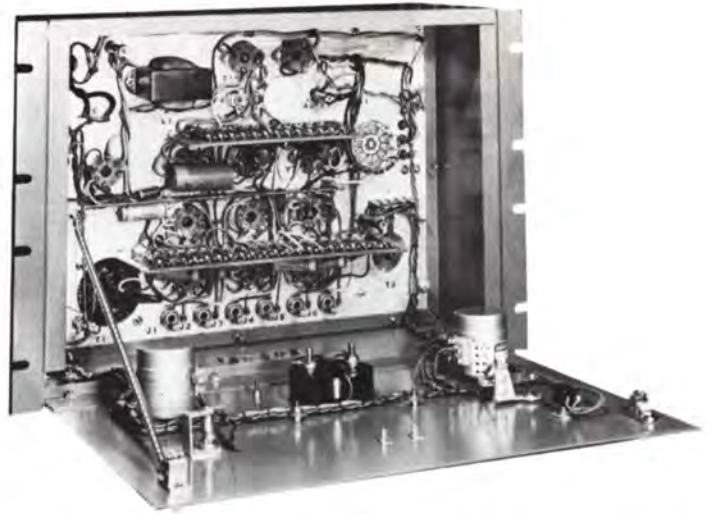

Circuit design provides three push-pull stages having both input and output level control. An electronically regulated power supply incorporates 6X5, 6SJ7 and 6L6G tubes with the 5V4G cathode type rectifier. This guarantees limiter calibration over wide ranges of line voltage. — A wide scale 4" meter is calibrated in decibels of compression for direct reading.

In the several illustrations herein, the ease of servicing and maintenance will be observed. Front panel hinges down to expose all under-chassis parts. Easy cleaning of the under-chassis with a bellows or small suction type cleaner assures trouble-free operation.

**SPECIFICATIONS**

- IMPEDANCES: 500/600 ohms input and output.
- INPUT LEVEL: -20 to +20 db (adjustable by attenuator).
- OUTPUT LEVEL: +25 dbm or less (adjustable by attenuator).
- MAXIMUM GAIN: 55 db.
- AUDIO RESPONSE: 30-15,000 cycles  $\pm 1\frac{1}{2}$  db.
- AUDIO DISTORTION:  $1\frac{1}{2}\%$  or less 30-15,000 cycles at 20 db compression.
- NOISE: 70 db or better below any adjustable output level.
- ATTACK TIME: Essentially instant.
- RELEASE TIME: Six positions from 0.2 to 1.2 seconds.
- SIZE: 19" wide, 14" high, 9 $\frac{1}{2}$ " deep.
- FINISH: Medium gloss gray.
- DC REGULATION:  $\pm 5$  volts of main plate supply.
- POWER INPUT: 115 volts, 50/60 cycles, 90 watts.
- TUBES: (2) 1612, (2) 6V6GT, (3) 6SJ7, and one each 6H6, 6S5GT, 6Y6G and 5V4G.
- WEIGHTS: Net 36 lbs. Domestic packed 74 lbs. Export packed 96 lbs. Cubage 9 $\frac{1}{2}$ ".

**ORDERING INFORMATION**

- Model SA-39B Limiter with tubes ..... M-3529B
- Spare 100% tube set for above ..... TK-150

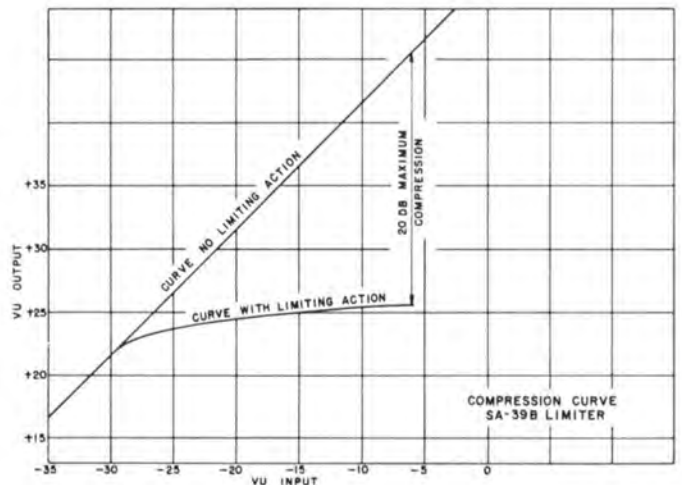
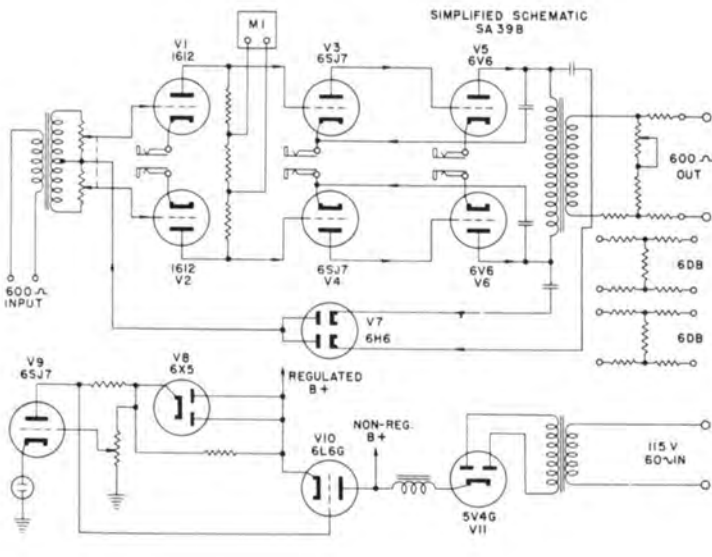

# "STA-LEVEL" AUTOMATIC PROGRAM LEVEL AMPLIFIER



Perhaps no single equipment in all of broadcasting has done so much for so little cost as the Gates "Sta-Level." The basic function is to provide constant level output. "Sta-Level" brings up the low passages as well as holding down excessive output level. The result is always higher level of transmission, the equivalent of greater signal output.

"Sta-Level" automatically adjusts for different input levels, or it differs from a peak limiting amplifier by raising level, if it is too low, and reducing level if too high. Practical and very realistic results become obvious. A few are:

(1) Psychologically, to prevent excess level, the operator will very naturally maintain lower levels. This makes the softer passages very low indeed. When "Sta-Level" is in the circuit, two important things happen: (a) output levels may be higher as they are automatically protected, and (b) the low, soft passages are automatically raised in level.

(2) The effect of (1) above is identical to turning up the volume control of all the receiving sets, or — raising power. If you increase your average program level 3 db, you have the same effect as doubling transmitter power. The nice part is that "Sta-Level" in many instances has gone far beyond the minimum of 3 db increase.

(3) "Sta-Level" will automatically adjust for different levels. We all are acquainted with the varied output levels of records and transcriptions. Furthermore, in these busy music-news days of broadcasting, the operator cannot keep his eyes glued to the VU meter. "Sta-Level" automatically brings up the low turntable and holds down the high one without operator attention.

(4) Here is a use many are finding for "Sta-Level": In disc jockey shows, by setting the microphone level higher

than music level an automatic fade of music during the voice transmission is possible and excellently done. For example, if the microphone fader on the speech equipment is set 15 db above the turntable fader, when using the microphone, the music will fade 15 db. Music will return to normal level when microphone is no longer used. Recovery time is smooth, quite like a normal up fade.

## GENERAL INFORMATION

**RECOVERY SPEED:** As supplied, "Sta-Level" recovers 2/3 level in 7 seconds and 90% level in about 28 seconds. This is considered typical. However, a kit of small fixed resistors is supplied. If the operator feels this is too slow or too fast, he may, by changing two resistors, increase recovery to as fast as 2 1/4 seconds for 2/3 level and 10 seconds for 90% level, or as slow as 11 1/4 second for 2/3 level and 45 seconds for 90% level.

**ACCESSORIES:** None needed. "Sta-Level" is a complete one-chassis unit, regulated power supply and all self-contained.

**GAIN:** As "Sta-Level" has up to 62 db gain, if your present system is short of gain, "Sta-Level" will pick it up. Of course, both input and output level controls are on the front panel to adjust for any gain you wish right down to unity or up to the full 62 db.

# "STA-LEVEL" AUTOMATIC PROGRAM LEVEL AMPLIFIER

## SPECIFICATIONS

**POWER SUPPLY:** Regulated type, self-contained.

**POWER INPUT:** 105/115 volts, 50/60 cycles at 50 watts.

**RECOVERY:** Switch selects average or dual recovery time to accommodate operational mode best suited to engineering preference.  
Chart provided as guide.

**COMPRESSION:** Special regulator circuit holds threshold of compression constant. Rated 0-30 db but excellent performance to 40 db.

**DISTORTION:** 1% or less 50-15,000 cycles 0-30 db of compression when using +20 dbm output threshold level.

**RESPONSE:**  $\pm 1$  db 30-15,000 cycles, 0-30 db compression.

**NOISE:** 65 db below output 0-30 db compression at +20 dbm threshold level.

**GAIN:** 62 db  $\pm 2$  db.

**IMPEDANCES:** 600 ohms input and output.

**SIZE AND CONSTRUCTION:** 19" x 5 1/4" panel. 7" deep. Front panel drops down to service all internal parts.

**TUBES:** Two 6V6, one each 6386, 12AT7, 6AL5, OB2, 5Y3GT.

**FINISH:** Medium gloss gray with lettering in white.

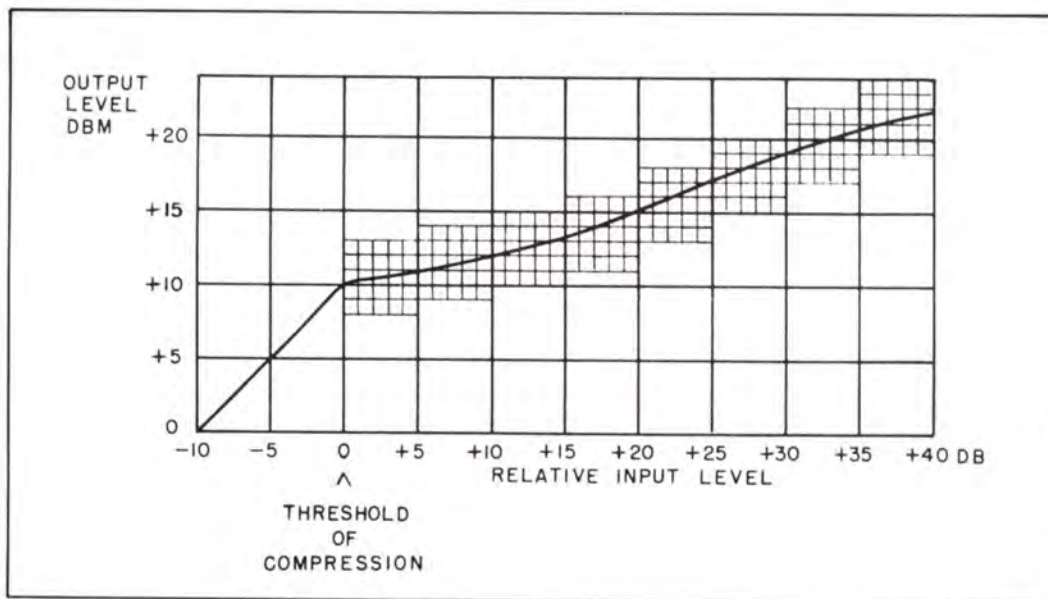

## ORDERING INFORMATION

"Sta-Level" complete with tubes and ready to operate ..... M-5167  
Spare 100% tube kit for above ..... TK-243

Front panel drops down for complete inner servicing. Big advantage of this type of construction is ability to keep important inner workings clean by means of bellows or small suction type cleaner.



## "LEVEL DEVIL" PROGRAM GATED AMPLIFIER



*A new average level amplifier where in the absence of signal, the aural noise level does not rise above the original level established by the average signal.*

A contrast will best illustrate the marked engineering advancement in the new Gates "Level Devil". In older average level amplifiers, during a period of program silence, the lower signal level referred to as noise was expanded. A baseball or football game is an excellent example. When the sports announcer was silent for a moment or two, the crowd noise expanded to a sizable increase. Conversely, when the announcer spoke, the crowd noise immediately decreased.

With "Level Devil" this difficulty is overcome. In the absence of signal, the noise level does not rise above the original level established by the average signal. With older average level amplifiers, the noise will rise 10 to 15 db. under equivalent conditions. — The engineer will quickly recognize the ability to further up level his programming as the concern of noise expansion is now at a minimum.

Constant level amplifiers have, until "Level Devil", had

limitations in TV use. A film with a signal to noise ratio of 30 db. (average value) could not tolerate a background noise increased during a period of silence on the film. With older constant level amplifiers, the background noise would increase around 10 db. — very noticeable to the listener. "Level Devil" overcomes this background noise increase and thus becomes ideal in television broadcasting as well as in FM and AM. Field testing has shown that "Level Devil" used with TV or FM without a peak limiting amplifier, has an overshoot of not more than 1 db. as observed with the application of a 10 db. increase of a complex wave input signal. While this operation is considered satisfactory for TV or FM, a peak limiting amplifier is desirable with "Level Devil" for AM operation.

**GENERAL DESCRIPTION:** "Level Devil" is a new concept in average level amplifiers that will accept input signals over a 30 db. range and hold the output constant (0 to +3 db.) over this range of input levels. Below the expander threshold "Level Devil" is a linear amplifier. At the expander threshold (—10 db. relative) the gain increases 10 db. Above this level the amplifier acts as a

## "LEVEL DEVIL" PROGRAM GATED AMPLIFIER

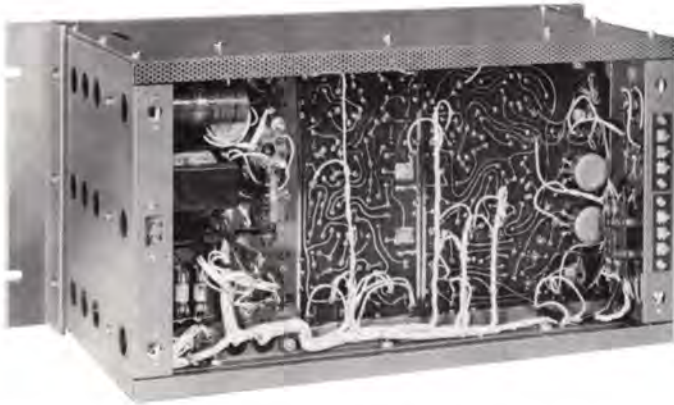

**APPLICATION:** As "Level Devil" is an improved design over all older constant level amplifiers, the application is universal wherever audio is employed. The advantages in TV and FM broadcasting are quickly understood by reason of much less expansion of background noise. Use in other services such as film, tape and disc recording offers many outstanding advantages. — "Level Devil" opens wide new areas of usage by eliminating the noise expansion objection and is recognized as an outstanding contribution to all modes of transmission.

peak limiter. However, in "Level Devil", at no signal condition, the amplifier does not return to full gain but 10 db. less. As a result, input levels as much as 10 db. below normal are expanded to normal output level but input signals below this level do not cause expansion. It can then be said that a signal to noise ratio of 13 db. or lower will not be expanded.

**SERVICING AND CONSTRUCTION:** Hinged down front panel permits complete front accessibility of components and inner servicing adjustments. Gates solid adhesion process printed wiring assures uniformity and ease in both cleaning and circuit analysis. Finish is in medium gloss gray over a heavy prime coat. Design is for continuous duty.

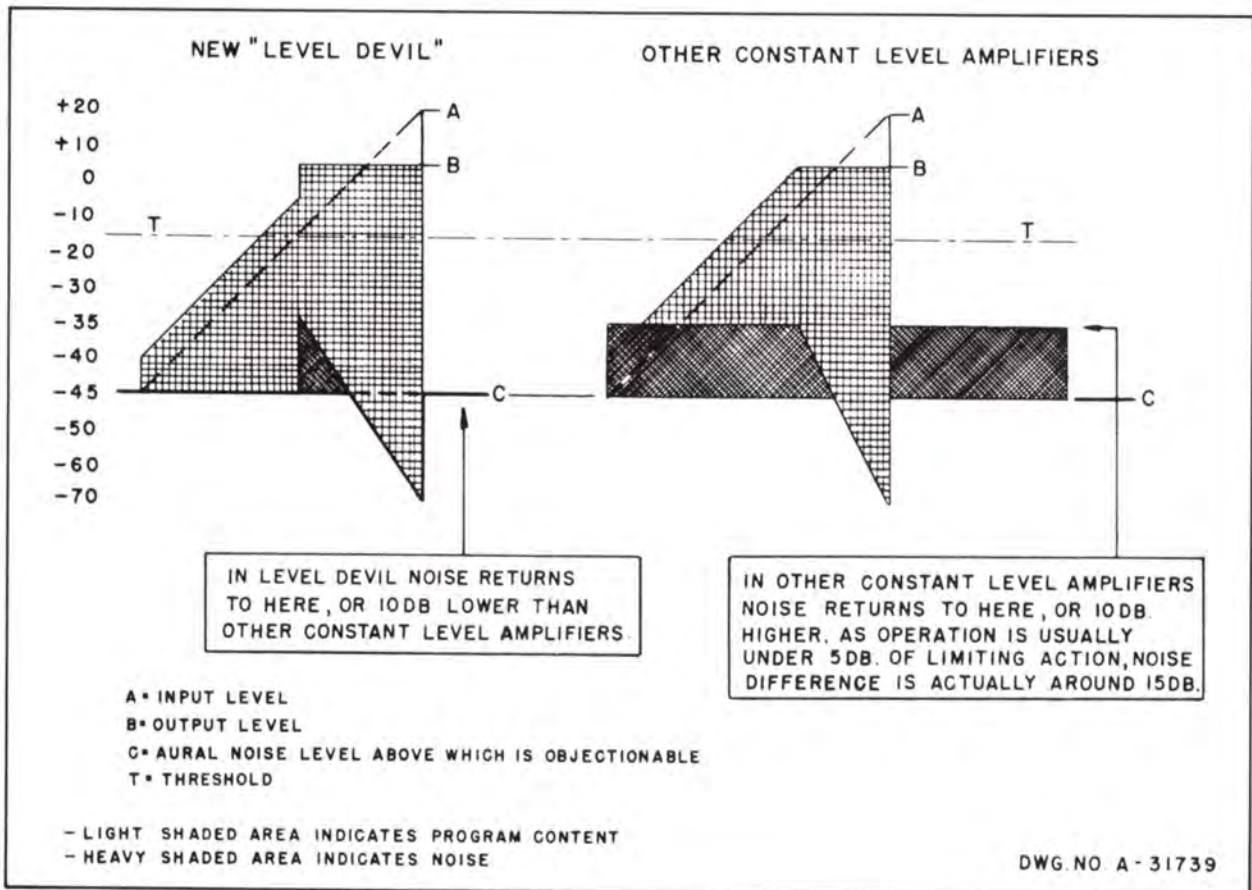



## "LEVEL DEVIL" PROGRAM GATED AMPLIFIER

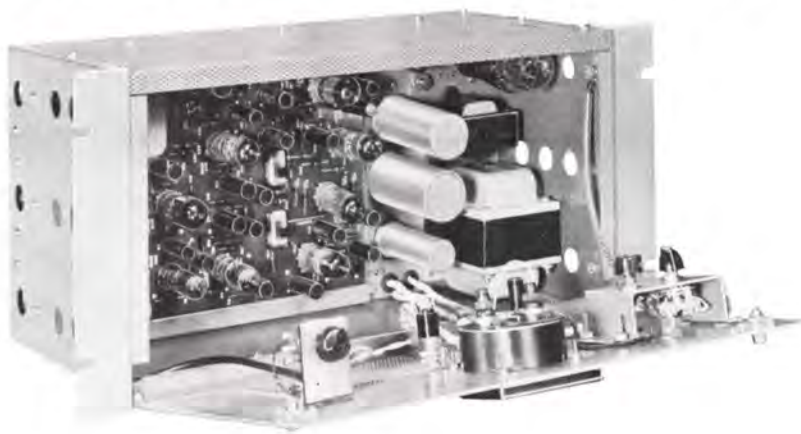

### SPECIFICATIONS

IMPEDANCES: Input and output 600 ohms.

INPUT LEVEL: -35 VU to +27 VU. (10 db. and 20 db. input, pads incorporated).

OUTPUT LEVEL: +8 VU (includes 6 db. H-type line isolation pad).

DISTORTION: 1% or less 50-10,000 cycles up to 10 db. limiting.  
2% or less up to 25 db. limiting.

RESPONSE: ±1 db. 30-15,000 cycles.

ELECTRICAL NOISE: -60 db. or better below 10 db. limiting.

MAXIMUM EXPANSION: 10 db. (NOTE: Level Devil can release 5 db. of compression and expand 10 db., giving effective signal increase of 15 db.)

POWER INPUT: 105/125 volts, 50/60 cycles at 55 watts.

FUSING: Type 3AG, 1 ampere.

SIZE: 19" wide, 8¾" high, 8½" deep.

WEIGHT: Net 28 lbs. Gross 35 lbs. — Cubage (export) 2.

TUBES: Two each 5749, 12AU7, 12AT7, 12AX7 and OB2.

One each EF86 and 5V4G.

FINISH: Medium gloss gray.

### ORDERING INFORMATION

"Level Devil" complete with tubes ..... Cat. M5546

100% spare tube kit for above ..... Cat. TK331

MAXIMUM LIMITING: 25 db.

LIMITER ATTACK TIME: 10 milliseconds.

LIMITER RELEASE TIME: 1½ to 2 seconds.

EXPANDER RISE TIME: 2 seconds.

EXPANDER RELEASE TIME: 4 seconds.

GAIN: 50 db. without expansion or limiting.

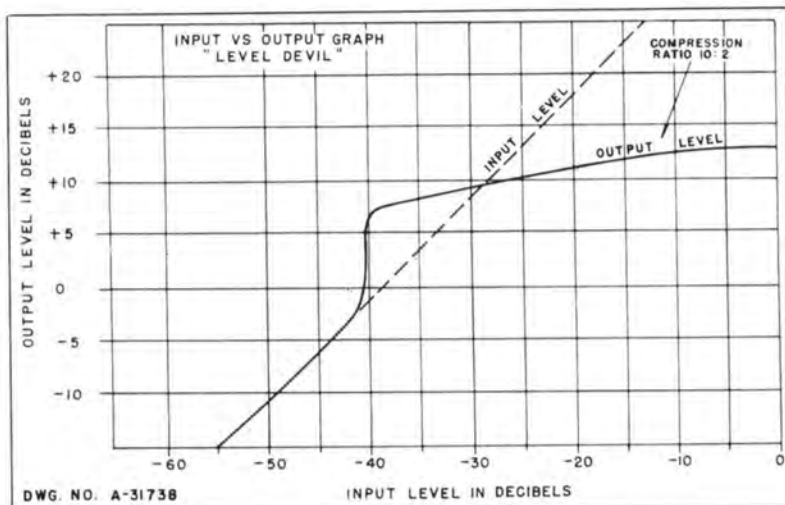

# "UNI-QUE" CUEING AMPLIFIER



In modern radio and television, many operators will agree that the cueing amplifier is equal to a third arm. It eliminates complicated control board switching and does more to prevent dead air than any other item of audio control — The Gates "UniQue" is offered in two models. A rack mount cueing amplifier with an eleven-position input switch to select "UniQue" to ten circuits and off. — The second model is desk mount and varies only by elimination of the rack housing and selector switch.

"UniQue" is a correctly designed amplifier with self-contained loudspeaker and its own silicon rectifier power

supply with such high intelligibility that voice or music is easily heard over the level of a bass reflex monitoring speaker operating at even higher level. Either low impedance or bridging input balanced and isolated requires no additional coupling transformers. The high gain permits cueing directly from turntable or microphone channels and a gain control is front panel mounted for exact adjustment.

With modern speech input systems supplying numerous cueing circuits and only requiring the cueing amplifier for completion, the Gates "UniQue" will find an urgent need in every modern broadcasting control room.

## SPECIFICATIONS

- GAIN: 70 db  $\pm$  2 db.
- DISTORTION: 3% or less, 50-10,000 cycles at +30 dbm output.
- NOISE: 50 db or better below +30 dbm output measured at -50 dbm input or mixing bus level.
- RESPONSE: Peaked for high intelligibility.
- INPUT LEVEL: At low impedance -20 dbm.  
At bridging +22 dbm.
- IMPEDANCES: Input 30/50 or 150/250 ohms.  
Bridging: 10,000 ohms.  
Output 4 ohms to terminals and strapped back to speaker so speaker line may be broken by muting relay.

- POWER: 105/125 volts, 50/60 cycles, 23 watts.\*
- TUBES: 12AX7, 50C5 and M-500 silicon rectifier.
- SIZE: Desk type: 12-1/8" wide, 3" high, 7 1/2" deep.  
Rack type: 19" wide, 3 1/2" high, 6 1/2" deep.\*\*
- FINISH: Medium gloss gray, lettering in white.
- WEIGHT: Net 10 lbs. Packed 16 lbs. Cubage 1.
- \* Power supply is transformer isolated to power line and not AC/DC.
- \*\* Rack model is supplied with 11-position input switch.

## ORDERING INFORMATION

- "UniQue" rack mount with tubes ..... M-5377
- "UniQue" desk mount with tubes ..... M-5377A
- Spare tube kit for either model ..... TK-305



New Gates cueing amplifier for desk mounting. Only 3" high, 12" wide and 7 1/2" deep, the "UniQue" consumes negligible space. Where space is very limited mounting may be on the side of a desk, attached to a turntable cabinet or any convenient location.

## PROGRAM OR LINE AMPLIFIER

In radio or television where a truly fine quality program or line amplifier is needed, the Gates M-5576 is enthusiastically recommended. Incorporating the proven, long-lasting uniformity of printed wiring and the resulting entire elimination of parts stacking, the clean construction for easy servicing is only excelled by day-in day-out steady top quality performance.

Amplifier has four stages with a dual grid gain control, having one section in the grid of the second stage and the second section in the grid of the third stage. In this manner the lowest noise ratio is always maintained. The front panel drops down to reach all under chassis components. Front panel equipment includes gain control, AC switch, fuse and neon pilot light.

Screw-type terminals on the rear are located for good rack wiring practice with AC terminated to a barrier type terminal board. A hum balance control, which the M-5576 incorporates, is necessary in precise broadcasting. Features of the M-5576 amplifier are the sterling performance, extremely firm specifications and durability.

### ORDERING INFORMATION

Program or line amplifier complete with tubes M-5576  
100% spare tube kit for above ..... TK-304



### SPECIFICATIONS

GAIN: 75 db  $\pm$  2 db.  
DISTORTION: 0.5% or less 50-15,000 cycles at +12 dbm output.  
0.75% or less 30-15,000 cycles at +12 dbm output.  
1% or less 50-15,000 cycles at +22 dbm output.  
RESPONSE:  $\pm$  1.5 db from 30 to 15,000 cycles.  
NOISE: 60 db or better below -60 dbm input at +12 dbm output or equivalent to -120 dbm relative input noise.  
IMPEDANCES: Input 150/250 or 500/600 ohms. Output 150/250 or 500/600 ohms.  
TUBES: (3) 5879, (1) 12AU7, and (1) 6X4 rectifier.  
POWER: 105/125 volts, 50/60 cycles, 15 watts.  
SIZE: 19" wide, 5 1/4" high, 7 1/2" deep.  
WEIGHT: Net 12 lbs. Packed 27 lbs. Cubage 2.

## ULTRA LINEAR MONITORING AMPLIFIER



In today's broadcasting the need for excellence in loud-speaker distribution systems is apparent. Here is an amplifier that is ahead of the finest loudspeaker system developing a guaranteed 1% or less distortion at +40 dbm output or 10 watts.

Unusual in monitoring amplifiers is the high gain of 100 db, yet the usual provision for bridging a +8 dbm program line is incorporated. With high gain, this amplifier may be used directly from a mixer program bus, a low level turntable or microphone. The M-5575 amplifier has been designed for all monitoring requirements.

Actually two amplifiers comprise the total unit. A two-stage monitor booster amplifier operates ahead of the three-stage monitoring amplifier, with the gain control between the two amplifiers. The ultra linear output circuit and dual EL84 tubes, driven by a floating paraphase phase inverter where audio drive voltage is maintained constant, provides the undisputed 1% 10-watt output.

The front panel drops down to reach all under-chassis

parts. Panel equipment includes gain control, AC switch, pilot light and fuse. Terminations are to screw type terminals with AC to an approved barrier strip. Hum balance control is reached by dropping down the front panel.

Though designed specifically for the precise needs of radio and television broadcasting, the discriminating user of sound for industry, theatre, schools and home will possess the ultimate in sound amplifying equipment in the Gates M-5575 amplifier.

### SPECIFICATIONS

GAIN: Maximum, 100 db  $\pm$  2 db. Bridging, 50 db  $\pm$  2 db.  
DISTORTION: 1% or less 50-15,000 cycles at +40 dbm output (10 watts).  
RESPONSE:  $\pm$  1 1/2 db, 30-15,000 cycles.  
NOISE: 60 db or better below +40 dbm measured at -50 dbm input.  
IMPEDANCES: Input 30/50 or 150/250 at full gain of 100 db. 30,000 ohms at gain of 50 db. Output 8 or 16 ohms (see matching transformer below).  
TUBES: (3) 12AX7, (2) EL84, (1) GZ34 or 5V4, (1) OA2, (1) OB2.  
POWER: 105/125 volts, 50/60 cycles, 85 watts.  
SIZE: 19" wide, 7" high, 8" deep.  
WEIGHT: Net, 18 lbs. Packed, 34 lbs. Cubage 2 1/2.  
SPEAKER MATCHING TRANSFORMER: Optional accessory where many speakers are employed. Primary 48 ohms. Secondary 8 ohms. Permits loading as many as 8 speakers to output of amplifier. Transformer is installed with speaker... (Cat. A-30601)

### ORDERING INFORMATION

Ultra Linear Monitoring Amplifier ..... M-5575  
100% spare tube kit for above ..... TK-303

# THE "DYNAMOTE" PORTABLE REMOTE AMPLIFIER



"Dynamote" has been symbolic of remote amplifying equipment for nearly a quarter century. The name originated back when the dynamic microphone was first introduced. Today's "Dynamote" is compact, modern, easy to operate and portable. Weighing only 22 pounds, it measures 5 $\frac{7}{8}$ " high, 10 $\frac{1}{4}$ " wide and 17 $\frac{3}{4}$ " deep with battery compartment attached. Hinged illuminated 4" VU meter, which folds in when not used, swings to exact eye level for easy reading.

Four mixing channels handle four or less low impedance microphones of any type. After normal mixer and isolation pad loss is subtracted from the total amplifier gain, an abundant 90 db of gain remains to assure you of pick-up that other remote amplifiers do not afford. Printed wiring, not to be confused with printed circuit, adds greatly to reliability, and smaller size. Battery standby, with automatic changeover in case of power failure, is an optional accessory. Symbolic of superb performance, nothing has been sacrificed to put the Dynamote in a class by itself.

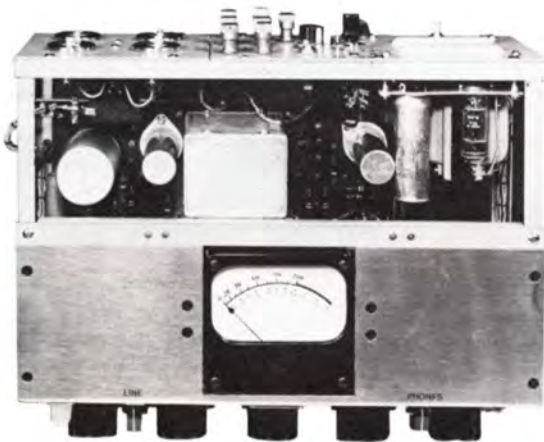

Looking down on the Dynamote when removed from the case showing accessibility of parts for servicing. Entire unit is constructed in rigid, lightweight frame. In this way the carrying case does not become part of the mechanical design.



Back of the Dynamote handles all connections, microphones and even holds the Off-On switch. Receptacle in center is for accommodating the optional M-4933 battery unit.

## THE "DYNAMOTE" PORTABLE REMOTE AMPLIFIER

The Dynamote is constructed around a small, light-weight, welded frame to which attaches the amplifier, power supply, front panel with controls and meter, and the back panels for connectors and terminations. This slips into a rugged carrying case made of durable basswood, covered with a heavy grade of gray leatherette. A large leather handle, and hardware in nickel, add the finishing touch.

Amplifier design has four audio stages and 15 db of feedback is employed. A full output of plus 22 dbm at 1% distortion is obtained. A 4 db output isolation pad provides a final maximum output of plus 18 dbm at no more than 1% distortion, or a 10 db range above the maximum permissible level of plus 8 dbm into a telephone

line. Mixing controls are Daven, ladder type, 20 steps of 2 db. Input is either 50 or 150 ohms.

When batteries are employed for standby, the M-4933 Continumatic adapter is purchased plus the M-4983 kit of batteries. The M-4933 adapter includes relay, metal-hinged battery compartment, cable and plug, all of which fit in the removable rear case compartment. Changeover to batteries is automatic when AC fails. Reverse is true when AC is restored.

The Dynamote is cataloged with the microphone connector plate but less microphone plugs. The entire plate of 4 connectors plugs into the amplifier chassis. No wiring is required on receipt of the equipment.

### SPECIFICATIONS

NUMBER OF MIXING CHANNELS: 4

GAIN: From remote input to program line output 90 db  $\pm$ 3 db.

AUDIO RESPONSE:  $\pm$ 1.5 db 30-15,000 cycles (program circuit).

OUTPUT LEVEL: Program line maximum of +18 dbm at 1% distortion.

NOISE: 60 db below +8 dbm measured at -50 dbm input. Equivalent input noise is -110 dbm.

CROSSTALK: Below noise level (from other microphones).

SIZE: 10 $\frac{1}{4}$ " wide, 17 $\frac{3}{4}$ " deep, 5 $\frac{7}{8}$ " high.

WEIGHT: Net weight 22 lbs., packed at 25 lbs.

CUBAGE: 2.8 cu. ft.

PRIMARY POWER: 115 volts, 50/60 cycles.

POWER CONSUMPTION: 40 watts.

TERMINATIONS: Microphone plugs, telephone line binding posts.

FINISH: Medium gloss gray panel with black knobs and escutcheons, gray leatherette case.

VU METER: 4" VU scale B illuminated, adjusted 0 VU indication at +8 dbm.

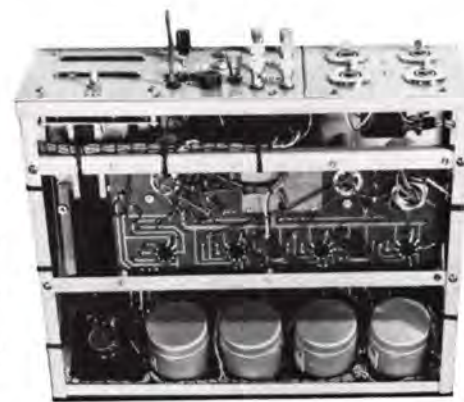

Left: Rear view with M-4933 battery compartment placed on top.

Center: M-4933 battery compartment with M-4983 battery kit.

Right: Under view of Dynamote showing clean assembly by printed wiring.

### ORDERING INFORMATION

Dynamote with tubes, Cannon XL receptacles and carrying case .....	M-4880A
Dynamote with tube, Cannon P receptacles and carrying case .....	M-4880B
Continumatic battery compartment with relay and plug, less batteries .....	M-4933
100% spare tube complement .....	TK-183
Microphone plug for XL receptacles, each .....	XL3-12
Microphone plug for P receptacles, each .....	P3CG125
100% set of batteries .....	M-4983

# "BIAMOTE" — TWO CHANNEL REMOTE AMPLIFIER

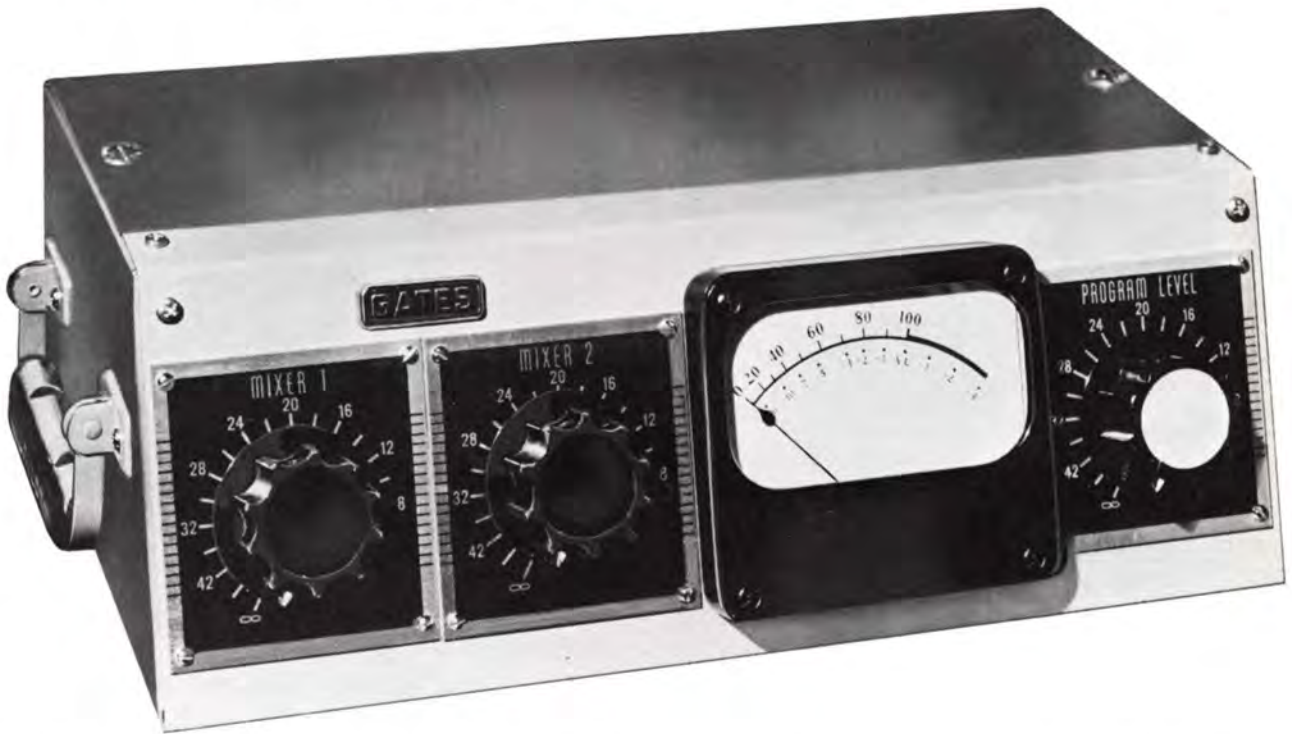

Remote pickups for either radio or TV probably call for more 2-microphone installations than any other combination. The "Biamote" fills this requirement with fine performance, light weight, rugged design, and a full complement including a 4" illuminated VU meter.

Constructed in a rugged, light-weight steel cabinet finished in gloss gray with dial plates in etched aluminum. Total weight is only 15¼ lbs. ready to use. Top removes quickly and is held in place with two twist lock fasteners. Front panel slopes at approximately 12 degrees and height is only 5 inches, permitting unobstructed view of any

broadcasting event. The full size 4" illuminated VU meter is retained. "Biamote" design is functionally correct with the dual ladder type mixers to the left of the VU meter and the master gain control to the right of the meter.

All terminations are to the rear, including Off-On switch, line connections, headphone jack, microphone receptacles and power cord. Cannon type XL receptacles are standard, but larger knock-outs are provided for such connectors as the Cannon P series. These may be installed in a few minutes, where desired. A full size hinged handle is provided on one side of the amplifier case.

## SPECIFICATIONS

NUMBER OF MIXING CHANNELS: 2.  
 IMPEDANCE: Input 50/150 ohms.  
                   Output 500/600 ohms.  
 GAIN: From microphone input to program line output,  
       90 db +3 db from microphone input to line terminals.  
 AUDIO RESPONSE: +2 db 30-15,000 cycles.  
 HARMONIC DISTORTION: 1% or less 50-15,000 cycles +18 dbm output.

NOISE: 60 db or better below +8 dbm measured at —50 dbm input. Equivalent to —110 dbm measured.  
 SIZE: 14" wide, 8½" deep, 5" high.  
 WEIGHT: 15¼ lbs.  
 PRIMARY POWER: 115 volts, 50/60 cycles.  
 POWER CONSUMPTION: 40 watts.  
 FINISH: Medium gloss gray.  
 VU METER: Illuminated 4" full scale standard NAB VU meter.

## ORDERING INFORMATION

"Biamote" with tubes, less male microphone connectors ..... M-5136  
 Male microphone connector, each ..... XLE-12  
 100% spare tube complement for above ..... TK-183

# THE "TWINSISTOR"—TRANSISTORIZED REMOTE AMPLIFIER

With efficient, long life, temperature stabilized transistors, the Gates "Twinsistor" is the smallest, lightest, multi-channel remote amplifier, and the only transistorized dual-channel remote on the market today. Total weight with carrying case is only 7 lbs. Size is: 7½" wide, 7" deep and 3⅛" high. In addition, low current, mercury batteries, two microphone channels, true reading VU meter, and generous gain make the "Twinsistor" ideal for any situation.

Superior in performance, noise is comparable to good tube design. Response exceeds and distortion is far less than most grade A telephone lines. A plastic carrying bag of the camera type is 10½" wide, 8" high, 3½" deep. Has adjustable shoulder strap. Bag will hold amplifier, headphones and one average microphone with cable. Six transistors comprise a 4-stage temperature stabilized amplifier with push-pull output. Amplifier holds two battery kits. Changeover switch is on rear of case. Microphone receptacles are Cannon XL. Meter is standard 3" VU with fixed



pad for +8 VU output at zero scale. Master gain is not required in transistor design and attenuators may be operated at any setting without overload or noise increase. Amplifier turns on when headphones are inserted in jack.

## SPECIFICATIONS

**NUMBER OF MIXING CHANNELS:** 2 at high level (transistor pre-amp for each stage).

**IMPEDANCES:** 150/250 ohm input (just less gain when using 30/50 ohm microphones). 600 ohm output.

**GAIN:** From microphone input to program line output 78 db ±2 db.

**AUDIO RESPONSE:** ±2 db 70-15,000 cycles. (Program circuit).

**OUTPUT LEVELS:** Program line maximum of +14 dbm at 2% distortion.

**NOISE:** 55 to 60 db or better below +14 dbm measured at -60 dbm input. Equivalent input noise is -115 to -120 dbm.

**SIZE:** 7½" deep, 7" wide, 3⅛" high.

**WEIGHT:** 7 lbs. (in case). 5½ lbs. (less case).

**CUBAGE:** 1.0 cu. ft.

**BATTERIES:** M-5339 mercury battery kit. Provisions to have two kits with changeover switch.

**BATTERY LIFE:** Approximately 80 hrs.

**TERMINATIONS:** Microphone plugs, program line binding posts.

**FINISH:** Medium gloss gray.

**VU METER:** Standard 3" VU with fixed pad for +8 VU output at "zero" scale.

## ORDERING INFORMATION

"Twinsistor" complete with carrying case and one set of batteries .....	M-5168
Male microphone connector (2 required), each .....	XL3-12
Battery kit in container and wired .....	M-5339
Microphone with swivel to plug in back of "Twinsistor"* .....	M-5332

\*Microphone Electro-Voice 648.

# THE "UNIMOTE" REMOTE AMPLIFIER



Here is broadcasting's fastest selling single microphone AC operated remote amplifier. Designed to particularly fill the universal need of a fine performing, dependable and compact remote control amplifier, the M-5531 "Unimote" will perform equally well as a microphone preamplifier, turntable preamplifier, program amplifier up to +18 dbm output, repeater amplifier, isolation amplifier and as a standby amplifier for quick connection to an emergency circuit.

Size is only 11" wide, 5 $\frac{3}{4}$ " high and 5" deep. Cover removes for 100% accessibility by two snap locks. Printed wiring is employed throughout for uniformity and dependability.

## SPECIFICATIONS

IMPEDANCES: Input 30/50 or 150/250 ohms.  
Output 150/250 or 500/600 ohms.

GAIN: From microphone input to program line output,  
81 db  $\pm$  2 db.

AUDIO RESPONSE:  $\pm$ 1 $\frac{1}{2}$  db from 30-15,000 cycles  
(program circuit).

OUTPUT LEVELS: Program line maximum of 1% distortion at +8 dbm.  
Program line maximum of 1 $\frac{1}{2}$ % at +18 dbm.

NOISE: 60 db or better below +8 dbm measured with  
-60 dbm input or -120 dbm relative input noise.

TUBES: (2) EF86, (1) 12AU7 and (1) 6X4 rectifier.

SIZE: 11" wide, 5" deep, 5 $\frac{3}{4}$ " high.

WEIGHT: 11 lbs.

CUBAGE: 1.0 (cu. ft.)

PRIMARY POWER: 105/125 volts, 50/60 cycles.

POWER CONSUMPTION: 15 watts.

FINISH: Medium gloss gray.

## ORDERING INFORMATION

"Unimote" Amplifier with tubes .....	M-5531
100% spare tube kit for above .....	TK-280
Microphone connector (male), Cannon .....	XL3-12



# THE "AUTOMOTE" TRANSISTORIZED REMOTE AMPLIFIER



Transistorized for long life and top grade performance, the single channel "Automote" allows complete control from the studio by the use of a wall switch located on or near the studio control board. A neon pilot light tells the artist when he is "on" and "off" air.

The "Automote" can be used as a microphone preamplifier with inbuilt warning light for the studio that is around the corner from the control room or on another floor. It can be used as a microphone amplifier in connection with tape recorders — it tells artist when recording engineer is ready. In its basic use, it is ideal in places such as churches, ballrooms and sports areas because of positive cue and no dead air.

Able to operate for 80 hours on a set of inexpensive batteries, the remote operation is entirely unattended. Each stage is temperature stabilized for operation up to 140° F. Special techniques applied develop low distortion, wide dynamic range and very low noise.

All controls and terminations are inside the cabinet which is provided with lock and key. In this way, control functions cannot be tampered with. The only external device is the "on air" light. Cabinet may be bolted to the wall or placed on a desk, as desired.

A small, sensitive, low current relay, located in the amplifier cabinet, receives its current from the two small batteries, also in the cabinet. When the telephone line is closed at the studios, the relay operates, turning on the transistor amplifier and neon "on air" light. Likewise, when the circuit is opened at the studios, the relay opens, amplifier and "on air" light turn off. The very finest broadcast quality is obtained while the end result is the same as the artist being in an adjoining studio and often missed aural cues are dispensed with.

Tests have been conducted using "Automote" on 47 miles of line, as operation is based on 10,000 ohms maximum resistance. Lines up to 100 miles in length would be possible providing no repeater was in the telephone line circuit.

## SPECIFICATIONS

MIXING CHANNELS: 1

IMPEDANCES: Input 150/250 ohms  
Output 500/600 ohms

GAIN: From microphone input to program line output  
78 db  $\pm 2$  db

AUDIO RESPONSE:  $\pm 2$  db, 50 to 10,000 cycles

OUTPUT LEVEL:  $\pm 14$  dbm

HARMONIC DISTORTION: 2% or less 50-10,000 cycles.

NOISE: 55 to 60 db below +14 dbm measured at -60 dbm input

SIZE: 10 $\frac{1}{2}$ " wide, 8 $\frac{1}{2}$ " deep, 4 $\frac{1}{2}$ " high

WEIGHT: 9 $\frac{1}{4}$  lbs.

PRIMARY POWER: Batteries — (2) XX30, 45 volt, and (1) M-5339 Gates mercury battery pack

FINISH: Medium gloss two-tone gray

## ORDERING INFORMATION

Automote remote amplifier complete with one set of batteries and switch box .....	M-5500
Microphone connector (male) .....	XL3-12
Spare mercury battery kit .....	M-5339
Spare relay battery (2 required) .....	XX30

# THE TRANSMOTE — TRANSISTORIZED SINGLE CHANNEL REMOTE



close the carrying case without removing the phone plug and turning off the amplifier voltage.

Leather carrying case has adjustable shoulder strap that is removable. Case will fit suit coat or overcoat pocket. Here is compact, top-performing equipment, with all the desirable features of transistors.

## SPECIFICATIONS

- IMPEDANCES: Microphone input 150/250 or 30/50 ohms.  
Headphone output impedance, 600 ohms.
- GAIN: From microphone input to program line output: 78 db  $\pm 2$  db.
- AUDIO RESPONSE:  $\pm 2$  db from 50 to 10,000 cycles.
- OUTPUT LEVEL: +14 dbm to program line with 2% maximum distortion from 70 to 10,000 cycles.
- NOISE: 55 to 60 db below +14 dbm measured at -60 dbm input.  
Equivalent input noise -115 to -120 dbm.
- SIZE: (carrying case) 3 1/2" wide, 2 1/2" deep, 9 1/2" high.  
(less carrying case) 3" wide, 1 7/8" deep, 8 5/8" high.
- WEIGHT: 3 lbs. net with case.
- CUBAGE: 1.0 cu. ft.
- PRIMARY POWER: (3) 8 volt mercury batteries in kit M-5339.
- FINISH: Medium gloss gray cabinet, brown leather carrying case.

Outstanding features of the "Transmote" are: Very small size extreme light weight non-microphonic battery operation, and long life, low cost battery operation.

Five transistors are used in 4 temperature stabilized stages, the output stage being push-pulled. Level control, headset jacks, microphone receptacle, gain control and output binding posts are all properly located for both portable or stationary service. Amplifier turns on when phones are inserted in jack. A plastic jack plug is provided where phones are not used. It is impossible to

## ORDERING INFORMATION

- Transmote with carrying case, one set batteries ..... M-5311
- Transmote less carrying case, with batteries M-5311A
- Complete spare battery kit\* ..... M-5339
- Mating microphone connector ..... XL3-12

\*Wired, in container, ready to insert.

## THE TUBELESS TUBE

Often in TV production, or longer than normal lines, it is desirable to raise the potential gain of a microphone circuit. The tubeless tube, a small transistorized amplifier, does just this. Designed to connect at any place into the microphone cable such as on a boom stand, it may be placed on the floor being non-microphonic. It is built into an aluminum tube 2" in diameter and 4 1/2" long. Cannon XL receptacles are on each end. As the battery drain is extremely low, the tubeless tube may be turned on and left on for over a year before changing batteries. Batteries are self-contained. Set screw in case functions as On-Off switch, used only when storing. Design is a single stage transistor, which is temperature stabilized. Finish is in gray.



## SPECIFICATIONS

- GAIN: 15 db  $\pm 1$  db with 150/250 ohm microphones.
- FREQUENCY RESPONSE:  $\pm 3$  db 70-15,000 cycles.
- DISTORTION: Under 0.5% from 70 to 15,000 cps at -45 dbm output.
- NOISE: 58 to 65 db or better below -60 dbm input level, or -118 to -125 dbm equivalent input noise.
- SOURCE IMPEDANCE: 150/220 ohms.
- OUTPUT IMPEDANCE: 50/150 ohms.

## ORDERING INFORMATION

- Tubeless Tube, with batteries ..... M-5312
- Mating input connector ..... XL3-12
- Mating output connector ..... XL3-11
- Battery kit ..... M-5350

# M-5530 ALL-PURPOSE UTILITY AMPLIFIER



The Gates all-purpose Utility Amplifier with self-contained power supply may be used for many different services in radio and television. Incorporating standard broadcast coupling impedances along with high-quality components and printed wiring, reliability and performance are outstanding.

The M-5530 Utility Amplifier May Be Used As:

- A single channel remote amplifier with nothing else to buy except microphone and XL3-13 microphone connector.
- A high gain, low noise turntable preamplifier possessing the extra gain needed for modern low level pickups through passive equalizers.
- A line, repeater or program amplifier with performance standards approaching the very best.
- A standby, ready to patch in where needed.
- A microphone amplifier for feeding professional high level input tape recorders.

The M-5530 amplifier is a direct, modern replacement for the famous Gates SA-134 amplifier, of which thousands are in use. From low impedance input through the 81 db of gain to a choice of output impedances is embodied the finest of materials. Reliable performance is emphasized through the uniformity and lasting qualities of printed wiring, a low flux density power transformer, high shielded input transformer and the mandatory requirement of more rugged smaller parts when applied to the printed wiring process.

The entire unit is made on one printed wiring formica plate and one aluminum plate. These plates are mounted

in a 16 gg. steel chassis. This chassis contains the terminations, gain control and fuse. On the left end a knock-out is provided for a standard Cannon XL3-13 connector for attaching a microphone if used as a remote amplifier. The right end has a barrier strip for AC connection and fuse.

## SPECIFICATIONS

- IMPEDANCES: Input 30/50 or 150/250 ohms.  
Output 150/250 or 500/600 ohms.
- GAIN: From microphone input to program line output 81 db  $\pm 2$  db.
- AUDIO RESPONSE:  $\pm 1\frac{1}{2}$  db, 30 to 15,000 cycles.
- NOISE: 60 db or better below +8 dbm output measured at -60 dbm input. Equivalent input noise is -120 dbm.
- DISTORTION: 1% or less 50 to 15,000 cycles @ +8 dbm output.  
 $1\frac{1}{2}\%$  or less 50 to 15,000 cycles @ +18 dbm output.
- TUBES: (1) EF86 1st audio (1) EF86 2nd audio, (1) 12AU7 3rd audio (1) 6x4 rectifier.
- TOTAL TUBES: 4
- TOTAL TUBE TYPES: 3
- SIZE: 11" wide,  $5\frac{3}{4}$ " deep, 5" high.
- WEIGHT: 6 lbs. net, 9 lbs. packed.
- CUBAGE: 1.6.
- PRIMARY POWER: 105-125 volts, 50/60 cycles.
- POWER CONSUMPTION: 15 watts.
- TERMINATIONS: Terminal strips.
- FINISH: Medium gloss gray.

## ORDERING INFORMATION

- Model M-5530 all-purpose utility amplifier  
with tubes ..... M-5530
- Spare 100% spare tube complement for above TK-280  
Chassis connector where used with microphone XL3-13  
Microphone plug for above chassis connector.. XL3-12

# PLUG-IN PREAMPLIFIER — PROGRAM AMPLIFIER — BRIDGING CONTROLS



## PRE-4 AMPLIFIER

**GAIN:** 40 db  $\pm$ 1 db.  
**DISTORTION:** 0.5% or less 50-15,000, 0.75% or less at 30 cycles. Measured at +8 dbm output.  
**NOISE:** 90 db below +10 dbm output (-120 to -124 dbm equivalent input noise).  
**LEVELS:** Maximum input -32 dbm. Maximum output at above rated distortion, +8 dbm.  
**IMPEDANCES:** Input 150 and 250 ohms. Output 150 and 600 ohms. As input transformer is unloaded, the impedance is substantially higher than source impedance over entire range.  
**POWER:** Requires 6.3 volts AC or 0.3 amperes and 275/310 volts DC at 6 MA.  
**TUBES:** Two type 5879.  
**CIRCUIT:** Two-stage shunt fed output. Over-all feedback from plate of second stage to cathode of first stage.  
**MECHANICAL:** Size 2 1/16" x 11 1/2" x 5 3/8" high overall. Mounts eight in one PAS-1 panel and shelf assembly. One PWR-3 power supply will operate up to 26 preamplifiers.

Preamplifier with Tubes ..... PRE-4  
 100% Spare Tube Complement ... TK-112  
 Base and Receptacle ..... BA-20



## PANEL AND SHELF ASSEMBLY

Used for rack or multiple mounting of plug-in units. Requires only 7" x 19" rack space. Front is ventilated by top half being perforated and is instantly removable to allow removing amplifiers from the front, or making gain adjustments. The BA-20 or BA-21 bases with receptacle, listed below, fasten to the bottom of the panel and shelf assembly. Depth is 13 3/8". Finish medium gloss gray.

Panel and Shelf ..... PAS-1



Here are 8 plug-in preamplifiers mounted on one PAS-1 panel and shelf assembly, requiring only 7" x 19" of rack space. Self-aligning plugs and receptacles allow unlimited interchange of amplifiers without resetting plugs or receptacles.

## BRIDGING CONTROLS

For use with all Gates plug-in amplifiers where bridging input is preferred over direct impedance matching. As all bridging controls insert various degrees of loss in the circuit, this should be taken into consideration. Two high quality carbon controls in tandem, balanced to ground, make up each control. Mounting is external to amplifier.

- AT1 Control, 10,000 ohms to 150 ohms
- AT2 Control, 10,000 ohms to 600 ohms
- AT3 Control, 20,000 ohms to 150 ohms
- AT4 Control, 20,000 ohms to 600 ohms

## PGM-4 PROGRAM AMPLIFIER

**USE:** As high quality program or line amplifier where output up to +24 dbm at low distortion is desired. One or two of these amplifiers will operate from a single PWR-3 regulated power supply listed on next page.

**GAIN:** 65 db as a line or program amplifier, direct matching of impedances. Where used as bridging amplifier with AT2 bridging volume control, the gain is 33 db.

**RESPONSE:**  $\pm$  db 30-15,000 cycles.  
**DISTORTION:** 0.5% 50-15,000 cycles. 0.75% or less at 30 cycles, at +24 dbm output.  
**NOISE:** 79 db or better below +24 dbm output with volume control fully open. (-120 to -124 equivalent input noise).



## BASE AND RECEPTACLE

Two bases accommodate all plug-in units. Model BA-20 is for all pre-amplifiers. BA-21 is for program and monitoring amplifiers and PWR-3 regulated power supply. Mounts on bottom of PAS-1 panel and shelf assembly. Where other mounting desired may be secured to any panel, base of desk, or wood cabinet. Supplied with receptacle.

Base and Receptacle ..... BA-20  
 BA-21

**LEVELS:** Maximum input +8 dbm. Maximum output +24 dbm.  
**IMPEDANCES:** Input 150 and 600 ohms. Output 600, 150 ohms.  
**POWER:** 6.3 volts AC at 1.05A and 300/330 volts DC at 37 MA.  
**TUBES:** Three 12AU7 and one 5879.  
**CIRCUIT:** Three stages with push-pull output. Feedback between second and third stages.  
**MECHANICAL:** Cold rolled steel chassis, die formed and heavily plated.  
**SIZE:** 4 1/8" x 11 1/2" x 6 5/8" high overall. Type PWR-3 power supply will operate from one to four of these program amplifiers.

- Program amplifier with
- tubes ..... PGM-4
  - Base and receptacle ..... BA-21
  - 100% spare tube complement ..... TK-122



# PLUG-IN MONITORING AMPLIFIER AND POWER SUPPLY

## MON-4 MONITORING AMPLIFIER

**USE:** For loudspeaker distribution, recording and auxiliary program amplifiers. High gain allows use with bridging controls or other loss circuits. One PWR-3 power supply and one PWR-10 bias supply, listed below, will operate one or two MON-4 monitoring amplifiers or one monitoring amplifier, one program amplifier and four preamplifiers.

**GAIN:** As straight amplifier, 103 db. When used with AT2 bridging control, 70 db.

**RESPONSE:** ±2 db 30-15,000 cycles.

**DISTORTION:** 3% or less at +37 dbm with gain control fully open. (Equivalent input noise -120 to -124 db).

**LEVELS:** Maximum input -27 dbm. Maximum output +37 dbm.

**IMPEDANCES:** Input 150 and 600 ohms. Output 600, 150, 16, 8 and 4 ohms.

**POWER:** 6.3 volts AC at 1.5A and 320/340 volts DC at 85 MA.

**TUBES:** Two each 5879, 6AQ5 and one 12AU7.

**CIRCUIT:** Four-stage with push-pull output. Tertiary winding feedback from secondary of output transformer to cathode of driver stage.

**MECHANICAL:** Cold rolled steel chassis, die formed and heavily plated. Size: 4 1/8" x 11 1/2" x 6 3/8" high overall. One PWR-3 power supply, with one PWR-10 bias supply, will operate one or two of these monitoring amplifiers.



Monitoring amplifier with tubes .....	<b>MON-4</b>
Base and receptacle .....	<b>BA-21</b>
100% spare tube kit .....	<b>TK-121</b>

## PWR-3 REGULATED POWER SUPPLY

**USE:** An unusually well regulated power supply with very low ripple content. Where used with MON-4 monitoring amplifier, the PWR-10 bias supply should be ordered. Bias supply not required for preamplifiers or program amplifiers.

**CAPACITY:** Will supply up to 26 PRE-4 preamplifiers, four PGM-4 program amplifiers, two MON-4 monitoring amplifiers or any combination of the above.

**POWER:** Supplies 6.3 volts AC at 8A, 310/350 volts DC at 0-160 MA. With PWR-10 bias unit added, supplies 15 volts DC at zero current. For 115 volts, 50/60 cycles. 230 volt design available on special order.

**INTERNAL IMPEDANCE:** Negligible.

**INTERNAL REACTANCE:** Negligible.

**RIPPLE CONTENT:** Less than 0.002 volts or 0.0006% through entire voltage range.

**TUBES:** One each 5V4G, 5879, 6080, and two OA2.

**MECHANICAL:** Cold rolled steel chassis, die formed and plated. Hum balance control on filament circuit and voltage output control on front. Size: 4 1/8" wide, 11 1/2" front to back, 6 3/8" high. Mounts four in a panel and shelf assembly.



Power supply with tubes .....	<b>PWR-3</b>
Base and receptacle .....	<b>BA-21</b>
100% spare tube kit .....	<b>TK-103</b>



**PWR-10  
BIAS SUPPLY**

Plugs into socket provided on PWR-3 regulated supply to provide bias voltage to one or two MON-4 monitoring amplifiers. Not required for preamplifiers or program amplifiers. Where bias supply is used this does not restrict power supply for use with monitoring amplifiers only. Amplifiers may be mixed as desired.

Bias supply .....	<b>PWR-10</b>
-------------------	---------------

### When Ordering Plug-In Equipment —

It is necessary to order the BA-20 or BA-21 base/receptacle unit for each amplifier. It is not necessary to order the base/receptacle unit where amplifiers or power supplies are purchased as spares. — All amplifiers are so well shielded that power supplies may be operated on the same panel and shelf assembly with only normal precautions necessary.

# V-22 VU PANEL, SWITCH FUSE, AUDIO PATCH PANELS

## V-22 VOLUME INDICATOR

A complete range set with 10 position input select-or switch. In this way, all circuits to be measured may be switched in, including proof of performance. Meter is 4" illuminated. Range control in 2 VU steps from +4 to +42 VU. Input impedance 7500 ohms to bridge at 500/600 ohm line. Panel 5 1/4" x 19". Finish, medium gloss gray.



## SWITCH AND FUSE PANEL

Used for turning On-Off all equipment in one relay rack. Two 30A plug fuses mount behind snap-on front panel.



Includes indicator lamps and 15A switch.



Size: 3 1/2" x 19".

Finish: Medium gray.

SWITCH PANEL ..... M-4242



## PATCH PANELS

Industry standard double patch assemblies. Jack strips listed separately from jack mats for ease in ordering. All jacks closed circuit type for non-malling through audio circuits. Non-aging, non-ferrous metal assures long lasting spring tension. Contacts of silver alloy. Jacks held by molded bakelite, steel reinforced. Individual designation strips with slip-in holders for each pair of jacks.

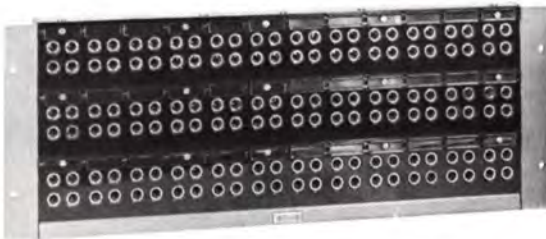

Above, three PJ-341 jack panels mounted on PD3 jack mat. Has 144 jacks (72 pairs). Panel Size: 7" x 19".

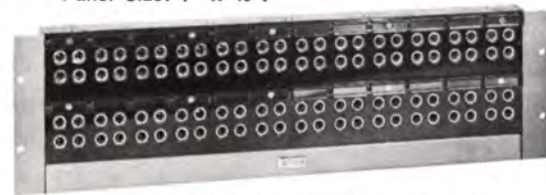

Above, two PJ-341 jack panels mounted on PD2 jack mat. Has 96 jacks (48 pairs). Panel size: 5 1/4" x 19".



Above, one PJ-341 jack panel mounted on PD1 jack mat. Has 48 jacks (24 pairs). Panel size: 3 1/2" x 19".

- Jack strip (24 jacks) with mounting brackets ..... PJ-343
- Jack strip (48 jacks) less mat .... PJ-341
- Jack mat for one C-1500 jack strip ..... PD1
- Jack mat for two C-1500 jack strips ..... PD2
- Jack mat for three C-1500 jack strips ..... PD3
- Patch cord 2' long ..... PJ12
- Patch cord 3' long ..... PJ13
- Patch cord 4' long ..... PJ14
- Patch cord 5' long ..... PJ15



Patch cords available in four lengths. Double plugs each end. Shielded and covered with durable black braid plus extra reinforcement 6" from each end.



Above, PJ-343 jack panel has 24 jacks (12 pairs). Size: 1 3/4" x 19". Does not require jack mat. End brackets for rack mounting supplied.

# AUDIO EQUALIZERS — SOUND EFFECTS FILTERS



A precision equalizer available in 5 ranges as listed below. Has twenty 1 db steps. Consists of a high Q coil capacity tuned. Dual frequency units have selector key for each frequency. Dial indicates equalization in decibel variance from 1000 cycles. Several equalizers may operate in parallel without affecting the other. For operation across a 500/600 ohm circuit. Dial in black anodized. Easily panel mounted.

## EQUALIZER FREQUENCY

30 cycles .....	SA-116
Dual, 50 and 100 cycles .....	SA-117
Dual 4000 and 6000 cycles .....	SA-118
Dual, 8000 and 10,000 cycles .....	SA-119
15,000 cycles .....	SA-120
Panel to mount four SA equalizers .....	SA-121

## FIXED AND VARIABLE EQUALIZERS



MODEL LE-1: Shown to left is a fixed equalizer. A parallel resonant circuit operating with either a 150 or 600 ohm line. Equalization is varied by means of self-contained resistors in 1 ohm steps up to 111 ohms. Inductance is tuned by 0.05 mfd and 0.025 capacitors, also self-contained.

SIZE: 2 1/2" x 2 1/2" x 3". Ideal for equalizing telephone lines or any circuit requiring correction.

FIXED EQUALIZER ..... LE-1



MODEL LE-2: Consists of the LE-1 equalizer with two variable controls, inserting the resistance in 1 ohm steps up to 111 ohms as required for full equalization. A double jack input is provided for direct parallel patching. Provision is also made for mounting a variable attenuator, sometimes desired in controlling line level. Panel Size: 19" x 3 1/2". Finish, medium gray.

VARIABLE EQUALIZER ..... LE-2

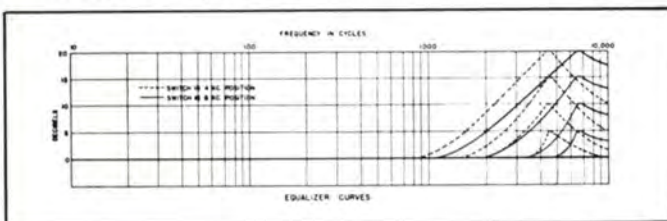

## SOUND EFFECTS EQUALIZERS



Ultimate in sound filters. Features wide frequency spectrum with overlapping cut-off frequencies, zero phase distortion, clickless steps of control, inductances toroidally wound and complete shielding for absence of hum pickup. Input level —70 to +28 dbm. Insertion loss, zero. Circuit constant, K. Available in two types: (a) low frequency cut-off, 10 positions of 70, 100, 150, 250, 500, 1000, 2000, 3000, 5000 and 7500 cycles, (b) high frequency cut-off, 10 positions of 300, 500, 1000, 2000, 3000, 5000, 6000, 7000, 8000 and 10,000 cycles. Provided with dial. Panel mounting. Size: 3 1/4" x 3 1/4" x 5" deep.

High frequency cut-off .....	FSE-1
Low frequency cut-off .....	FSE-2

# RACK CABINET RAK-1

A unit system type of rack cabinet of open frame construction, having removable sides along with various shields, joiner trims and end bells. Similar to those found in RCA systems. Rack mounting strips are movable from front to back in 6 steps of 1 1/4". Basic frame includes 2 panel mounting angles, 2 terminal board mounting angles, full size rear door and panel mounting screws. Other accessories are as follows:

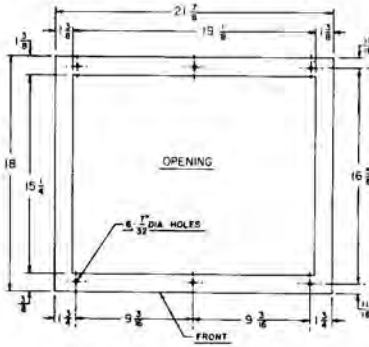

BASE DIMENSIONS, RAK-1 M 5706

**SPECIFICATIONS**

HEIGHT OVERALL: 84"  
 WIDTH (less SP-1 side panel): 22"  
 WIDTH OF SP-1 SIDE PANEL: 3"  
 DEPTH OVERALL: 21 1/2"  
 DOOR SWING: 22 1/2"  
 PANEL SPACE: 19" x 7 7/8"  
 MAXIMUM CLEARANCE BEHIND FRONT PANEL: 17"  
 PANEL MOUNTING: Standard rack multiples 12/24 mounting screws provided.  
 FINISH: Medium gloss gray.  
 NET WEIGHT RAK-1: 100 lbs.  
 SHIPPING WEIGHT: 195 lbs.

**ORDERING INFORMATION**

Basic Cabinet .....	RAK-1
Single Corner Trim .....	TRM-1
Double Corner Trim .....	TRM-2
Side Panel .....	SP-1
Shield .....	SH-1
Shield .....	SH-2
Terminal Board Mounting Bracket .....	BRK-1
Ventilating Fan .....	RAK-F-1



# RACK CABINET RAK-7

This new M-5527 is one of the finest rack cabinets in the economy field, and is suitable for all applications, including the mounting of tape recorders. Has solid sides, full size rear door with louvers at top and bottom. Finish is medium gray for both smart appearance and easy cleaning. — Standard cabinet is supplied with corner trim strips to cover panel mounting hardwood. M-5577 joiner trim is used when joining two cabinets together.

**SPECIFICATIONS**

DEPTH OVERALL: 19 1/2".  
 DOOR SWING: 20 1/2".  
 PANEL SPACE: 19" x 7 1/4".  
 CLEARANCE BEHIND PANEL: 17".  
 PANEL MOUNTING: Standard rack multiples 12/24 mounting screws provided.  
 FINISH: Medium gray.  
 NET WEIGHT: 120 lbs.  
 SHIPPING WEIGHT: 140 lbs.  
 HEIGHT OVERALL: 78".  
 WIDTH OVERALL: 23 1/2".

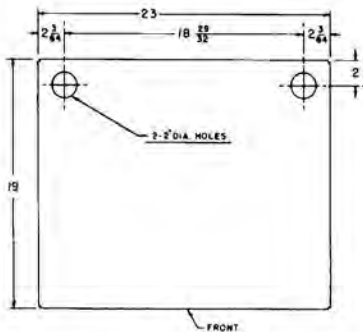

BASE DIMENSIONS, M5527 RACK

**ORDERING INFORMATION**

Rack Cabinet .....	RAK-7
Joiner Trim .....	M-5577

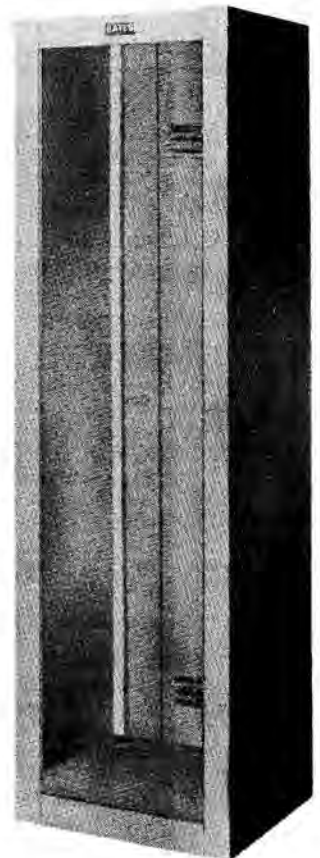



# PROOF OF PERFORMANCE EQUIPMENT

## CALIBRATED AUDIO OSCILLATOR

Measures audio frequencies between 30-30,000 cycles. No 0 reset or line calibration required. Self-contained power supply. Housed in attractive steel cabinet with carrying handle. Size: 13<sup>3</sup>/<sub>4</sub>" x 7<sup>1</sup>/<sub>4</sub>" x 9<sup>1</sup>/<sub>2</sub>".

### SPECIFICATIONS

- VOLTAGE OUTPUT: 10 volts into 500 ohms.
- WAVE FORM: RMS harmonics at 3 volts on 500 ohm load, less than 1% all frequencies 50-15,000 cps.
- RESPONSE: ±1 db or better 30-15,000 cycles.
- STABILITY: 1% or better.
- CALIBRATION: ±8% of scale reading.
- POWER: 115 volts, 50/60 cycles.

**Model 200 B & W Audio Oscillator**



## NOISE AND DISTORTION METER

For measurements of noise and distortion — both audio equipment and radio transmitters. Variable frequency selective filter provides single frequency suppression circuit of 30-15,000 cycles range. Size 13<sup>3</sup>/<sub>4</sub>" x 7<sup>1</sup>/<sub>4</sub>" x 9<sup>1</sup>/<sub>2</sub>" in attractive metal cabinet and beautifully styled.

### SPECIFICATIONS

- FREQUENCY RANGE: (a) Distortion meter 30-15,000 cycles measuring harmonics to 45,000 cycles.  
(b) Voltmeter and db meter 30-45,000 cycles.
- SENSITIVITY: (a) Noise and distortion, 0.3 volts.  
(b) Voltmeter, full scale readings, 0.3, 0.1, .03, .01 and .003 volts.
- CALIBRATION: For distortion ±0.5 db.  
For voltage measurements ±5% of full scale at 1000 cps.

**Model 400 B & W Distortion Meter**



## GAIN AND MEASURING SET

Ideal for use with above oscillator and distortion meter but may be used with any similar equipment. Consists of VU meter and associated switches to accommodate all usable ranges for measuring. Attenuation circuit includes a 10 step, 2 db per step, variable attenuator balanced ladder type, and three fixed plug-in pads. Pads are used for attenuation and impedance matching. Two pads have 40 db attenuation at 600/600 ohms and one has 20 db at 600/250 ohms, all balanced H. Additional pads of any loss or impedance obtainable on special order.

### SPECIFICATIONS

- INPUT IMPEDANCE: 600 ohms balanced.
- OUTPUT IMPEDANCE: 30 to 600 ohms balanced.
- OUTPUT LEVEL: Variable from -21 dbm to -36 dbm.
- RESPONSE: ±1/2 db 30-15,000 cycles.
- DISTORTION AND NOISE: Negligible.

**Model M-3625 Gain Measuring Set**



## M-3626 Rectifier/Pickup Coil

Used with AM transmitters in conjunction with Model 400 distortion meter, listed above. Picks up RF from tank circuit for measuring noise and distortion. Includes RF pickup coil, 15-foot section of coaxial cable, and germanium diode. Complete RF filtering guarantees pure audio output which is free from RF disturbances.

- FREQUENCY RANGE: 550-20,000 Kc.
- RESPONSE: ±1 db 30-15,000 cycles.
- OUTPUT IMPEDANCE: 600 ohms.
- OUTPUT LEVEL: +12 dbm.

## Complete Proof of Performance Package

Consists of type 200 Oscillator, Type 400 Noise and Distortion Meter, M-3625 Gain Measuring Set, and M-3626 Rectifier Unit with RF pickup coil and transmission line cable. Complete package provides all facilities for proof of performance of both audio frequency and AM radio transmitters. Provided with this package is a complete instruction book covering not only instructions for operating the equipment but suggested methods in making proof of performance measurements that are accurate and reliable.

**Model SA-131 Complete Proof of Performance Package**

# MICROPHONES



## ELECTRO-VOICE MODEL 654

Functional slim-trim styling; similar to Model 655C in design, but for slightly less exacting applications. A high-quality unit for remotes, man-on-the-street shows, and all-around studio use, 50-to-15,000 cps. response. Recessed switch selects 50 or 250 ohms output at -55 db. Tilttable head; TV gray finish; 18' cable. XL-3 connector; 5/8" -27 thread. Size: 10" by 1". Net wt. 15 1/2 oz.



## ELECTRO-VOICE MODEL 655C

The finest TV-BC microphone — widest range commercially available, 40 to 20,000 cps. Widely used as laboratory standard. Outstanding for single-mike applications. 50, 150, 250 ohms at -55 db. Adjustable clamp-on stand mount, 5/8" -27 thread, 1/2" adapter. TV gray finish. 20' cable, UA-3 connector. Size: 10 1/2" l., 1" dia. Net wt. 11 oz.



## SHURE MODEL 315

This rugged high fidelity multi-impedance microphone is recommended for fine quality, general-purpose uses. Frequency response, 50 to 12,000 cps. Equipped with a multi-impedance switch, furnishing a choice of 3 impedances: L-30-50 ohms, M-150-250 ohms, H-High, Standard 5/8" -27 thread. 6" high, 1-7/16" wide, 1-3/32" deep.



## ELECTRO-VOICE MODEL 664

A good medium-price cardioid, 40 to 15,000 cps response. 150-ohm and Hi-Z output at -55 db response. 150-ohm and Hi-Z output at -55 db. Chrome finish, cast case, 18' cable, MC-4 connector. 7-3/16" l., 1 7/8" dia. Net wt. 1 lb., 10 oz.



## ELECTRO-VOICE MODEL 636

Fine general purpose microphone with style and quality of the Model 655C. 60 to 15,000 cps response. Hi and Lo-Z at -55 db. Tilttable head; On-Off switch; chrome finish. 5/8" -27 thread. 18' cable, MC-4 connector. 10 1/4" l., 1 1/8" dia. Net wt. 15 oz.



## SHURE MODEL 556S

Specified by leading sound engineers and requested by famed celebrities — for those important events where the faithfulness of sound reproduction is most critical. Frequency response, 40 to 15,000 cps guaranteed to plus or minus 2 1/2 db. Equipped with a Multi-Impedance switch, furnishing a choice of 3 impedances — L-30-50 ohms, M-150-250 ohms, H-High. New improved self-adjusting "positive action" lifetime swivel permits tilting of the head through 45° forward and 90° backward. Equipped with Cannon XL-3-11 connector. 7 3/4" high, 2-3/16" wide, 3-1/16" deep.



## ELECTRO-VOICE MODEL 665

40 to 15,000 cps response. Recessed switch permits 50 or 250 ohms output at -55 db. Die cast case with nonreflecting gray finish. 5/8" -27 thread; 18' cable, XL-3 connector. Size: 7-3/16" l., 1 7/8" max. dia. Net wt. 1 lb. 10 oz.



## ELECTRO-VOICE MODEL 635

"Workhorse of the industry" for remote pickups, announcing, studio work. 40 to 15,000 cps. response. Switch selects 50 or 250 ohms output at -55 db. Tilttable head; chrome finish. 5/8" -27 thread. 18' cable, XL-3 connector. Size: 2" by 6 1/4". Net wt. 1 lb.



## ELECTRO-VOICE MODEL 647

Small, rugged, versatile. Response 60 to 10 kc, 150 ohms or Hi-Z. (specify when ordering) at -57 db output. TV gray finish. Neck cord, clip, 18' cable, built-in connector. Size: 5" by 1" dia. Uses Model 300 clamp (not included) for stand use. Net weight 4 oz.



## ALTEC MODEL 639

Broadcasters, recording engineers and public address users will find that the 639 is an invaluable microphone. The 639 is a cardioid microphone, with a frequency response of from 40 to 10,000 cycles. It is available in two models: 639A, with a 3-directional pattern, and the 639B, with a 6-directional pattern. Size: 7 1/2" high, 3-7/16" wide, 4-7/16" deep.

# ELECTRO-VOICE ACCESSORIES

## ELECTRO-VOICE ENCLOSURES AND SPEAKERS



### THE EMPIRE

Contemporary styling, functional design, and exceptional craftsmanship combine to provide an along-the-wall enclosure capable of superb musical reproduction. Accepts the speakers listed below. Available in mahogany, limed oak or walnut finish. Dimension 29<sup>5</sup>/<sub>8</sub>" high, 32" wide, 16" deep. Shpg. wt. 56 lbs.



### MODEL 15TRX

An excellent three-in-one speaker system for full-range reproduction. Response 30 to 19kc in Empire enclosure. Crossover points, 2kc and 3.5kc. 16 ohms impedance. Magnet wt. 5<sup>3</sup>/<sub>4</sub> lbs. Includes level control. 15<sup>1</sup>/<sub>8</sub>" dia., 9<sup>1</sup>/<sub>8</sub>" deep overall. Shpg. wt. 48 lbs.



### MODEL 15TRXB

Economy version of three-way Model 15TRX. Response 30 to 18kc in Empire. 16 ohms impedance. Magnet wt. 1<sup>1</sup>/<sub>8</sub> lbs. Includes level control 15<sup>1</sup>/<sub>8</sub>" dia., 7<sup>7</sup>/<sub>8</sub>" deep overall. Shpg. wt. 17 lbs.



### MODEL 848

Rugged, wide-range coaxial projector, for voice and musicasting. Coaxial performance in a weatherproof, blastproof fibreglass horn assembly. Response 200 to 10kc with wide-angle dispersion. 16 ohms impedance. 10<sup>1</sup>/<sub>2</sub>" wide, 20<sup>1</sup>/<sub>2</sub>" high, 20" deep. Shpg. wt. 17 lbs.



### MODEL 847

Compact and efficient, similar to Model 848 in operation but for low-level applications. Response 300 to 10kc. 16 ohms impedance. 11<sup>3</sup>/<sub>4</sub>" wide, 7<sup>3</sup>/<sub>4</sub>" high, 10" deep. Shpg. wt. 7 lbs.



### THE ARISTOCRAT

Unusually smooth reproduction from a modest size enclosure, when used with the speakers listed below. Specifically for room-corner placement. Crafted from the finest hardwood veneers; available in mahogany, limed oak or walnut finish. Dimension 29<sup>5</sup>/<sub>8</sub>" high, 19" wide, 16-5/16" deep. Shpg. wt. 44 lbs.



### MODEL SP12

Clean, sparkling reproduction is provided by this efficient 12" coaxial speaker. Response 30 to 13kc in Aristocrat enclosure. 16 ohms impedance. 3-lb. magnet. 12<sup>1</sup>/<sub>4</sub>" dia., 7<sup>1</sup>/<sub>2</sub>" deep overall. Shpg. wt. 25 lbs.



### THE BARONET

An excellent enclosure where space is limited. For room-corner placement on the floor or hang from the ceiling. Wide-range reproduction is assured using the Model SP88 listed below. Available in mahogany, limed oak or walnut finish. 22<sup>7</sup>/<sub>8</sub>" high, 14<sup>1</sup>/<sub>2</sub>" wide, 13<sup>3</sup>/<sub>4</sub>" deep. Shpg. wt. 20 lbs.



### MODEL SP88

The perfect complement for the Baronet enclosure. Smooth peak-free response from 35 to 13 kc. 16 ohms impedance. 1-lb. magnet, 8<sup>3</sup>/<sub>8</sub>" dia., 4<sup>3</sup>/<sub>8</sub>" deep overall. Shpg. wt. 9 lbs.

## MICROPHONE ACCESSORIES

### MODEL 345 SHOCK MOUNT

Dual-type, prevents reproduction of external shocks, vibrations. Easily attached, removed. Chrome finish. 3/8"-27 thread. Size 3/8" by 1/2" dia. Net wt. 10 oz.



### MODEL 346 SHOCK MOUNT

Similar to Model 345 but specifically for use with Model 666, other 11-oz microphones. TV gray finish.



### MODEL 366 BOOM SHOCK MOUNT

Extremely light suspension shock mount. Designed for use with 666, 667, 655C, other 1" diameter microphones. No tools required for installation. Pictail cable connection (UA-3 connectors) forms cable shock-isolation loop.



### MODEL 300 MICROPHONE CLAMP

Lightweight adapter fits any 1" dia. mike, provides positive stand mount; finger-operated non-slip clamp. 3/8"-27 thread, 1/2" adapter.



### MODEL 524 WIND SCREEN

Minimizes wind effects, boom or outdoor use. Made of Acoustiform rubber. For use with Models 666, 667. Net wt. 2 oz.



### MODEL 335 BLAST FILTER

Acoustically treated to stop wind, breath blasts without affecting frequency response. For Models 630, 635, 605. Chrome finish.



## ELECTRO-VOICE DESK STANDS

### MODEL 418

Heavy die cast base, TV gray finish. For use with small-stud mikes such as Models 611, 623, 630, 635 and 636.



### MODEL 418-S

Stand with on-off switch.

### MODEL 419

Similar to Model 418 but for use with Models 654, 664, and 665.



### MODEL 419-S

Stand with on-off switch.

### MODEL 420

Heavy cast iron base, TV gray finish. With simple, positive finger-operated clamp. Mounts Models 666, 667, 655C, 646, other 1" dia. mikes. Net wt. 3 lbs.



### MODEL 423-A

Sturdy, smartly styled. Round die cast base. 5/8" dia., rubber base buttons. Chrome finish. Specify 3" or 5" stem riser. 3/8"-27 thread. Net wt. 1 lb.



### MODEL 428 TOUCH-TO-TALK STAND

Lever-type switch for relay operation or mike on-off. SPDT or DPDT switch (specify when ordering). Closes, opens instantly or locks in "talk" position. Chrome finish, gray plastic switch lever. Size: 7" by 5/8" base dia. Net wt. 1<sup>3</sup>/<sub>4</sub> lbs.



# ACCESSORIES

## FLOOR STANDS



A floor stand with a big heavy base, listed to left above. Weight 24 lbs, and base 17" across. Adjustable to 66". Full chrome with gray base.  $\frac{5}{8}$ " x 27 thread. Non-slipping clutch. Fits all microphones listed in this catalog.

Microphone Floor Stand ..... MS-25

Here is a good medium-priced floor stand with a 10" diameter base, chrome pipe and gray base. Adjustable to 64" with  $\frac{5}{8}$ " x 27 thread and non-slipping clutch. Weight 9 lbs.

Microphone Floor Stand .... MS-10C

## BOOM BRACKET

A boom bracket to attach to any existing floor stand with  $\frac{5}{8}$ " x 27 thread. 32" long, chrome plated. Counter balance adjustable for various microphones.

Boom Bracket ..... BB-1

## BOOM STANDS



Boom length 62" (more extension addable). Adjustable vertical extension 48"-72". Base diameter 17". Tubular sections super-chrome plated. Modernistic base finished in chrome and gun metal shrivel. "Snap On" hangers furnished to hold mike cable to boom section. Ship. wt. 33 lbs.

Boom Stand without casters ..... BS-36

Boom Stand with silent casters ..... BS-36W

## DEMOUNTABLE FLOOR STAND



A completely demountable floor stand for easy, light weight portability, yet unusually strong and sturdy. Adjusts from 26-64". Finish, Chrome.  $\frac{5}{8}$ " x 27 thread. Rubber cushioned feet. Weight, 4 lbs. Can be collapsed to length of 22 $\frac{1}{2}$ ".  
Demountable Stand ... CS-33

## DESK STAND



Adjustable 8" to 13" chrome stem and substantial cast base with felt feet.  $\frac{5}{8}$ " x 27 thread.  
Desk Stand ... DS-7

DS-7

## BANQUET STAND

Adjustable 18" to 32", chrome stem and 8" diameter base.  $\frac{5}{8}$ " x 27 thread. Full grip velvet action silent adjustment.

Banquet Stand ..... TS-6



TS-6

## HEAD PHONES



BRUSH DUAL CRYSTAL UNIT as illustrated. Smartly styled, unusually sensitive and dependable. For all professional service.

Dual Head Set ..... BA-200

BRUSH SINGLE HEAD SET with head band. Otherwise same as dual unit above.

Single Head Set ..... BA-201

TRIM DUAL HEAD SET, feather weight model, long recognized as an industry leader. Impedance 24,000 ohms.

Trim dual head set ..... 107

TRIM S HEAD SET, particularly designed for broadcast use. Response substantially flat through all essential frequencies. Shell and cap molded plastic. Alnico V magnet. Floating diaphragm. Supplied with cushions. Impedance 600 ohms.

Trim S head set ..... 35-3



Sessions



Seth Thomas

## STUDIO CLOCKS

SESSIONS clock has large sweep second hand and bold black numerals on a white dial. Size: 13 $\frac{1}{2}$ " diameter. Very accurate and time set is at bottom front. Finish gray, non-glaring, 115 volts, 60 cycles.

Sessions Electric Clock ..... RB-89

SETH THOMAS. Thin design, bright chrome finish, convex glass with bold black lettering and easy to see second hand. Sets from front. This clock 15" in diameter with 12 $\frac{1}{2}$ " dial and only 1 $\frac{3}{4}$ " deep. 115 volts, 60 cycles.

Seth Thomas Electric Clock ..... 602

## RECORD-TAPE SERVICE CABINET

For the handling of records and transcriptions at the point of usage. To the top front are four compartments, 8 $\frac{1}{2}$ " high, 4 $\frac{1}{4}$ " wide and 7 $\frac{1}{2}$ " deep. At the bottom are two more compartments, 8 $\frac{1}{2}$ " high, 8 $\frac{1}{2}$ " wide and 7 $\frac{1}{2}$ " deep. At the left is a compartment, 17" high, 5" wide and 14" deep. This construction of compartments will handle 7", 10", 12" and 16" discs plus all size tape reels. At the top back is the discharge section for all size discs and tapes after usage.



Record-Tape Service Cabinet ..... M-5611

## STUDIO WARNING LIGHTS



An attractive and modern design light available in many different wordings. Lettering is on plexiglass and illumination is edge-wise, illuminating letters only. Size: 18" wide, 6 $\frac{1}{2}$ " from top of glass to base of lamp enclosure, 3" deep.

LETTERING	CAT. NO.
Studio A	AM-1
Studio B	AM-2
Control Room	AM-3
On Air	AM-4
Special Lettering*	AM-5

\* 12 or less letters or numbers



Non-shatterable 180° plastic prism lens, in red (standard), green, blue, amber and crystal. Panel may be flashed opal or translucent Lucite. Lettering of more than 16 characters may not be legible at required distances. Two rows of figures may be used;  $\frac{3}{4}$ " maximum letter height. Frames are cast aluminum with hammer-tone finish in silver, gray and bronze. End caps are zinc, finished in decorative or satin chrome.

On-Air Warning Light ..... QT-7

# ACCESSORY EQUIPMENT

## GE 12" LOUDSPEAKER



A 45-13,000 cycle, 12" loudspeaker with 9-ounce Alnico V magnet, 8 ohm voice coil to handle 25 watts program material. For fullest fruition suggest use with A1-406 enclosure listed below. Diameter 12 7/32". Highly recommended for top-flight monitoring and audition.

GE 12" Loudspeaker ..... 1203A

## GE 6" SPEAKER CABINET



Features "distributed part" acoustical design for smooth, full low frequency response. For corner or straight wall placement. 31 1/4" high, 25 7/8" wide and 18 1/4" deep. Available in blonde, mahogany and unfinished. A beautiful cabinet in both performance and appearance, and modestly priced.

GE speaker cabinet, blonde ..... A1-406B  
 GE speaker cabinet, mahogany ..... A1-406M  
 GE speaker cabinet, unfinished ..... A1-406U

## GE 8" SPEAKER ENCLOSURE

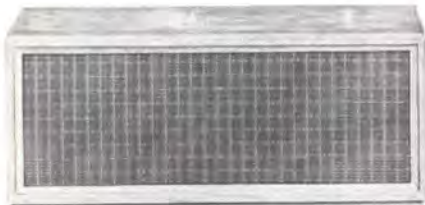

Only 10" high, this beautiful enclosure for 8" speakers may be mounted horizontally near the ceiling, on a shelf or vertically. Has "distributed part" acoustic design. A fine enclosure for audience or reception room. Size: 26" wide, 10" high and 11" deep.

GE enclosure, blonde ..... A1-412  
 GE enclosure, mahogany ..... A1-411  
 GE enclosure, unfinished ..... A1-414

## WALL BAFFLES



Flat Mount

Corner Mount

For 12" loudspeaker and available in blonde or mahogany. Ideal for studio, reception room and general sound distribution.

Flat wall baffle (blonde) ..... DWB-12  
 Flat wall baffle (mahogany) ..... DWM-12  
 Corner wall baffle (blonde) ..... C12A-B  
 Corner wall baffle (mahogany) ..... C12A-M

## CEILING BAFFLE

Spun aluminum, satin finish for 8" speaker provides 360° coverage. Mounts flush with ceiling. Ceiling baffle ..... A18-A



## PRESTO 6N DISC RECORDER



The "Mr. Recorder" of the disc recording field. Illustrated in portable case but floor cabinet available for permanent use. Designed specifically for broadcasting station and recording laboratory. When used with the A93 amplifier, listed below, a wide variety of recording curves are possible and will meet all currently popular standards. Records at 33-1/3, 45, or 78 RPM. Feed screw supplied is 112 lines per inch inside to out. Feed screws of 96, 104, 120, or 136, either inside to out or vice versa, are available along with microgroove pictures of 244, 256 and 288. For 115 volts, 60 cycles, Cutting head impedance, choice of 15 or 500 ohms. Playback pickup 500 ohms.

Recorder, chassis only ..... 6N  
 Recorder, in portable case (illustrated) ..... 6NP  
 Recorder, in floor cabinet ..... 6NC  
 Microgroove feed screw, 244 lines ..... 32M

## A93 RECORDING AMPLIFIER



Suggested for use with 6N recorder listed above. Provides 3 curves of: (1) flat, (2) phono recording, and (3) NARTB. Radius switch incorporated permits operator to compensate for loss of high frequencies at center of disc. Includes VU meter, range control and master gain. Power, 30 watts.

Recording amplifier ..... A93

## PRESTO 1D CUTTING HEAD

Recognized as the finest in the disc recording field. Very low distortion and flat response from 50-10,000 cycles. Available in 16 or 500 ohms. Illustrated on Presto recorders listed above.

Recording head, 16 ohms ..... ID-16  
 Recording head, 500 ohms ..... ID-500

## RECORDING STYLUS

Professional type, disc tested, for best possible recordings. State whether long or short shank when ordering.

87° sapphire, dural shank ..... GR14-87  
 70° sapphire, dural shank ..... GR14-70  
 Microgroove sapphire, dural shank ..... GR-20

## SPEAKER MATCHING TRANSFORMERS

Primary adjustable to 500, 1000, 1500 or 2000 ohms. Secondary as stated below. Power handling 10 watts for ZY-2002 and ZY-4004 and 16 watts for ZY-2003.

Matching transformer, Sec. 8 ohms ..... ZY-2002  
 Matching transformer, Sec. 4 ohms ..... ZY-4004  
 Matching transformer, Sec. 8 ohms ..... ZY-2003

## JENSEN PM SPEAKERS

This popular speaker is very modest in price and available in 8", 10" and 12" sizes. Voice coil 6-8 ohms. Power rating 8 watts on 8" and 10" models and 9 watts on 12" model. For general studio work with wall baffles and GE speaker enclosures, these models are excellent.

8" Jensen speaker ..... P8S  
 10" Jensen speaker ..... P10T  
 12" Jensen speaker ..... P12T



**BOGEN-PRESTO  
 TT4 THREE-  
 SPEED 12"  
 TURNTABLE**

A new design, the TT4 plays all three speeds to perfection. Wow, flutter, and ramble are virtually non-existent. Constant speed hysteresis motor rotates balanced cast aluminum turntable. Interchangeable idler wheels disengage in "Off" to prevent flats. Exclusive "radial ridge" mat permits wide hole 45 rpm discs to seat properly without raising spindle. Built-in snap-action spindle retracts for new 7" 33-1/3 rpm discs.

Bogen-Presto T68AH three speed 16" turntable



**BOGEN-PRESTO  
 T68AH THREE  
 SPEED 16"  
 TURNTABLE**

The finest rim-drive 16" turntable today. Precise machinery insures trouble-free operation and practically non-existent wow, flutter, or hum. Aluminum turntables is padded with specially formulated rubber that cushions discs and affords perfect traction. Large positive-action speed selector has five positions (45, off, 33-1/3, off, 78) with separate idler wheel for each speed. Interchangeable idler wheels disengage when in the "Off" position and are easily replaced. Complete with 45 rpm adapter.

Three-speed 16" turntable ..... T68AH

# ACCESSORY EQUIPMENT

## BULK TAPE ERASER



Bulk tape demagnetizer developing high intensity magnetic field. Erases recorded signals and noise completely and restores tape to like new condition. Handles 5", 7" and 10 1/2" reels. Adapter hub available (optional accessory) for 10 1/2" reels. 117 volts, 50/60 cycles.

Tape eraser ..... HD-11



## TAPE SPLICER

Cutter cartridges house 3 long life blades. Two operating positions, miter cut and trimming cut selected by knob. With clear plastic dust cover.

Gibson standard splicer ..... TS4H

## INDUSTRIAL TAPE SPLICER



For computer, TV and industrial tapes up to 1" wide. Long life, easily replaceable blades. Precise blade centering adjustment. Heavy cast base.

SIZE	Cat. No.
For 1/2" tapes	TS-250
For 3/4" tapes	TS-500
For 5/8" tapes	TS-625
For 3/4" tapes	TS-750
For 1" tapes	TS-1000

## TAPE CABINETS



Holds 42 reel boxes of 7" tape reels. 13 1/8" wide, 12 5/8" high, 8 5/8" deep. Has six compartments. May be stacked as desired. .... TR-742

Holds 21 reel boxes of 10 1/2" tape reels. 13 1/8" wide, 12 5/8" high, 12" deep. Has three compartments. May be stacked as desired. .... TR-1021

## SECTIONAL DISC CABINETS



All metal supplied with 90 heavy red wallet pockets, one for each record, two sets gummed numbers, 270 printed cataloging cards for 3-way cross index and steel card file.

Record Size	Width	Height	Depth	Pocket Cap.	Cat. No.
7"	13 1/8"	9"	9"	90	A-7
10"	13 1/8"	12 3/8"	12"	90	B-10
12"	13 1/8"	15 3/8"	14"	90	C-12
16"	13 1/8"	20 3/8"	20"	90	D-16



## FILM CABINET

Closed top, base and sides. Open front and back. Equipped with separator racks adjustable to 1" centers. Gray enamel finish. Size: 30" wide, 75" high, 15" deep. Capacity: 44-400' reels, 20-600/800' reels, 1200/1600' reels. Size computed with reel cans.

Film Cabinet .... F50-6120

## FILM REELMOBILE

Accommodates up to 27-400' reels, 25-600/800' reels and 25-1200/1600' reels. 3" moulded cushion-tread swivel casters, two with brakes, made of steel, finish gray. Film separator racks adjustable vertically on 1" centers. Size: 41 1/2" high, 15" deep and 36" wide.

Film Reelmobile ..... RM-77

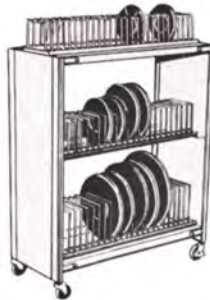

## DIS CABINET

Protect those expensive and fragile 12" LP's as they should be. Holds 540 12" LP's with a heavy red wallet for each. Includes two sets of numbers, 1620 printed catalog cards and card file. Size: 60" high, 29" wide and 14" deep. Double door with lock and key.

Disc Storage Cabinet ..... C-540

## CONTROL ROOM CHAIR



Selected by Gates for comfort and utility in control room service. Smooth running, quiet caster, 180° swivel, adjustable height, form fitting back contour. Covering DuPont fabric. A strong serviceable chair to prevent fatigue.

Control Room Chair ..... 255

## STYLUS FORCE GAUGE



An inexpensive yet much needed item wherever transcriptions are used. Measures pressure in grams of stylus on record.

Stylus gauge ..... 301

## STUDIO AND MICROPHONE CABLE

### Studio Cable



Shielded 2-conductor No. 20 stranded, cloth and heavy cotton fabric with tinned copper shield overall. Finest quality for studio audio wiring. Packaged in 250', 500' and 1000' lengths ..... SH-20

Shielded 2-conductor No. 22 solid enameled, cotton wrap and cotton braid waxed. Tinned copper shield. Has 22 AWG tinned solid copper wire under shield and tubed chrome vinyl plastic jacket. Small size 0.185" diameter. Packaged 100', 500', 1000' spools ..... 8440

A very small 2-conductor shielded cable frequently used in rack wiring, OD. 125". Has 2-conductor 16/36 stranded plastic insulation of each conductor with tinned copper shield overall. Packaged 250', 500' and 1000' spools ..... 1261

Shielded 2-conductor No. 18 stranded for power cabling. Has rubber insulation and overall rubber jacket. OD 9.295". Available in 50' and 100' spools. .... 8428

### Microphone Cable

Rubber jacketed shielded highly flexible 2-conductor microphone cable of high commercial quality. Available any length as ordered. Per foot ..... MIC-100

Single conductor shielded rubber jacketed microphone cable ..... 8410

# AMPEX PROFESSIONAL TAPE RECORDER

Series 300



to serve as a temporary playback head, while the others are still recording. This permits recording sound-on-sound or adding a missing soloist to previously recorded music, all in perfect synchronization. It is SEL-SYNC on an 8-channel Ampex Series 300 that has enabled Les Paul and Mary Ford to make their world-famous recordings.

**MODEL 300-2M:** This is actually a two-channel machine especially designed to produce a four-track, half-inch, intermediate master. The master is used on the Ampex 3300 High-Speed Duplicator to produce 1/4" 4-track stereo tapes for commercial release.

**SINGLE CHANNEL VERSION:** Available as a single channel recorder in console, or unmounted for rack or portable installation, the Model 300 is unexcelled as a general purpose recorder. They are widely used in radio and professional recording studios throughout the world.

## TAPE TRANSPORT



The uncompromising quality characteristics, both electronic and mechanical, inherent in the Ampex Series 300 result in superiority of performance and exceptionally long, trouble-free operation. Maintenance requirements, servicing needs, and out-of-service time are negligible or non-existent. For mechanical stability . . . rugged, precision manufacture . . . reserve operating capacities . . . and wide range recording abilities . . . the Ampex 300 is the recorder of preference for heavy, continuous service.

**STEREOPHONIC RECORDING:** The commercial recording industry has adopted three or four channels as the optimum in master stereophonic recording. Ampex Multi-Channel models are finding increasing use among professionals who wish to eliminate any possibility of the "hole-in-the-middle" effect. The three or four channel master is transferred to a two channel version for commercial release by mixing the middle channel or channels with the two outer channels.

**TWO TO EIGHT CHANNEL Ampex Series 300 Recorders** are available. Depending upon the number of channels involved, they can be ordered as consoles or unmounted for rack or portable installation. An Ampex 300 Recorder, purchased as a single channel version, may later be converted up to three channels with available kits. SEL-SYNC\*. An exclusive Ampex feature that is optional on any Multi-Channel recorder, SEL-SYNC is a switching system that permits converting any of the recording heads

Three precision, heavy duty motors handle reels up to 14 inches in diameter, tapes up to 1 inch in width (the Ampex Series 300 are the only recorders that will accommodate more than one-half inch tape). Flutter and wow have been virtually eliminated due to rigid unit assembly, carefully designed precision capstan drive, massive flywheel and longer tape path. Tape skewing is non-existent; starts and stops are instantaneous.

**CONTROLS:** Record, Start and Stop buttons are recessed so that they will not be accidentally pressed; all can be remote controlled. A Fast Start/Slow Start switch allows the capstan motor to remain in "on" or "standby" position.

**LONG-LIFE PRECISION HEADS:** The rugged construction and carefully controlled fabrication assures uniform characteristics during their exceptionally long life. Ampex magnetic heads tested after 15,000 to 18,000 operating hours still meet published specifications in virtually every instance.

**PRECISION ALIGNMENT:** Ampex Multi-Channel recorders add an additional element of quality: the precision manufacture and alignment of the Multi-Channel heads. They are so perfect, so uniform, that tapes recorded on an Ampex Multi-Channel can be played with perfect results on any other Ampex Multi-Channel anywhere in the world without phase shift between channels.

## AMPEX SERIES 300 PROFESSIONAL TAPE RECORDER

### WIDE RANGE RECORDING

**NEGLIGIBLE FLUTTER AND WOW:** The requirements for the professional recording market—wherein the ultimate consumer may get up to the sixth generation recording—make it imperative that the master tape be free from flutter and wow. This can only be achieved through the Ampex 300 Recorders whose flutter and wow characteristics are so low as to be practically eliminated. Even when pyramided through several generations, flutter and wow are still far too insignificant to be audible.

**FREQUENCY RESPONSE:** Combining an essentially flat response from 30 to 15,000 cycles with a high signal-to-noise ratio, and the almost complete freedom from flutter and wow, results in master recordings of unsurpassed quality. And—Ampex Series 300 Recorders continue to deliver this ultimate in performance even after many years of continuous use.

**THREE EQUALIZATIONS:** NAB equalization is supplied on single channel models unless otherwise ordered. Multi-Channel versions are supplied with exclusive AME (Ampex Master Equalization) and NAB as standard equipment; CCIR equalization can also be ordered. The AME curve represents a considerable advance in master recording and gives an effective 7 db increase in signal-to-noise ratio over the 2,000 to 6,000 cycle range . . . thus reducing "subjective" tape hiss found in this frequency range. This lower noise level is particularly advantageous in producing the new 4-track stereo tapes.

**MONITORING:** An AB switch allows comparison of input and tape output by means of (1) a VU meter, (2) headphones plugged into the front panel, or by (3) a line connected to the studio monitor circuit.

### SPECIFICATIONS

**FREQUENCY RESPONSE:** 15 ips = ±2 db 30 — 15,000 cps.  
7½ ips = ±2 db 40 — 10,000 cps.  
              ±4 db 30 — 15,000 cps.

**SIGNAL-TO-NOISE RATIO:** Peak record level to unweighted noise (db) 7½ or 15 ips. 60 db = Full Track, 55 db = Multi-track. Peak record level defined as highest level at which overall (input to output) total rms harmonic distortion does not exceed 3% when measured on 400 cycle tone. Noise is measured when erasing signal of peak recording level in absence of new signal. Thus, bias and erase noise are included as well as playback amplifier noise. All frequencies measured from 50-15,000 cycles.

**FLUTTER AND WOW:** 15 ips — less than 0.2% rms, 7½ ips — less than 1.2% rms. All frequencies measured from 0-300 cycles.

**PHASING:** All channels in phase when simultaneously recording and playing back a mid-frequency range test signal.

**CROSS TALK REJECTION:** 50 db on standard Multi-Channel models 60 db on 300-2M Special Master.

**STARTING TIME:** To full speed:

1/10 sec. for 1/8" tape,  
1/2 sec. for 1/2" tape

**STOPPING TIME:** 15 ips = —2" of tape past heads  
7½ ips = —1" of tape past heads

**TIMING ACCURACY:** 0.2% or ±3.6 sec. for 30 min. recording

**REWIND TIME:** 1 min. approx. for full 10½" reel (2400 ft.)

**CONTROLS:** Stop, Start, Record — push button, relay operated; remote control optional.

Normal Play, Fast Forward, Rewind — on selector switch which may be changed from one mode to another without stopping in between. Multi-Channel recorders have separate button on electronics panel that energizes record relay for that channel only. Relay drops out when Stop button is depressed. Operation of Record button on tape transport actuates record relays on all channels.

**MONITORING:** Independent record and playback systems allow tape to be monitored while recording.

**EQUALIZATION:** Single channel: speed selector switch selects proper NAB equalization for the given speed. Multi-Channel: switch on electronics panel selects 7.5 NAB, 15 NAB or 15 AME. CCIR equalization available on special order.

**INPUTS:** Single channel: balanced or unbalanced +4VU bridging inputs.

**INPUTS:** Multi-Channel: switch selects low impedance microphone, balanced or unbalanced +4VU bridging inputs.

**OUTPUTS:** Single channel: 600 ohm, +4VU, (+4 DBM) balanced or unbalanced.

**OUTPUTS:** Multi-Channel: 600 ohm, +8VU, (+8 DBM) or +4VU, (+4DBM) by restrapping, balanced or unbalanced.

**POWER INPUT REQUIRED:** 117 volts, 60 cycles (also available for 50 cycles). Single Channel recorders require 3 amperes, add 0.5 amperes for each additional channel.

### ORDERING INFORMATION

**STANDARD MODELS:** All with in-line heads; dual speed 7½ and 15 ips.

Single channel, full track, ¼" tape width ..... Model 300

Two channel, ¼" tape width ..... Model 300-2

Two channel, ½" tape width (special heads for four track masters) ..... Model 300-2M

Three and four channel, ½" tape width, with or without SEL-SYNC ..... Model 300-3 and 4

**SPECIAL MODELS:** 300-6 and 8—six and eight channel, 1" tape width, with or without SEL-SYNC. Special head configurations and operating speeds from 1⅞ to 30 ips are also available.

**MOUNTING:** All models up to three channels available mounted in consoles, or unmounted for rack or portable installation. Four channel to eight channel available in console and rack combination, or uncased.



# AMPEX PROFESSIONAL TAPE RECORDERS

Series 351

The Ampex Model 351 sets the highest standard in professional tape recording performance. Completely new inside, it combines the latest in circuits and electronics with Ampex superior tape handling characteristics.

## SPECIFICATIONS

**TAPE SPEEDS:** 7½ and 15 ips. or 3¾ and 7½ ips.

**FREQUENCY RESPONSE:** All versions: 15 ips. ±2 db db 30 to 15,000 cps.

**FREQUENCY RESPONSE:** 7½ ips. ±4 db 30 to 15,000 cps. (±2 db 40 to 10,000 cps.)  
3¾ ips. ±2 db 50 to 7,500 cps.

### SIGNAL-TO-NOISE RATIO:

Speed	Max. Record Level to Unweighted Noise	Peak Record Level to Unweighted Noise
15"	Full track 70 db Half track 65 db 2 Channel stereo 65 db	Full track 60 db Half track 55 db 2 Channel stereo 55 db
7½"	Full track 70 db Half track 65 db 2 Channel stereo 65 db	Full track 60 db Half track 55 db 2 Channel stereo 55 db
3¾"	60 db	50 db

### FLUTTER AND WOW:

15 ips.	Well below 0.15% RMS.
7½ ips.	Well below 0.2% RMS.
3¾ ips.	Well below 0.25% RMS.

### PLAYING TIMES:

With NAB Speed	Half Track	Full Track
10½" reels 15 ips.	64 min.	32 min.
(2400 feet of tape) 7½ ips.	2 hrs. 8 min.	64 min.
3¾ ips.	4 hrs. 16 min.	2 hrs. 8 min.

**STARTING TIME:** Instantaneous (tape accelerates to full speed in less than 1/10 second).

**STOPPING TIME:** At 15 ips. speed, tape moves less than two inches after pressing "Stop" button.

**PLAYBACK TIMING ACCURACY:** ±0.2% (±3.6 seconds in a thirty minute recording).



Unmounted (Rack), One and Two Channels

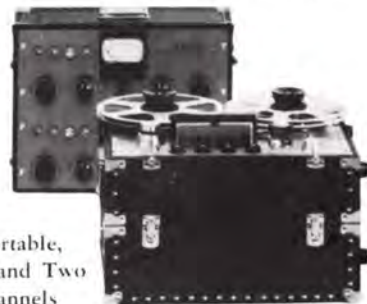

Portable, One and Two Channels



Console, One Channel Only.

**REWIND TIME:** Approximately one minute for 2400-foot NAB reel; 30 seconds for 1200-foot EIA reel. Rewind times for this base tapes proportionately longer.

**CONTROLS:** Tape motion controlled by four pushbuttons; Start, Stop, Fast Forward and Rewind. Separate Record button energizes record circuits, which drop out when machine is stopped. Individual Record button control for each channel in 2 Channel stereo machines. Motor speed and electronic equalization for various tape speeds are controlled by separate switches. Reel Size Switch provides proper tape tensions for NAB 10½" reels or EIA 5" and 7" reels.

**RECORD INPUT:** A switch allows recorder to accommodate either microphone level low impedance input or to bridge a 600 ohm line, balanced or unbalanced. Minimum input signal for recommended record level is -10 dbm balanced bridge, or -13 dbm unbalanced bridge. Levels as low as 150 microvolts on the microphone input will produce the recommended record level.

**PLAYBACK:** Plus 8 VU output into 600 ohms, balanced or unbalanced. Will feed a high input impedance amplifier directly with approximately two volts. Can be connected for +4 VU by restrapping.

**AMPEX PROFESSIONAL TAPE RECORDERS**

**MODEL 351 SPECIFICATIONS (Con't)**

**AMPLIFIERS:** Separate record and playback amplifiers are used. Amplifier distortion at any operating level is negligible compared to tape distortion, even using new high-output tapes.

**PLUG-IN HEAD HOUSING:** Erase, record and playback heads are contained in a single plug-in head housing.

**MONITORING:** Independent record and playback systems allow tape to be monitored while recording. A phone jack is provided to monitor either the record input signal before or during recording, or the output signal from the playback head while recording or during playback. An A-B switch is incorporated in order that direct comparison can be made between the original program and the recorded program. The same switch transfers a 4-inch VU meter for level comparison and monitoring. The VU meter is also used to read bias and erase current.

**POWER REQUIREMENT:** Either half or full-track machines require 2.0 amperes at 117 volts AC., 2 Channel stereo requires 2.5 amperes. Machines are available for either 50 or 60 cycle operation.

**RACK SPACE:** Standard 19 inch wide panel with commercial notching.  
 Tape Transport, 15<sup>3</sup>/<sub>4</sub> inches of rack space, weight ..... 58 lbs.  
 Electronic Assembly, 7 inches of rack space, weight ..... 18 lbs.  
 (Two required for 2 Channel stereo.)

**CONSOLE DIMENSIONS:** 48 inches high x 24<sup>1</sup>/<sub>2</sub> inches wide x 28<sup>1</sup>/<sub>2</sub> inches deep;  
 weight ..... 168 lbs.  
 (crated 260 lbs.)

**ORDERING INFORMATION**

- Mounting Style — Console, rack-mount or two case portable for Full or Half Track; rack, or portable for 2 Channel stereo ..... Model 351**
- Tape Speed — 7<sup>1</sup>/<sub>2</sub> and 15 ips. or 3<sup>3</sup>/<sub>4</sub> and 7<sup>1</sup>/<sub>2</sub> ips.**
- Track Configuration — Full track, or half track, or 2 track stereo.**
- Power Line Frequency — 60 or 50 cps. (117 V. only).**

**AMPEX 601 PORTABLE TAPE RECORDER**



*This famous Ampex Portable fits your recording needs exactly.*

- LOW IMPEDANCE OUTPUT:** 600 ohms, 1.23 volts. Balanced or unbalanced (from tapes recorded at program level).
- LOW IMPEDANCE INPUT:** Accommodates high or low impedance microphone. Low impedance microphone secured by accessory plug-in transformer.
- INSTANTANEOUS STARTING:** Accelerates to full play mode in less than one-fifth of a second.
- SUPERB FIDELITY:** Frequency response, 30 to 15,000 cps., at 7<sup>1</sup>/<sub>2</sub> in/sec. Down no more than 4 db at 15,000 ±2 db from 40 to 10,000. Signal-to-noise ratio over 55 db. Flutter and wow — Below 0.17%. Separate erase, record and playback heads.
- PRECISE TIMING:** Synchronous motor drive. Timing accuracy within 3.6 seconds in its 30 minutes playback.
- EASIEST OPERATION:** Simple one hand "wrap around" threading. Large scale meter for accurate program levels. Can be monitored during either record or playback. Suitable for rack mounting.
- DEPENDABLE SERVICE:** Vital parts have been tested an equivalent of more than 10 years of normal broadcasting usage. "Lift-out" accessibility for maintenance.

**ORDERING INFORMATION**

**Full or half-track. Portable case or unmounted chassis. 60 cycle operation (50 cycles available on special order). With or without, accessory low impedance input transformer, 17331-1 ..... Model 601**

**AMPEX 620 AMPLIFIER-SPEAKER**

*Designed to match the Ampex 601*



- FIDELITY:** Speaker and amplifier in combination have flat acoustic response from 65 to 10,000 cycles with additional useful range above and below.
- POWER:** Amplifier output is 10 watts with less than 1% harmonic distortion. Speaker can use full power if necessary, giving ample volume even for a medium size auditorium.
- VERSATILITY:** The Ampex 620 can amplify from any sound source. It may be used as an amplifier-speaker or as an amplifier only, since an external speaker jack bypasses the internal speaker and its reciprocal network.

**ORDERING INFORMATION**

**Ampex Amplifier-Speaker ..... Model 620**

# TELECTRO PROFESSIONAL TAPE RECORDERS

## Model 938



Model 938-C



Model 938-R



Model 938-P

One of the finest commercial tape records and playback units manufactured today. Commercial equivalent to the much used Government Model AN/TNH-2B. Available in console, rack and portable two-case models.

Tape transport mechanism is a masterpiece of precision. Partial features include: (1) hysteresis synchronous motor, (2) dual torque motors for supply and take up reels, (3) adjustable take up torque, (4) self-aligning solenoid operated brakes, (5) heavy fly-wheel for low flutter, (6) automatic shut off switch, (7) push-button operation with easy remote control operation, (8) editing knobs, and (9) will rewind a full 10 1/2" reel in one minute.

### MECHANICAL AND ELECTRICAL SPECIFICATIONS

- STARTING TIME: Less than 0.1 second.
- STOPPING TIME: At 15 ips tape moves less than 2 inches after stop switch is operated.
- PLAYBACK TIME: 1 hour at 7 1/2 ips with standard 10 1/2 inch NARTB reel for half-track recording; 2 hours using both tracks; up to 3 hours using long play tape.
- PLAYBACK TIME ACCURACY: Better than 0.2%.
- REWIND TIME: Less than 1 minute.
- FAST WIND TIME: Less than 1 minute.
- PLUG-IN HEAD ASSEMBLY: Dual track heads are standard. Soundhead assembly contains erase, playback and record heads. Available with single track heads.
- MOUNTING AND INSTALLATION: Horizontal or vertical. Designed for either rack or console installation. Also available in handsomely designed carrying case.
- WOW AND FLUTTER: Less than 0.15% rms at 15 ips. Less than 0.2% rms at 7 1/2 ips.
- POWER SOURCE: 115 volts, 60 cps.
- POWER CONSUMPTION: 230 watts.
- FREQUENCY RESPONSE: at 15 ips ..... 30 to 15,000 ± 2 db.  
at 7 1/2 ips ..... 30 to 15,000 ± 4 db.  
at 7 1/2 ips ..... 30 to 10,000 ± 2 db.
- SIGNAL TO NOISE RATIO: Over 55 db at both 7 1/2 and 15 ips as defined by NARTB standards.
- DISTORTION: Less than 2% rms at maximum recording level.  
Less than 1% rms at standard recording level.
- OUTPUT TERMINATION: 600 ohms balanced — termination switch is provided; monitor jack for connection to a power amplifier; jack for 600 ohms headset.
- OUTPUT VOLTAGES: 0 VU or +4 dbm across 600 ohms balanced load or unbalanced load. 6 volts across 20,000 ohms.
- INPUTS: Microphone Input — 30 to 250 ohms.  
Bridge Input — 20,000 ohms.
- INPUTS: Line Input — 600 ohms balanced. 600 ohms unbalanced.
- MONITORING SWITCH: Rapid switching from monitoring tape playback to monitoring live input.
- METER SWITCH: Provides rapid switching for indicating:  
Playback level; Record level; Bias level; Erase Current.
- METER: VU.
- CONTROLS: Input jack, output jacks and meter — located on front panel.
- ERASE OSCILLATOR: 85 kc adjustable. Screwdriver adjustment permits rapid setting of erase current level.
- BIAS LEVEL: Screwdriver adjustment permits easy setting of bias level.
- SIZES: (Console) 34" x 23" x 25 1/2" deep.  
(Rack) transport 19" x 15 3/4" x 5" deep.  
Amplifier 19" x 7" x 14" deep.  
(Portable) 2 cases 20" x 20" x 9" high.

### ORDERING INFORMATION

- Console model, full track, as illustrated ..... 938-C
- Rack model, full track, as illustrated ..... 938-R
- Two-cast portable model, full track, as illustrated ..... 938-P

**NOTE:** All models available in half track at no extra cost, where stated on order. Stereophonic models also available.

# MAGNECORD PROFESSIONAL TAPE RECORDERS

## MAGNECORD M-90 SERIES



M-90ACC



M-90AC

The Magnecord M-90 incorporates the very latest advances in fine recording techniques. Quick slot-loading and interlocking push-button controls permit instantaneous selection of desired operation with safety and reliability. The tape is automatically lifted from the heads during rewind or "high forward" to reduce head wear to a minimum. Precision-made heads provide extended range to 20,000 cycles per second. High speed cueing control permits cueing during high forward or rewind. Record interlock minimizes danger of accidental tape erasure.

### SPECIFICATIONS

- TAPE SPEED: 7½ & 15 ips (3¾ and 7½ ips available on special order).
- STARTING TIME: less than 0.1 sec.
- STOPPING TIME: less than 2" of tape at 15 ips.
- TIMING ACCURACY: ±3 sec. in 30 min.
- FLUTTER & WOW: less than 0.1% max. at 15 ips, less than 0.15% max. at 7½ ips less than .3% max. at 3¾ ips.
- REWIND AND HIGH FORWARD: 10"—2400 ft. reel less than 55 sec.
- FREQUENCY RESPONSE: 30 to 15,000 ±2 db 15 ips, 40 to 12,000 ±2 db 7½ ips 30 to 15,000 ±4 db 7½ ips, 50 to 7500 — 3¾ ips.
- SIGNAL-TO-NOISE: \*58 db at 7½ and 15 ips.

- MONITORING: phone jack on panel for monitoring.
- PANEL: standard 19-inch rack.
- SIZE AMPLIFIER: 19 x 5½.
- TRANSPORT SIZE: 19 x 12¼.
- POWER SUPPLY SIZE: integral with amplifier panel.
- POWER CONSUMPTION: 290 watts.
- M-90ACC: Net Wt.: 180 lbs. Size: 28" wide x 28" deep x 41" Net Wt.: high.
- M-90AC: Net Wt.: 92 lbs.
- M-90ACX: Net Wt.: 74 lbs. Size: 19" wide x 17½" high.
- \* S/N for ½ track is 55 db.

### ORDERING INFORMATION

- Console model includes transport and amplifier in beautiful cabinet 28" wide, 28" deep and 41" high M-90ACC
- Portable model in two cases including transport and amplifier M-90AC
- Rack model includes transport and amplifier for rack mounting M-90ACX

## MAGNECORD PT63 SERIES



For faithfully recording and reproducing any frequency in the audio range, the Magnecord PT63 has won nation-wide popularity, as well as for its longevity and dependability in service. Separate erase, record and playback heads allow monitoring from the tape. Full or half-track heads should be specified as desired. Two-speed motor and capstan change give speeds of 3¾ and 7½ ips or 7½ and 15 ips. Frequency response is from 50 to 15,000 cycles ±2 db at 15 ips.

The popular and versatile PT63-J Amplifier Unit combines separate record and playback amplifiers, with a full 10 watts of audio power. Five-inch monitor speaker as well as outlet for connecting external speaker. Three inch VU meter for bias record and playback. Microphone input 50 or 250 ohms balanced or unbalanced. Bridge input, unbalanced. Switch for equalization of 15 and 7½ ips (3¾ ips equalizer available at additional charge). Phone jack from tape or input. Line output, 600 ohms 12 dbm balanced; speaker output, 4 or 16 ohms, 10 watts.

### ORDERING INFORMATION

- Basic recorder in portable carrying case PT63-A2HZ
- Recorder less case PT63-A2HZX
- Case 91X3318
- Record-playback amplifier in case. Includes connector cables PT63-J
- Same, less case PT63-JX
- Case 91X1890

# MAGNECORD PROFESSIONAL TAPE RECORDERS

## MAGNECORD MODEL 728



Recording perfection and brilliant reproduction are combined in this portable Magnecord, the professional model 728.

### SPECIFICATIONS

**TAPE SPEEDS:** Two speeds, direct drive, 7½ ips and 15 ips or 3¾ ips and 7½ ips available.  
**TIMING ACCURACY:** ±3 seconds in 30 minutes.  
**FREQUENCY RESPONSE:** 30 to 18,000 cps, ±2 db at 15 ips.  
**FLUTTER AND WOW:** 0.1% at 15 ips; 0.15% at 7½ ips.  
**REEL SIZE:** Up to 10½ inches NAB.  
**PANEL SIZE:** 17⅞" wide x 12⅞" high.

### ORDERING INFORMATION

Magnecord Recorder ..... Model 728

## MAGNECORD PT6 SERIES



The PT6-6AJ has through long, hard hours of operation proven itself to be the work horse of the industry. A new, 19" front panel allows the PT6-6 to be rack mounted as well as carried in a portable case. Housed in two separate cases for convenience, the PT6-6 becomes the most practical professional portable in the field.

### SPECIFICATIONS

**FREQUENCY RESPONSE:** 50 to 15,000 cps ±2 db at 15 ips.  
 50 to 7,500 cps ±2 db at 7.5 ips.  
**INPUT LEVEL:** Sensitivity — 105 dbm for zero level recording.  
 Maximum level — 35 dbm.  
**INPUT IMPEDANCE:** 50 ohm balanced. High impedance bridge (phone jack).  
**SIGNAL TO NOISE RATIO:** 50 db.  
**TOTAL HARMONIC DISTORTION:** 10 watts out, less than 2%.  
**FLUTTER:** .3% at 15 ips. .5 at 7½ ips.  
**DIMENSIONS:** Amplifier — 8" deep, 7" high, 19" wide without carrying case. 13" deep, 8" high, 20" wide with carrying case.  
**MECHANICAL UNIT:** 11" deep, 7" high, 19" wide without carrying case.  
**WEIGHT:** Amplifier — 21 lbs. with carrying case.  
**TRANSPORT:** 26 lbs. in case.

### ORDERING INFORMATION

Recorder in Case ..... PT6-6A  
 Recorder Less Case ..... PT6-6AX  
 Carrying Case for Recorder ..... 7A  
 Record/Playback Amplifier in Case ..... PT6-6J  
 Record Playback Amplifier less Case ..... PT6-6JX  
 Amplifier Case ..... 7C

## MAGNECORD S36-B



Here is a widely used professional tape recorder in the low priced field for real commercial results. Single unit has Hi-Z microphone and unbalanced bridging input. Playback amplifier output: 600 ohms balanced or unbalanced. Output level: +8 VU. Response 50-15,000 cycles. Tape speeds 7½" and 15" by capstan change. Hysteresis synchronous motor drive. Uses 7" reels. Rewinds in 40 seconds. Illuminated VU meter. Wow flutter 0.3%. Full track NAB response. Panel 7" x 19" for rack mounting.

### ORDERING INFORMATION

Tape recorder rack mount ..... S36-BX  
 Same as above in portable carrying case ..... S36-B

## RECORDING TAPE

(Minnesota Mining & Mfg. Co.)

Recording tape is carried in generous quantity at all Gates stock carrying points. Rapid turnover assures fresh stock at all times. Recording tape is prepaid to any place in the United States and quantity places are lower (see price list). Unless otherwise stated, all tape is of Minnesota Mining manufacture.

SIZE	CAT. NO.
<b>Type 111 plastic base, red oxide coating:</b>	
¼" x 150' plastic 3" reel	111-1.5
¼" x 300' plastic 4" reel	111-3
¼" x 600' plastic 5" reel	111-6
¼" x 1200' plastic 7" reel	111-12
¼" x 2400' on hub	111-24H
¼" x 2400' on 10½" metal reel	111-24R
¼" x 4800' on hub	111-48H
¼" x 4800' on 14" metal reel	111-48R
<b>Type 120 high output plastic base, green coded:</b>	
¼" x 600' plastic 5" reel	120A-6
¼" x 1200' plastic 7" reel	120A-12
<b>Type 190 new thin type, 50% more recording time per reel:</b>	
¼" x 900' plastic 5" reel	190-9
¼" x 1800' plastic 7" reel	190-18
¼" x 3600' NARTB 10½" metal reel	190-36R
¼" x 3600' on hub	190-36H
¼" x 7200' on 14" metal reel	190-72R
¼" x 7200' on hub	190-72H
<b>Type 150 weather balanced extra play:</b>	
¼" x 900' on 5" plastic reel	150-9
¼" x 1800' on 7" plastic reel	150-18
¼" x 3600' on hub	150-36H
¼" x 3600' on 10½" metal reel	150-36R
¼" x 7200' on hub	150-72H
¼" x 7200' on 14" metal reel	150-72R
<b>NEW 200 DOUBLE PLAY TAPE:</b>	
¼" x 2400' on 7" reel	200-24
¼" x 4800' on 10½" NARTB metal reel	200-48R
<b>SPECIAL TAPES:</b>	
Splicing tape ½" x 150'	41-½S
Leader timing tape, ¼" x 150'	43-1.5
Head alignment tape 15" sec.	200
Head alignment tape 7½" sec.	GR-LST
<b>EMPTY REELS WITH MAILING CARTONS:</b>	
3" empty reel	RB-3
4" empty reel	RB-4
5" empty reel	RB-5
7" empty reel	RB-7
10½" empty reel	RB-10-½M

Quantity prices shown on price list — all tape prepaid anywhere in U. S. A.

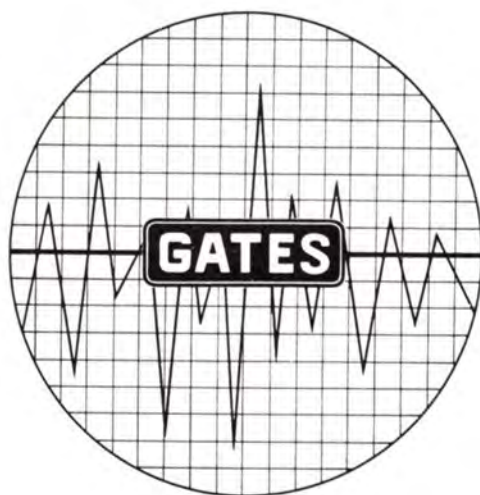

# **HIGH FREQUENCY AND COMMUNICATIONS TRANSMITTERS, ACCESSORIES**

## **PAGES**

<b>190-227</b>	<b>TRANSMITTING EQUIPMENT</b>
<b>228-232</b>	<b>ACCESSORIES, COMMUNICATIONS AND INDUSTRIAL</b>

# 50,000 WATT HIGH FREQUENCY BROADCAST TRANSMITTER

Model HF-50C

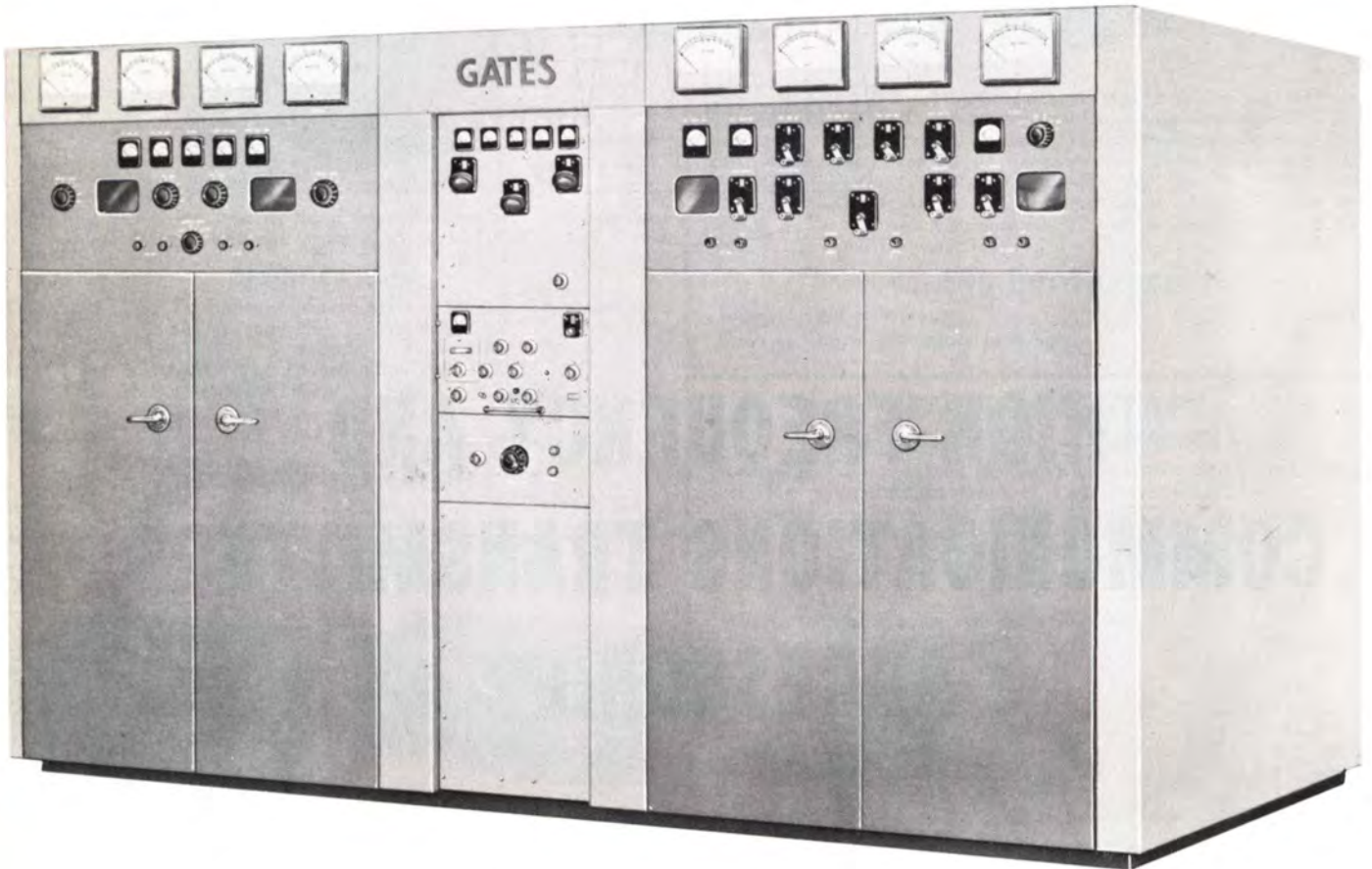

The Gates HF-50C high frequency broadcast transmitter is high level plate modulated and capable of delivering 55,000 watts of power into a balanced line of 300-800 ohms on any frequency between 4-30 MCS. Outstanding advantages of the HF-50C are: small, compact size requiring a minimum of floor space-transmitter proper only 6½ ft. high, 11 ft. wide, 61⅝ inches deep; rapid frequency change; interchangeability of PA and modulator tubes; less tube types; longer tube life; and low power consumption—only 100 KW at average programming. Introduced in 1959, following wide acceptance of similar models now in use at station ELWA, Morovia, Liberia and the Dominican Republic, the HF-50C has been especially designed to operate in world wide climates and for the most rigorous demands of continuous duty.

**HF-50C 50,000 WATT HIGH FREQUENCY BROADCAST TRANSMITTER**

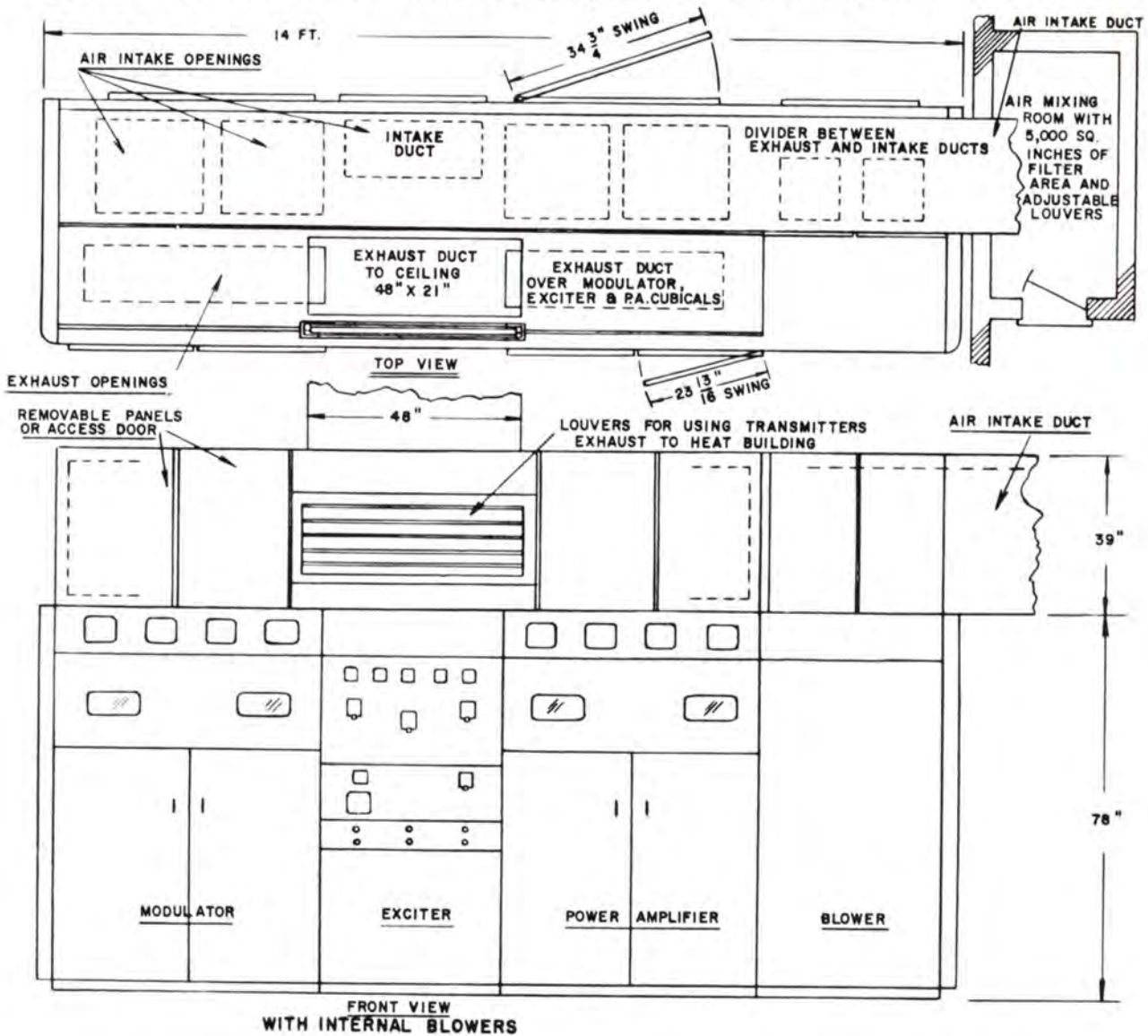

**CONSTRUCTION:** The HF-50C consists of three main cubicles; audio driver and modulators, RF exciter-driver control cubicle and power amplifier cubicle. All cabinets are accessible from front and rear and vertical construction design permits easy servicing.

**RADIO FREQUENCY SECTION:** The exciter RF/driver along with associated separate power supplies are built into the center cubicle. Rated at 85 watts output, the exciter has a crystal selection system with 10 positions selectable from the front panel. (Dual exciter units can be provided where desired.) The 3KW driver is continually adjustable and is very conservatively rated which provides reserve power for driving the final amplifier.

**POWER AMPLIFIER SYSTEM:** The power amplifier uses two Federal Type 6804 forced air cooled tubes in push-pull. Since one tube is capable of delivering 50 KW output, a tremendous reserve of power is available.

**AUDIO SYSTEM:** All audio stages are located in the modulator cubicle. The 1st audio stage uses two 6146 tubes push-pull. The 2nd audio stage uses two 813 tubes operating as a push-pull amplifier. The audio driver stage uses two 833A triodes operating in a direct coupled cathode follower circuit. Adjustment of bias resistors, feedback and carrier hum are simple. Over-all feedback is approximately 15 db an optimum value for minimum distortion and noise.



**HF-50C 50,000 WATT HIGH FREQUENCY BROADCAST TRANSMITTER**

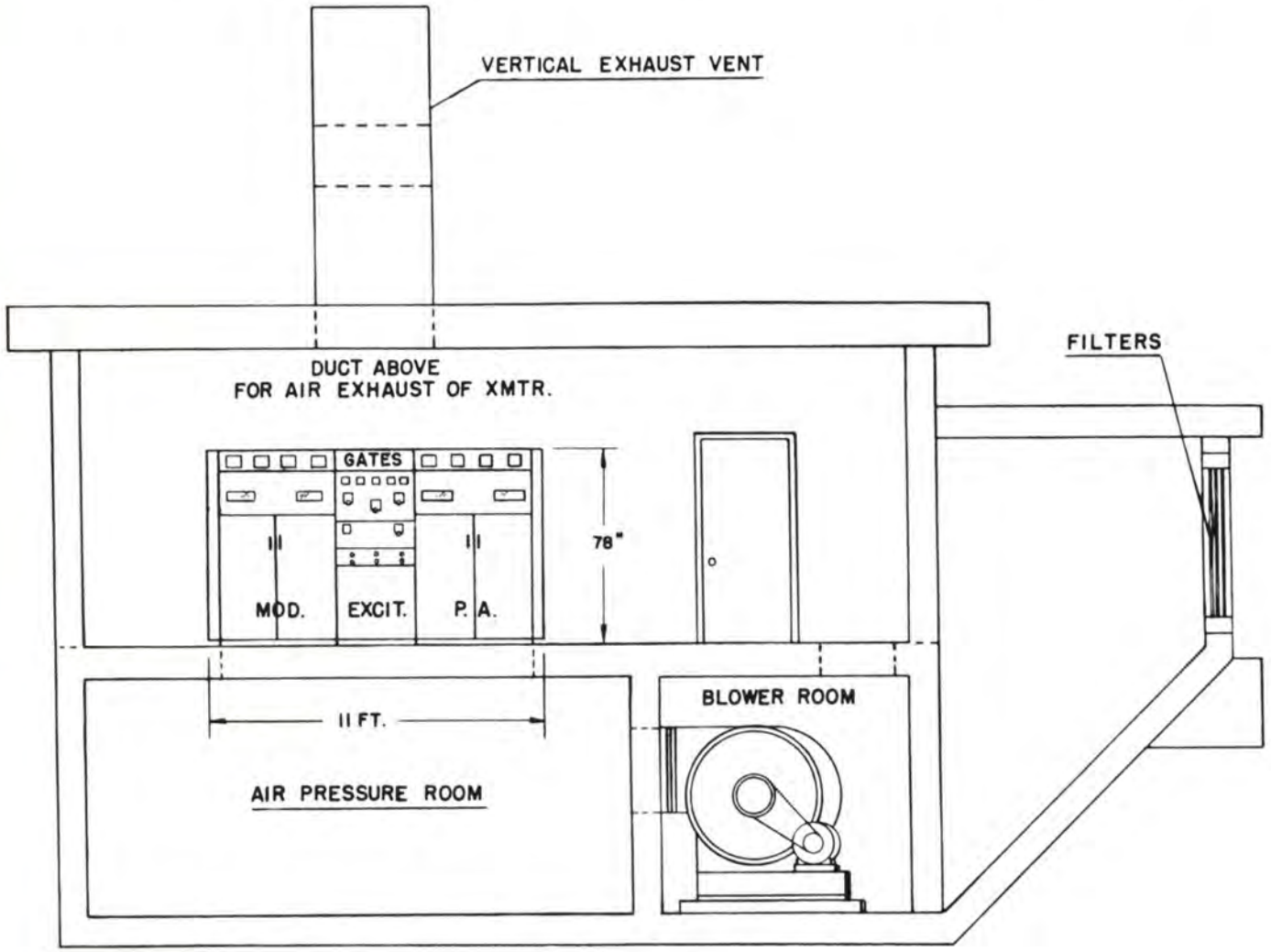

**WITH EXTERNAL BLOWER**

**MODULATION:** Type 6804 tubes used in the PA system are also used as modulators. High level plate modulation is used in the HF-50C transmitter, which provides for a constantly available reserve of audio power. The HF-50C modulator is designed for continuous duty at extremely high levels of average modulation in order to provide for the most possible coverage for this transmitter power.

**POWER SUPPLIES:** All power supplies in the HF-50C transmitter utilize silicon rectifiers for long trouble-free service throughout a wide range of temperature and humidity. This includes the main high voltage rectifier which provides approximately 10.5 KV plate for the final amplifier and modulator tubes. The use of silicon rectifiers in

the design of the HF-50C has provided a 50 KW HF broadcast transmitter with a minimum space requirement. Separate high voltage plate transformers are used to provide for easier installation and more dependable service.

**CONTROL:** The HF-50C is provided with a generous supply of overload and under-voltage relays. Every circuit large or small is protected most adequately.

**INSTALLATION:** The HF-50C has been designed for maximum installation flexibility to fit various situations. It can be supplied with either internal or external blowers to meet your exact installation needs. Gates engineers are available to assist in the installation planning at all times.

## HF-50C 50,000 WATT HIGH FREQUENCY BROADCAST TRANSMITTER

### OUTSTANDING FEATURES

**INTERNAL OR EXTERNAL BLOWERS:** The HF-50C is 100% air cooled with either internal or external blowers. This is a Gates exclusive made possible by very careful and detailed mechanical design. With internal blower arrangements a 3 ft. wide cubicle is added to the right side of the PA cubicle for PA cooling. This increases over-all length to 14 ft. Modulator and driver cubicle have self-contained blowers. No changes in transmitter proper are necessary for external blower arrangement. Air is controlled to insure maximum cooling of all critical areas. Exhaust can be vented out of the building or used for heating in winter.

**REGULATION:** Filament voltages for the entire transmitter are regulated. This is handled by a Gates three-phase voltage regulator with electronically controlled motor driver transformers keeping filament voltage within  $\frac{1}{2}\%$  at all times.

**METERING:** 14 meters are provided. 8 are located along the top of the power amplifier and modulator cubicle. 5 are located along the upper panel of the exciter RF/driver cubicle. The 14th meter is a multi-meter on the 85 watt exciter unit, which provides for complete metering of the oscillator and RF amplifier stages up to the driver stage. Easy, quick readings can be taken at any time.

**BAND SWITCHING:** A new concept of plate tank circuit design makes necessary only one adjustment other than from the front panel, to provide for continuous coverage over the range of 4-30 MCS. No plug-in coils are used in the HF-50C transmitter and frequency change can be accomplished in less than five minutes.

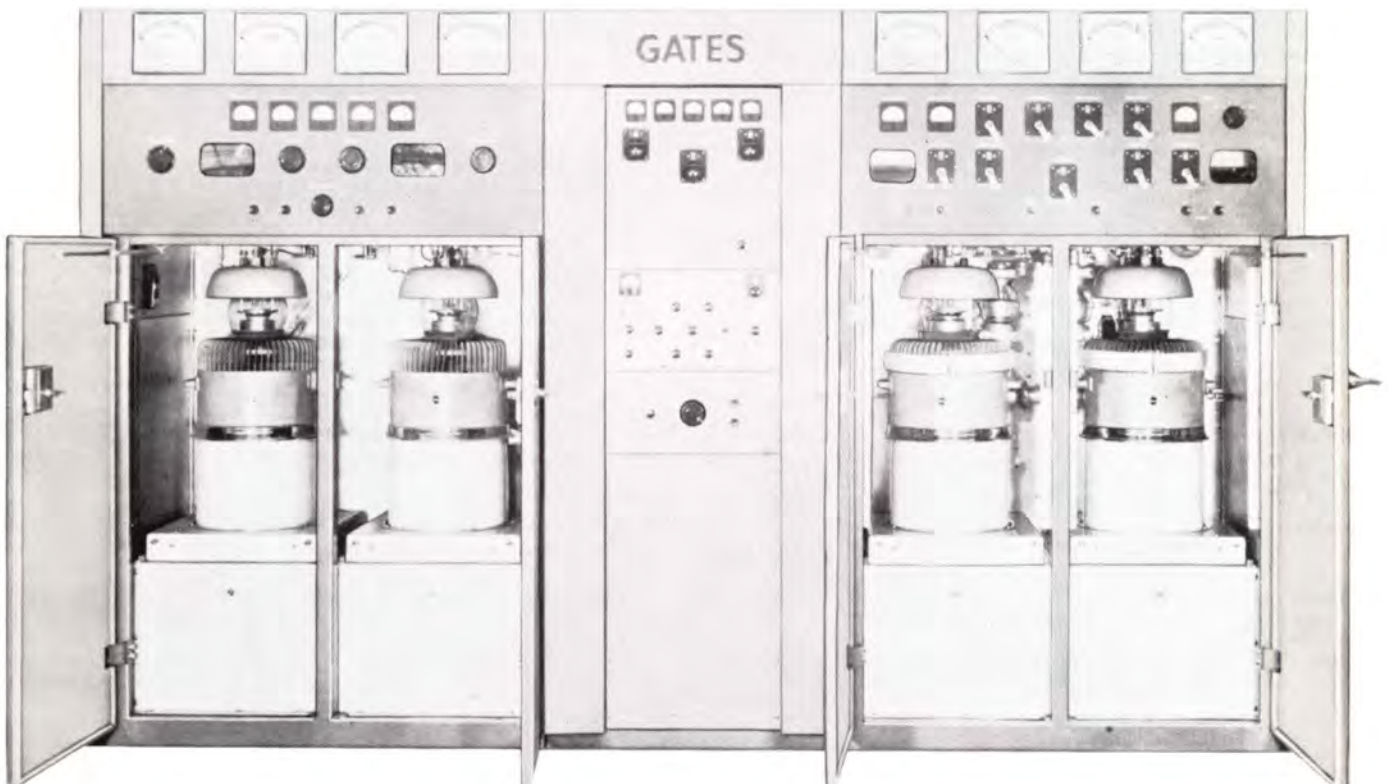

# HF-50C 50,000 WATT HIGH FREQUENCY BROADCAST TRANSMITTER

## SPECIFICATIONS — ELECTRICAL

**POWER OUTPUT:** 50,000 watts.  
**OUTPUT IMPEDANCE:** 300-800 ohms balanced.  
**RF RANGE:** 4-30 Mc.  
**FREQUENCY STABILITY:** Capable of .003% or better.  
**RF HARMONICS:** Meets or exceeds FCC requirements.  
**AUDIO FREQUENCY RESPONSE:** 85% modulation (50-10,000 cycles)  $\pm 1\frac{1}{2}$  db.  
**AUDIO HARMONIC DISTORTION:** (0-95% modulation from 50 to 7500 cycles) 4% or less.  
**AUDIO INPUT:** 100% modulation sine wave, 400 cps. +10 dbm.  
**AUDIO INPUT IMPEDANCE:** 600 ohms.  
**PRIMARY VOLTAGE:** 460 volt, 50/60 cycle, 3-phase.  
**POWER CONSUMPTION:** Carrier 90 Kw at 90% PF, Average Program 100 KW at 90% PF 100% modulation 135 KW at 90% PF.  
**CARRIER SHIFT:** (100% modulation with 400 cps) 5% or better.  
**TUBES (RF + Audio)**  
 Exciter Unit (1) 5763, oscillator, (1) 5763 1st buffer, (2) 6146 output, (1) OB2 screen clamper, (1) 6AQ5 screen clamper, (1) 12AU7 keyer. (1) 6AL5 bias rectifier, (2) 5R4GYA rectifier.  
 RF Driver (1) 6076

Power Amplifier (2) F-6804 push-pull  
 Modulator (2) F-6804 class "B"  
 Audio Drivers (2) 833A's cathode follower  
 Second Audio (2) 813's push-pull  
 First Audio (2) 6146  
**TOTAL NUMBER OF TUBES:** 21.  
**TOTAL TUBE TYPES:** 13.  
**SIZE:** 6 $\frac{1}{2}$ ' high, 11' wide, 5' deep (with external blower)  
 6 $\frac{1}{2}$ ' high, 14' wide, 5' deep (with internal blower)  
**WEIGHT:** 26,850 lbs. packed wt.; cubage 1480 with external blower.  
 26,859 lbs. packed weight, cubage 1555 with internal blower.  
**CRYSTAL:** H17 crystal unit JK 02, 6.3 volt A.C., heater oven.  
**MODULATION CAPABILITY:** (30-7500 cycles) 100% High level class "B".  
**RADIO TELEPHONE MODEL:**  
 This model is available for radio-telephone service as desired.  
**RADIO TELEGRAPH MODEL:**  
 The Gates HF-50TX radio-telegraph transmitter is identical to the transmitter described herein except it does not include the modulator cubicle. It is designed for high-speed keying or FSK service. Size is 4 ft. narrower than broadcast model. All other details are the same.

## ORDERING INFORMATION

Model HF-50C broadcast transmitter, 50,000 watts, with tubes.....	M-5924
Spare 100% tube complement for above .....	TK-367
FCC tube complement (required FCC spares) .....	TK-368
Spare crystal and holder .....	JK02C, H-17

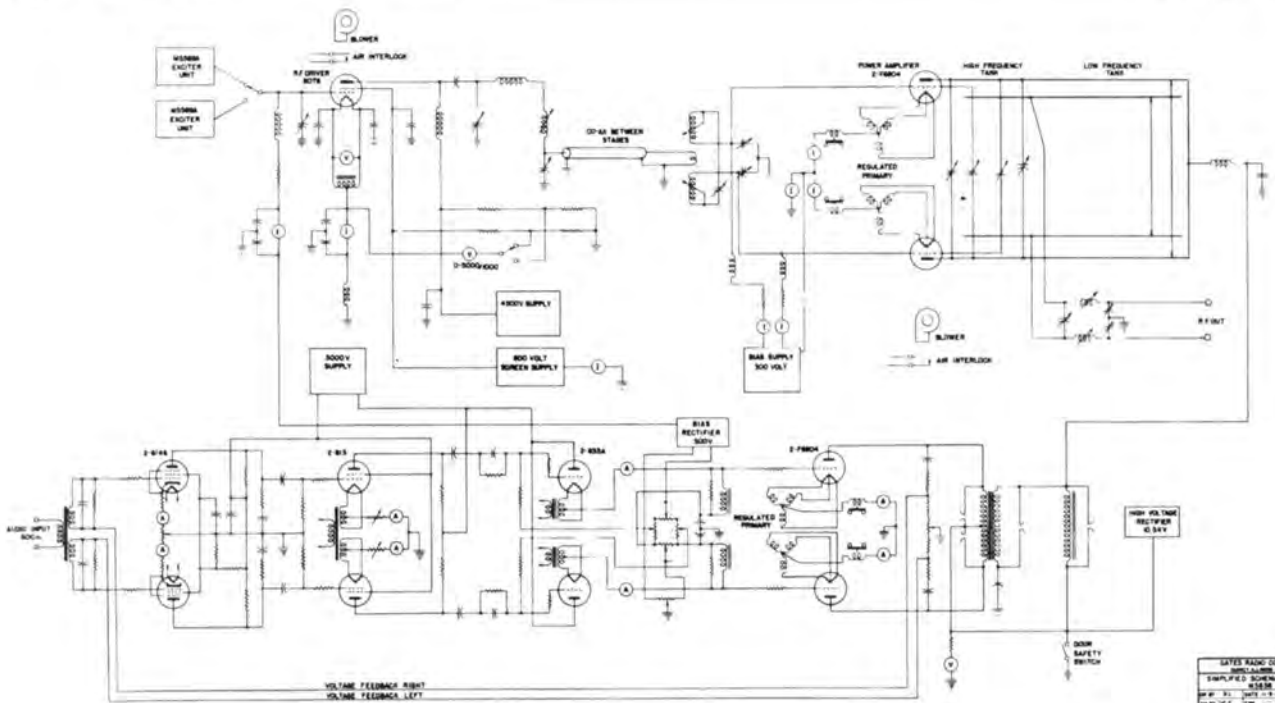

# 100,000 WATT HIGH FREQUENCY BROADCAST TRANSMITTER

Model HF-100C

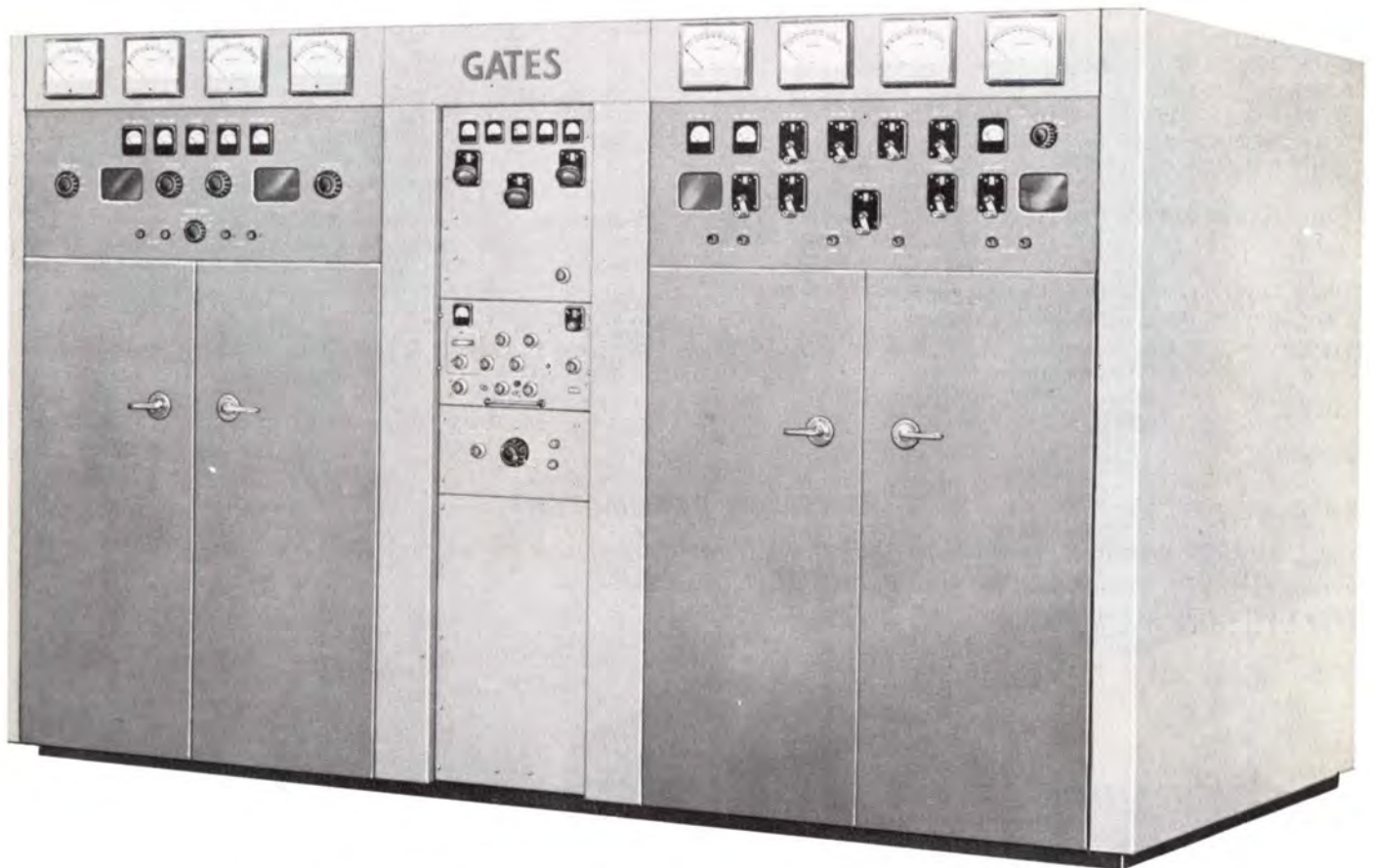

Designed to operate in world wide climates under the rigorous demands of continuous duty, the new HF-100C possesses compact size, rapid frequency change, interchangeability of PA and modulator tubes, less tube types, longer tube life, and low power consumption.

**CONSTRUCTION:** The HF-100C consists of three main cubicles that are accessible from front and rear: audio driver and modulators, RF exciter-driver control cubicle and PA cubicle.

**RADIO FREQUENCY SECTION:** The RF exciter-driver is the center cubicle and is rated at 85 watts output. Exciter has a crystal selection system with 10 positions selectable from the front panel. 6 KW driver is conservatively rated with plenty of reserve power.

**POWER AMPLIFIER SYSTEM:** Power amplifier uses two Federal 6804 forced air cooled tubes in push-pull.

**AUDIO SYSTEM:** All audio stages are located in the modulator cubicle. The 1st audio stage uses two 6146 tubes push-pull. The 2nd audio stage uses two 813 tubes operating as a push-pull amplifier. The audio driver stage uses 5736 triodes operating in a direct coupled cathode follower circuit. Adjustment of bias resistors, feedback and carrier hum are simple. Over-all feedback is approximately 15 db an optimum value for minimum distortion and noise.

**MODULATION:** Type F6804 tubes used in the power amplifier

are also used as modulators. High level plate modulation is used in the HF-100C transmitter, which provides for a constantly available reserve audio-power. The HF-100C modulator is designed for continuous duty at extremely high levels of average modulation.

**POWER SUPPLIES:** All power supplies in the HF-100C transmitter utilize silicon rectifiers. This includes the main high voltage rectifiers which provide approximately 15 KV plate for the modulator tubes and approximately 12.5 KV on the final RF amplifier. Separate high voltage plate transformers for modulator and RF amplifier are used.

**BAND SWITCHING:** A new concept of plate tank circuit design makes necessary a minimum of adjustments other than from the front panel, to provide for continuous coverage over the range of 4-30 MCS. No plug-in coils are used in the HF-100C transmitter and frequency change can be accomplished in less than five minutes.

**CONTROL:** The HF-100C is provided with a generous supply of overload and under-voltage relays. Every circuit large or small is protected most adequately.

# HF-100C 100,000 WATT HIGH FREQUENCY BROADCAST TRANSMITTER

## SPECIFICATIONS

POWER OUTPUT: 100,000 watts.  
 OUTPUT IMPEDANCE: 300-800 ohms.  
 RF RANGE: 4-30 MC.  
 FREQUENCY STABILITY: 0.03% or better.  
 RF HARMONICS: Meets or exceeds FCC requirements.  
 AUDIO FREQUENCY RESPONSE: 85% modulation (50-10,000 cycles)  $\pm 1\frac{1}{2}$  db.  
 AUDIO HARMONIC DISTORTION: (0-95% modulation from 50 to 7500 cycles) 4% or less.  
 AUDIO INPUT: 100% modulation sine wave, 400 cps +10 dbm.  
 AUDIO INPUT IMPEDANCE: 600 ohms.  
 PRIMARY VOLTAGE: 460 volt  $\pm 5\%$ , 3 phase, 50 or 60 cycles as specified.

POWER CONSUMPTION: Carrier 157 KW.  
 Average Program 173 KW.  
 100% Modulation 255 KW.  
 CARRIER SHIFT: (100% modulation with 400 cps) 5% or less.  
 TUBES (RF & AUDIO):  
 Exciter Unit: (1) 5763 oscillator, (1) 5763 second buffer, (2) 6146 output, (1) OB2 screen clamper, (1) 6AQ5 screen clamper, (1) 12AU7 keyer, (1) 6AL5 bias rectifier, (2) 5R4GYA rectifiers.  
 RF Driver: (2) 6076 Power Amplifier, (2) F6804 push-pull Modulators; (2) F6804 class "B". Audio Drivers: (2) WL5736 cathode follower. Second audio; (2) 813's push-pull. First audio; (2) 6146.  
 TOTAL NUMBER OF TUBES: 22.  
 TOTAL TUBE TYPES: 13.  
 SIZE: 6 $\frac{1}{2}$  ft. high, 14 ft. wide, 5 ft. deep with external blower.  
 CUBAGE: 1555.

## ORDERING INFORMATION

Model HF-100C broadcast transmitter, 100,000 watts, with tubes, one crystal and oven .....	M-5966
Spare 100% tube complement for above .....	TK-376
Spare crystal and holder .....	JKO2-H17



# 20,000 WATT HIGH FREQUENCY BROADCAST TRANSMITTER

Model HF-20B

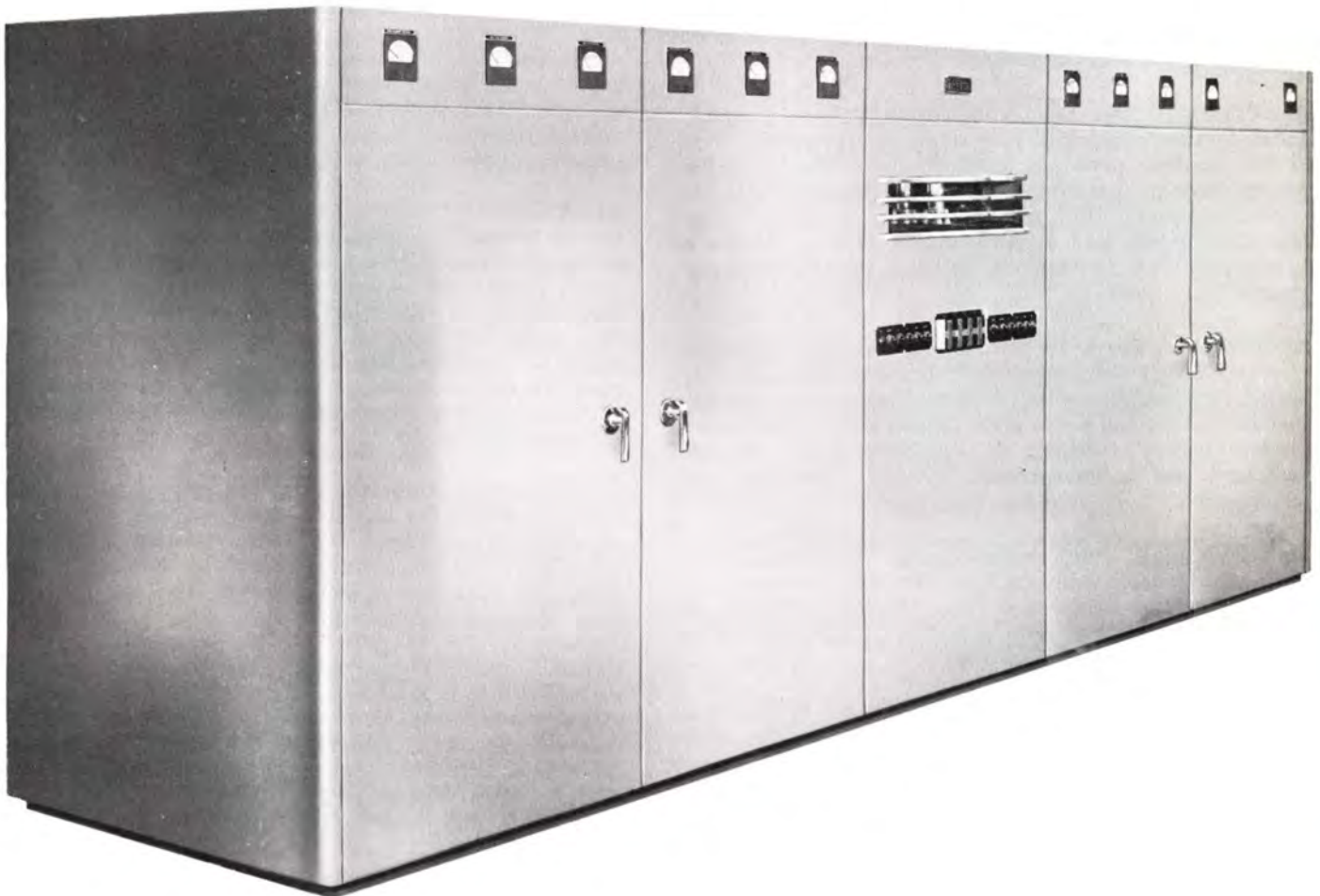

Now in service around the world in such places as Indonesia, Siam, Israel, Nigeria, Viet Nam, the Dominican Republic and many other countries, providing reliable service in the international broadcast and communication bands is the Gates HF-20B 20,000 watt high frequency broadcast transmitter. The HF-20B covers the entire frequency range between 4-22 Mc. An additional set of frequency determining components is available where frequencies down to 2 MC are desired. With two other models available for telegraph (HF-20TX) and radio telephone transmission (HF-20CX) all models are basically the same as pictured above except the HF-20TX which has no modulator cubicle and therefore only four cabinets.

**RADIO FREQUENCY SECTION:** Five RF stages are headed by a detachable "oscillator-1st IPA" unit. Positions for four crystals are switch selectable. All crystals are temperature controlled for 0.003% accuracy. Attachment of frequency shift keyer or external VFO is provided for. All RF stages, except the final power amplifier, are self-neutralized. In the keyed models (telegraph) the 2nd IPA/doubler stage is keyed electronically. RF drive to the final is in abundance by use of push-pull 4-250A tetrodes. In the final power amplifier, four 3X2500F3 tungsten filament tubes are operated in push-pull parallel.

**FREQUENCY AND COVERAGE:** With exception of the final latch-on tank coil, tune-up is from the front panel or continuously variable between 4-22 Mc. This is also true in the output coupling network. The tank coils may be changed in less than a minute and coils are supplied for all 4-22 frequencies. Veeder counters reading to 1/10 turn permit accuracy logging of all tuned circuits for quick frequency change.

**OUTPUT COUPLING:** RF impedance between 300-800 ohms are matched by means of inductive coupling to

## HF-20B 20,000 WATT HIGH FREQUENCY BROADCAST TRANSMITTER

the PA tank and feeding a balanced matching network having series variable coils and parallel variable vacuum capacitors. Both variable coils and capacitors have counter type tuning controls for accurate logging.

**AUDIO SECTION:** All modulated models have a superb audio system consisting of four stages, all push-pull. Modulators are four push-pull 3X300F3 tubes. Though drive requirements to these tubes are low, Gates engineers developed a unique and highly effective coupling transformer to greatly add to performance. Over-all feedback is employed as an adjunct to excellent possible performance without feedback.

**METERING:** There are no multi-meters. Few transmitters are so well complemented with meters. 29 in all. Individual current meters will be found in each power tube, modulator tube and audio drive tube cathode. This feature permits instant checking of important tubes without switching and is indispensable in daily operation and maintenance.

**KEYING:** In all keyed models an electronic keyer operates in conjunction with the 6146 IPA/doubler stage. An 812A tube is so biased that when the key is closed, no current is drawn. Keying up to 400 WPM with essentially square top wave form is obtained.

**POWER SUPPLIES:** Five major power supplies deliver plate and bias voltage to the HF-20B transmitter. Featured are the two separate and complete high voltage supplies. One is used for the radio frequency power amplifier and the other for the modulators. The resulting almost perfect regulation is quickly recognized by the engineer. Like-

wise, in case of failure of one power supply, the remaining one can be bussed in, operating the transmitter on reduced power until repairs are made. Each of these two main power supplies are full wave three phase, six tube supplies. Other individual supplies provide modulator bias voltage, power amplifier bias voltage and intermediate voltage for driver stages. The telegraph model has only one HV power supply as the modulator is omitted.

**RELAYS AND PROTECTION:** Primary magnetic breakers are inserted in all main primary lines. Individual supervisory overload relays are incorporated for the transmitter main overload, and for full protection against exciter failure, air failure, and for RF driver, power amplifier, audio driver and modulators. Included are secondary relays for door interlock and air cooling interlock. Automatic condenser discharge relay switch immediately discharges the main filter capacitors when the door interlocks are disengaged.

**RECYCLING:** Automatic recycling relay controls automatically where the carrier is disrupted, and attempts to reset the carrier four times before remaining off. Many times carrier interruption is caused by static discharges across the transmission line or tower base and this recycling feature is indispensable.

**PERFORMANCE:** Everything has been done to assure the HF-20B to be the finest. The long list of users includes major governments world-wide as well as international transoceanic radio communications and press services. HF-20B is definitely commercial all the way. Whether used 24 hours daily or in remote equatorial climate with temperature and humidity high, performance and reliability can be expected.

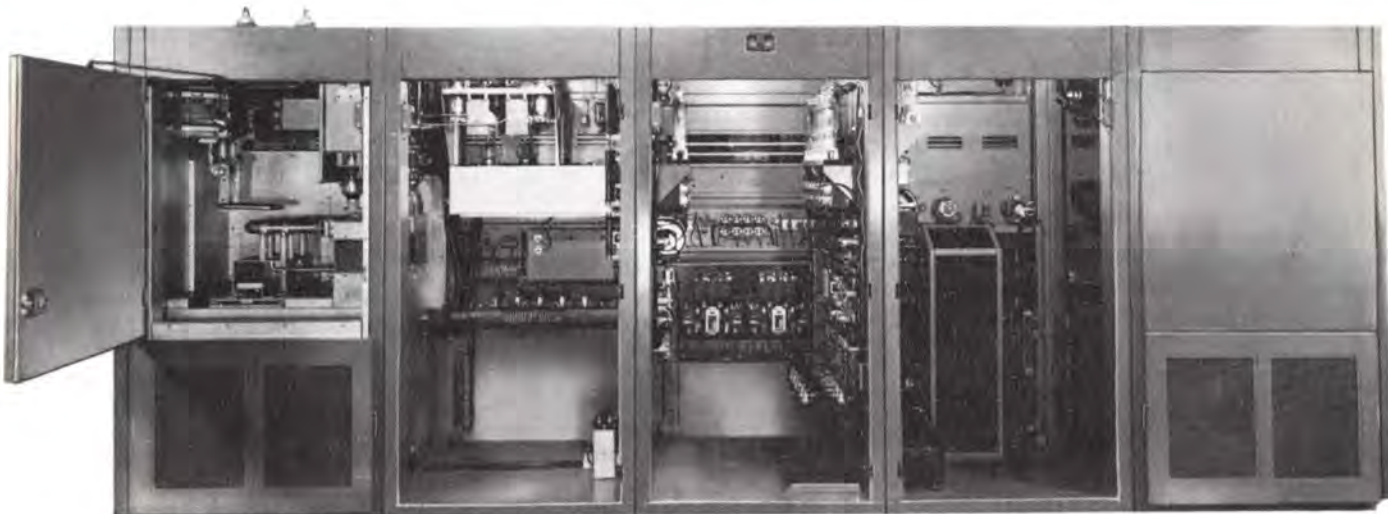

# HF-20B 20,000 WATT HIGH FREQUENCY BROADCAST TRANSMITTER

## SPECIFICATIONS

**POWER OUTPUT:** 4-18 Mc, 20,000 watts. 18-22 Mc, 16,000 watts.  
**OUTPUT IMPEDANCE:** 300-800 ohms balanced. Where 50 ohms unbalanced, so state when ordering.  
**FREQUENCY RANGE:** 4-22 Mc as supplied. Frequency determining kit for 2-4 Mc available where required.  
**RF STABILITY:** 0.003% or better.  
**RF HARMONICS:** Suppression of harmonics meets or exceeds FCC requirements.  
**POWER REDUCTION:** Low power tune-up switch provided.  
**AUDIO RESPONSE:**  $\pm 1\frac{1}{2}$  db 50-10,000 cycles.  
**DISTORTION:** \*4% or less 50-7500 cycles.  
**AUDIO INPUT LEVEL:** +10 dbm  $\pm 2$  db for 100% modulation.  
**AUDIO INPUT IMPEDANCE:** 600 ohms normal, (multi-impedance input transformer)  
**PRIMARY VOLTAGE:** 230 volts, 3 phase, 50/60 cycles. Other primary voltages or line frequencies available on special order.  
**POWER CONSUMPTION:** 0 Modulation 37 Kw, telegraph, 34 Kw. Average modulation, 43 Kw. 100% modulation (sine wave) 55 Kw.  
**CARRIER SHIFT:** 5% or less.

**TUBES:**  
 Radio frequency section —  
 6AG7 oscillator, 6AG7 1st IPA, 6146 2nd IPA, (2) 4-250A 3rd IPA, (4) 3X2500F3 power amplifiers.  
 Audio Section — (2) 6J7 1st audio, (2) 807 2nd audio, (2) 845 3rd audio, (4) 3X3000F1.  
 Power supplies — (12) 673 HV rectifiers, (4) 8008 LV rectifiers, (2) 866A LV rectifiers.  
 Keyer — (1) 812 keyer tube\*  
**TOTAL TUBES:** 37  
**TOTAL TUBE TYPES:** 11  
**SIZE:** HF-20B and HF-20BX, 210" wide, 49" deep, 78" high. Door swing, 40" front and rear. Floor space external units, 10' x 2 $\frac{1}{2}$ ".  
 HF-20TX, 175" wide, 49" deep, 78" high. Door swing, 40" front and rear. Floor space external units, 4' x 2 $\frac{1}{2}$ ".  
**WEIGHT:** HF-20B and HF-20BX — 17,500 lbs. packed, 14,000 lbs. net. HF-20TX — 14,000 lbs. packed, 11,500 lbs. net.

**CUBAGE:** HF-20B and HF-20BX — 1100 cu. ft. HF-20TX — 900 cu. ft.  
**FINISH:** Medium gray.  
**NOISE:** \*55 db below 100% modulation or better.  
**CRYSTAL POSITIONS:** Four with connection to FSK or external oscillator.  
**KEYING:** \*\*400 WPM with essential square top wave form, on-off keying.  
 \* Modulated models only.  
 \*\* HF-20BX, and HF-20TX only.  
**METERS:** RF output — (2), 2nd IPA cathode, (2) plate volts, (2) filament volts, line volts, osc. cathode, 1st IPA cathode, 2nd IPA grid, 2nd IPA cathode, 3rd IPA grid, 3rd IPA cathode, PA grid (2 meters), PA plate (4 meters), 1st audio cathode, 2nd audio cathode, 3rd audio cathode (2) modulators and total PA current and total modulator current.  
 \* Modulated models only.  
**EQUIPMENT SUPPLIED AS STANDARD:** 1 complete transmitter type as ordered.  
 1 100% set of tubes  
 2 instruction books

### ORDERING INFORMATION

- Model HF-20B high frequency, high fidelity broadcast transmitter, 4-22 Mc, complete with all coils and one set of tubes** ..... 60 cys. M-4748  
 50 cys. M-4748A
- Model HF-20TX high frequency, telegraph transmitter 4-22 Mc, complete with all coils and one set of tubes** ..... 60 cys. M-4780  
 50 cys. M-4780A
- NOTE:** The HF-20TX is basically the same as the HF-20B  
**NOTE:** except it has no modulator cubicle and there-  
**NOTE:** fore only four cabinets.
- Model HF-20BX high frequency, high fidelity broadcast transmitter, with 400 WPM keyer 4-22 Mc, complete with all coils and one set of tubes** ..... 60 cys. M-4778  
 50 cys. M-4778A
- Crystal and holder (state frequency)** ..... JK03, H-17  
**Spare 100% tube complement for HF-20B and HF-20BX transmitters** ..... TK-139  
**Spare 100% tube complement for HF-20TX transmitter** ..... TK-140

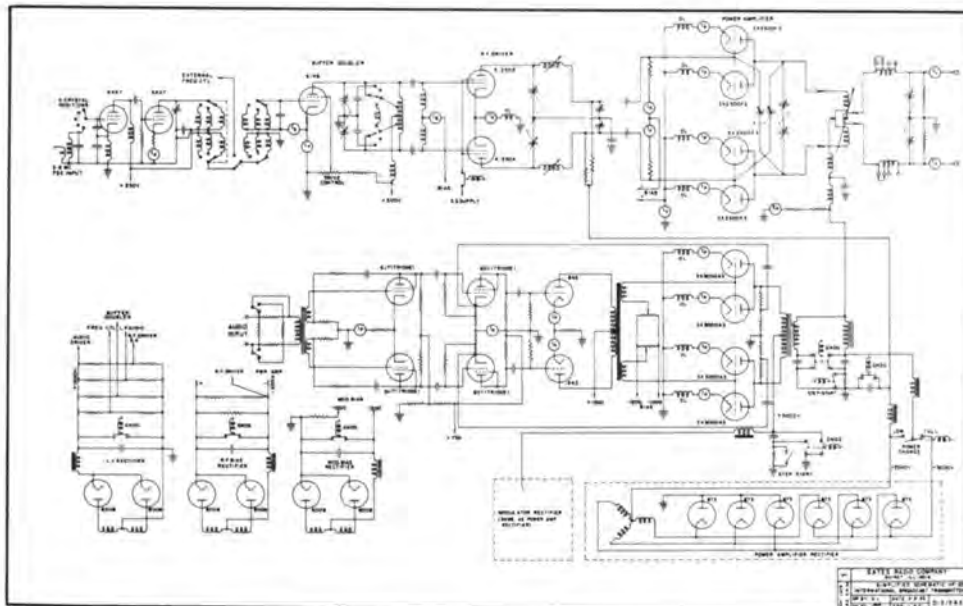



# 10,000 WATT HIGH FREQUENCY BROADCAST TRANSMITTER

Model HF-10B

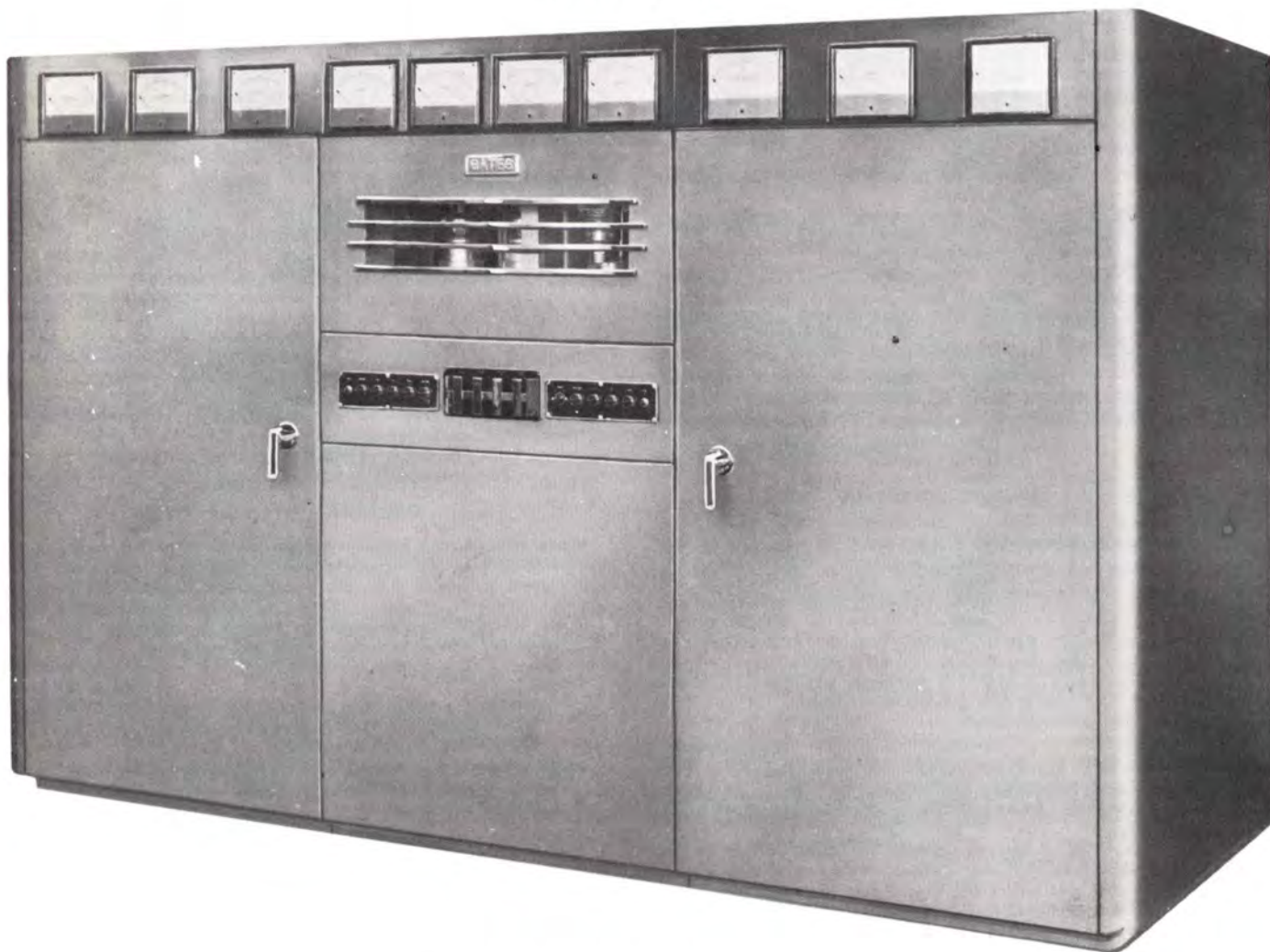

Renowned for reliable short wave broadcasting the world over, the HF-10B provides 10,000 watts output from 2-22 mc with high level modulation and uniform audio frequency response within 2 db between 30 and 10,000 cycles. These transmitters use 3X2500F3 tubes with thoriated tungsten filaments in both power amplifier and modulator sockets. Carrier frequency change may be made in seconds by continuously variable tuning and "latch on" take coil assemblies. New tube complement gives lower cost — longer life. Electronically modern and rugged, Gates Engineers have incorporated walk-in construction for easy servicing.

**MODELS AVAILABLE:** Variations of the HF-10B are listed under Ordering Nomenclature.

**BAND CHANGING** is quick and effective. All circuits are continuously variable and tuned from the front panel with the exception of the final tank coil. The Gates "latch on" system allows fast changing of this coil and completely eliminates complicated and costly tuning mechanisms. Four final tank coils are provided to cover the range from 2-22 Mc. Output pi —network tuning is also continuously variable.

**AUDIO** has four stages with abundance of drive and modulation capacity. Broadcast models employ both modulation transformer and reactor, while voice models are equipped with the new and exclusive Gates designed "Hi-cap" modulation transformer. This eliminates the modulation reactor—and yet, adds to modulator efficiency at voice frequencies.

**POWER SUPPLIES** are generous in both size and number. Main supply is full wave, three phase, utilizing either six 8008 or 673 tubes depending on model selected. Sepa-

## HF-10B 10,000 WATT HIGH FREQUENCY BROADCAST TRANSMITTER

rate supplies are incorporated for low voltage and bias circuits.

**PROTECTIVE DESIGN** is very complete. It includes primary circuit breakers in all major circuits and individual supervisory relays in all overload circuits such as RF driver, audio driver, final amplifier, modulator, air failure and exciter failure. Time delay, door interlock and pressure type blower air interlock protective equipment are all standard equipment.

**RECYCLING** is part of the HF-10B transmitter design. If, for any reason, the carrier should go off the air, the transmitter will automatically try to turn itself back on four times. Thus in case of a static discharge across the transmission line, for example, the transmitter will automatically turn back on.

**COOLING** is provided by one large squirrel cage blower which sends a torrent of air to the four 3X2500F3 tubes with excess air blowing into the transmitter proper. A diaphragm air pressure switch protects the tubes against air failure, and even a clogged air filter will activate the dia-

phragm pressure switch. An additional small blower feeds a small stream of air on the base of each high voltage mercury vapor rectifier tube.

**LOADING** from the push-pull power amplifier is balanced and will match from 300 to 800 ohm lines. Veeder counter dials on the variable pi-network coils allow accurate logging for frequency change.

**CONSTRUCTION:** All models consist of three cubicles or cabinets which bolt together easily after unpacking. At the bottom of each cubicle are large barrier terminal strips which transfer the wiring from cubicle to cubicle, eliminating any cabling after receiving. Full size front and back door are provided for the two outside cubicles. Layout design is such that the attendant may walk inside the back—rubber mats are provided. Such refinements as automatic internal lights that turn on when the back door is opened, and utility receptacles for drop cards or soldering iron are standard equipment. Floor space for the three cubicles or entire transmitter is 125" wide and 49" deep, exclusive of floor swing. Power transformer, modulator transformer, and reactor are mounted externally.

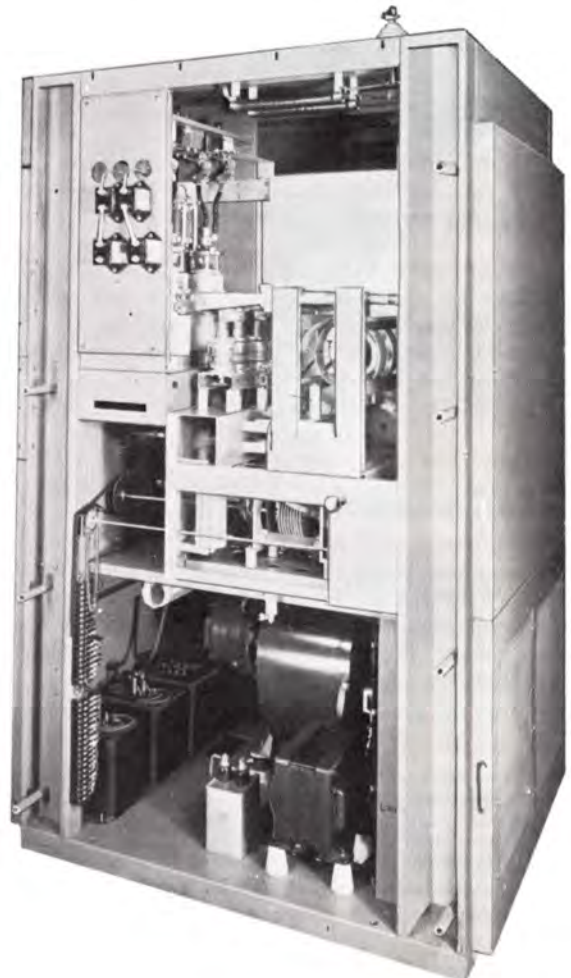
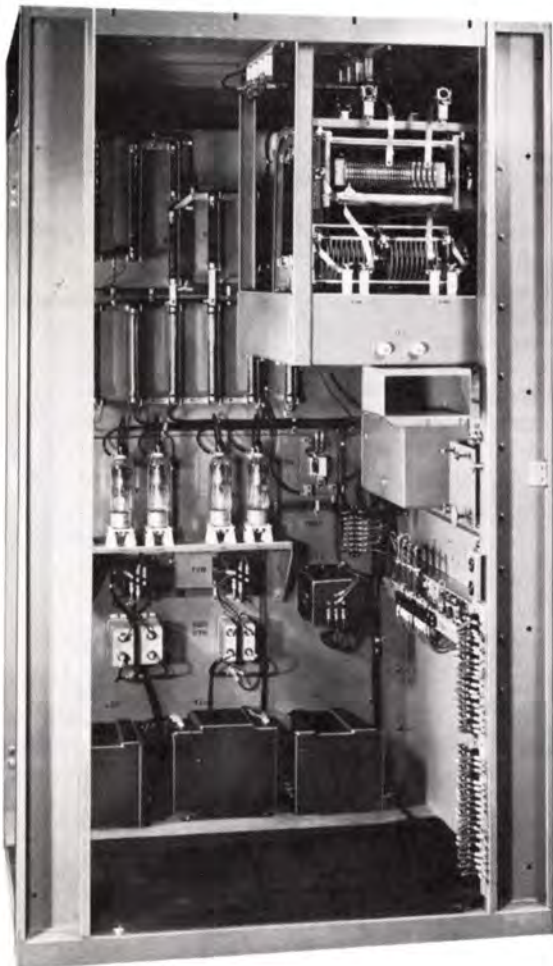

# HF-10B 10,000 WATT HIGH FREQUENCY BROADCAST TRANSMITTER

## SPECIFICATIONS

**POWER OUTPUT:** Model HF-10 (all models) 10,000 watts.  
**NOTE:** Power output above 18 Mc. will be slightly lower.

**OUTPUT IMPEDANCE:** 300-800 ohms balanced.

**FREQUENCY RANGE:** 2-22 Mc. 4-30 Mc. on special order.

**FREQUENCY STABILITY:** 0.003%.

**RF HARMONICS:** Meets or exceeds FCC requirements.

**FREQUENCY RESPONSE:** Plus or minus 1.5 db, 30-10,000 cycles broadcast model; plus or minus 3 db, 150-4000 cycles communications model.

**AUDIO INPUT:** +17 dbm,  $\pm 2$  db.

**AUDIO INPUT IMPEDANCE:** 600 ohms normal; (multi impedance input transformer).

**PRIMARY VOLTAGE:** 230 volts, 3 wire 50/60 cycles, 3 phase.

**POWER CONSUMPTION:** 100% Modulation — 30 Kw.

**POWER CONSUMPTION:** Average Modulation — 23 Kw.

**POWER CONSUMPTION:** PL Demand Carrier — 21 Kw.

**CARRIER SHIFT:** 5% or less at 100% modulation.

**TUBES:** (all models).  
 (2) 6AG7, (2) 4-125A, (2) 6J7, (4) 845, (4) 3X2500F3,  
 (4) 8008, (6) 673, (3) 807.

**TOTAL NUMBER OF TUBES:** 27.

**TOTAL TUBE TYPES:** 8.

**SIZE:** 125" long, 78" high, 49" deep, with door swing front, back doors 40". Size of largest cubicle 51" wide, 56" deep, 80" high. Space required for external transformers where used, 36" wide, 72" long, 36" high.

**NET WEIGHT:** 5,000 lbs.

**GROSS WEIGHT:** 7,000 lbs.

**CUBAGE:** 485 cu. ft.

**FINISH:** Medium gray.

**METERING:** Individual meters provided for; oscillator plate, first int. amp. plate, second int. amp. grid, second int. amp. plate, third int. amp. grid, third int. amp. plates (2 meters), power amp. grid, power amp. plates (2 meters), first audio plates, second audio plates, third audio plates, (2 meters), modulator plates (2 meters), filament volts, plate volts. (Telegraph models have audio meters omitted.)

**NOISE:** 60 db or better below 100% modulation, broadcast model; 45 db or better below 100% modulation, communications model.

**KEYING SPEED:** 400 WPM with pure square top wave form. Higher practical keying speeds up to 600 WPM easily possible.

**CRYSTAL POSITIONS:** 4 (additional crystal provisions available on special order).

## ORDERING INFORMATION

<p><b>Model HF-10B 10 Kw broadcast transmitter with all coils 2-22 mc, one set of tubes, less crystals and ovens</b> .....</p> <p><b>Model HF-10BX 10 Kw broadcast transmitter with electronic keyer added, with tubes, complete coil set 2-22 mc, one set of tubes but less crystals and ovens</b> .....</p> <p><b>Model HF-10C communications type telephone transmitter, 10,000 watts, with complete coil set 2-22 mc, complete set of tubes but less crystals and ovens</b> .....</p> <p><b>Model HF-10CX communications telephone and telegraph transmitter, 10,000 watts power, with electronic keyer, complete coil set 2-22 mc, complete set of tubes but less crystals and ovens</b> .....</p> <p><b>Model HF-10TX Telegraph transmitter only, 10,000 watts with complete coil set 2-22 mc, complete set of tubes but less crystals and ovens</b> .....</p> <p><b>HFTSX-10 Complete 100% tube set for 10 Kw telegraph models</b> .....</p> <p><b>HFTSB-10 Complete 100% tube set for 10 Kw telephone models</b> .....</p> <p><b>HFK Tube set for electronic keyer</b> .....</p>	<p>60 cys. M-3787 50 cys. M-3787A</p> <p>60 cys. M-3789 50 cys. M-3789A</p> <p>60 cys. M-3791 50 cys. M-3791A</p> <p>60 cys. M-3793 50 cys. M-3793A</p> <p>TK-255 TK-255 TK-253 TK-256</p>
--	--

**NOTE:** All models available in a 4-30 Mc version on special order.

### SPECIAL ORDERING INFORMATION

When ordering please give every detail possible, such as operating frequency or frequencies, line impedance, power line frequency and altitude of installation. Transmitters are normally carried in stock. When ordering do not overlook spare tubes and crystals, if these are desired. Both equipment and base spare parts lists will be supplied for your selection on request.

### SPECIAL MODELS

Gates engineers have endeavored to incorporate in these transmitters every engineering achievement you might desire. It is recognized that various primary voltages and frequencies exist in different parts of the world. Also, slight modifications to the standard specifications may be required in certain instances. If this is necessary, the modifications will be included for a modest increase in price.

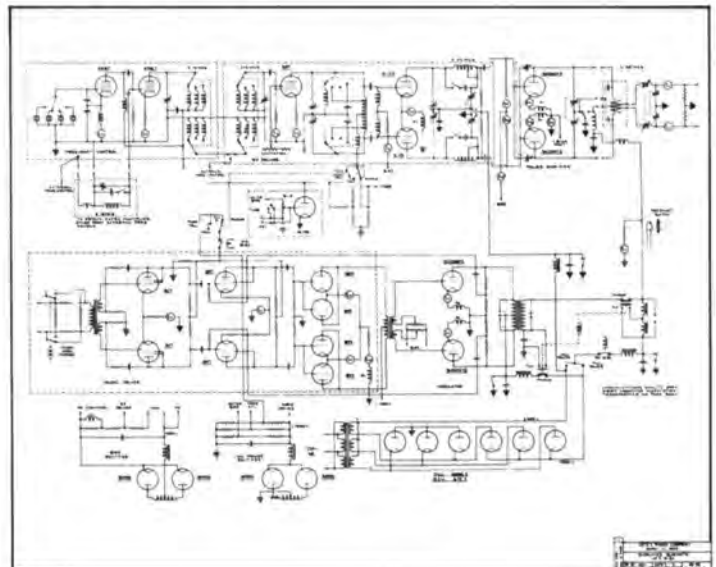

# 10,000 WATT HIGH FREQUENCY TELEGRAPH TRANSMITTER

Model HF-10TX



For telegraphic transmission, Gates offers the HF-10TX electronically keyed, 10,000 watt high frequency telegraph transmitter operating over a frequency range of 2-22 or 4-30 mc. Operated by international radio communication and press services at Tangier, Montevideo, Centerreach, England and other major centers, the HF-10TX is well known for its reliable operation under all kinds of climatic conditions. The HF-10TX is similar in construction to the HF-10B.

## SPECIFICATIONS

- POWER OUTPUT: 10,000 watts.
- OUTPUT IMPEDANCE: 300-800 ohms balanced line. (Other impedances in special line on order.)
- FREQUENCY RANGE: 2-22 mc or 4-30 mc.
- FREQUENCY STABILITY:  $\pm 21$  cycles at 3 mc.
- RF HARMONICS: Suppression of harmonics meets or exceeds FCC requirements.
- POWER SOURCE: 230 volt, 3 phase, 50/60 cycles. (Other voltages and frequencies on special order.)
- TUBES: Oscillator - (1) 6AG7; Buffer-Doubler - (1) 807; Keyer - (1) 811-A; R.F. Driver - (2) 4-125A; PA - (2) 3X2500 F3; Bias Rectifier - (2) 8008; LV Rectifier - (2) 8008; HV Rectifier - (6) 8008; Buffer - (1) 6AG7.
- TOTAL NUMBER TUBES: 18.
- TOTAL TUBE TYPES: 7.

- DIMENSIONS: 125" long, 48 $\frac{1}{2}$ " deep, 78" high.
- NET WEIGHT: 4000 lbs. Export packed, 6500 lbs.
- CUBAGE (export): 450 cu. ft.
- CRYSTAL FREQUENCY: 2-11 mcs or 2-7.5 mcs doubling in frequency control unit with Janes Knight JKO-3.
- CRYSTAL POSITION: 4, external osc. or FSK unit.
- KEYING SPEED: 400 WPM with essential square top wave form. High practical keying speeds up to 600 WPM possible.

## ORDERING INFORMATION

- Model HF-10TX telegraph transmitter, 10,000 watts with complete coil set 2-22 Mc complete set of tubes, less crystals and ovens, but with high speed electronic keyer 60 cys. M-3795  
50 cys. M-3795A
- Spare 100% tube complement for above .....TK-255
- Model HF-5TX, same as above except 5,000 watts output complete coil set 2-22 Mc high speed electronic keyer, complete set of tubes but less crystals and ovens .....60 cys. M-3794  
50 cys. M-3794A
- Spare 100% tube complement for above .....TK-254

# 5000 WATT HIGH FREQUENCY BROADCAST TRANSMITTER

Model HF-5B

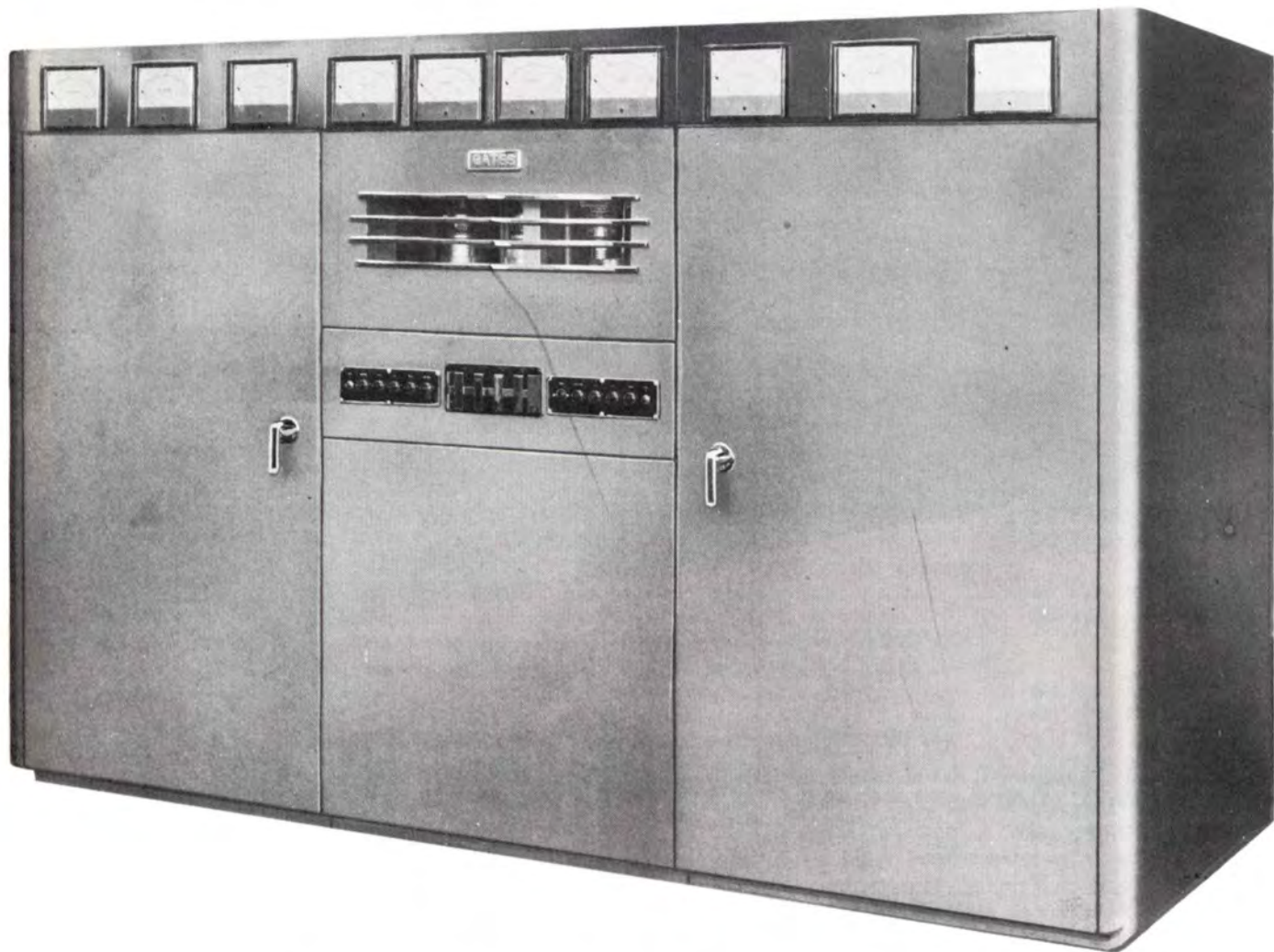

A companion to the HF-10B, the HF-5B 5000 watt high-frequency broadcast transmitter operates at 5000 watts with high level modulation from 2-22 mc. Audio frequency response is uniform within 2 db from 30 to 10,000 cycles. Famous 3X2500F3 tubes with thoriated tungsten filaments are used in both power amplifier and modulator sockets.

A superior transmitter with an excellent global reputation, the HF-5B is rugged, easy to service and gives top performance under rigorous duty in every type of climate.

## HF-5B 5000 WATT HIGH FREQUENCY BROADCAST TRANSMITTER

### SPECIFICATIONS

POWER OUTPUT: Model HF-5 (all models), 5000 watts.  
 OUTPUT IMPEDANCE: 300-800 ohms balanced.  
 FREQUENCY RANGE: 2-22 mc.  
 FREQUENCY STABILITY: .003%.  
 RF HARMONICS: Suppression of harmonics meets or exceeds FCC requirements.  
 AUDIO FREQUENCY RESPONSE: +1.5 db, 30-10,000 cycles broadcast model, +3 db 1500-4000 cycles communications model.  
 AUDIO HARMONIC DISTORTION: 3% or less between 50 and 7500 cycles for broadcast model; 10% or less between frequencies of 150-4000 cycles for communication model.  
 AUDIO INPUT: +14 dbm ± 2 db.  
 AUDIO INPUT IMPEDANCE: 600 ohms normal (multi-impedance input transformer).  
 PRIMARY VOLTAGE: 230 volts, 3 wire, 50/60 cycles, 3 phase.  
 POWER CONSUMPTION AT 100% MODULATION: HF-5B, HF-5BX, HF-5C, HF-5CX, approx. 19.5-KW; HF-5TX, 10-KW.  
 CARRIER SHIFT: 5% or less at 100% modulation.

TUBES (all models): (2) 6AG7, (2) 4-125A, (2) 6J7, (4) 845, (4) 3X2500F3, (10) 8008, (3) 807.  
 TOTAL NO. OF TUBES: 27.  
 TOTAL TUBE TYPES: 7.  
 SIZE: 125" long, 78" high, 49" deep, with door swing front and back doors 40".  
 NET WEIGHT: 8,400 lbs.  
 GROSS WEIGHT:  
     HF-5B with dry type transformers:  
         NET WEIGHT — 6,620 lbs.  
         EXPORT PACKED — 10,220 lbs.  
     HF-5B with oil filled external components:  
         NET WEIGHT — 8,400 lbs.  
         EXPORT PACGED — 12,000 lbs.  
 CUBAGE: 475 cu. ft.  
 FINISH: Medium gray.  
 CRYSTAL POSITIONS: 4.  
 NOISE: 60 db or better below 100% modulation, broadcast model; 45 db or better below 100% modulation, communications model.  
 KEYING SPEED: 400 WPM with square top wave form. Speeds to 600 WPM possible.

### ORDERING INFORMATION

Model HF-5B high frequency broadcast transmitter with complete coil set 2-22 mc, one set of tubes, less crystals and ovens .....	60 cys. M-3786 50 cys. M-3786A
Model HF-5BX, same as above but with electronic keyer added, with tubes complete coil set 2-22 mc, less crystals and ovens .....	60 cys. M-3788 50 cys. M-3788A
Model HF-5C communications telephone transmitter, 5000 watts, with coil set 2-22 mc, one set of tubes but less crystals and ovens .....	60 cys. M-3790 50 cys. M-3790A
Model HF-5CX communications telephone and telegraph transmitter, 5000 watts power, with electronic keyer, complete coil set 2-22 mc, complete set of tubes but less crystals and ovens .....	60 cys. M-3792 50 cys. M-3792A
Model HF-5TX telegraph transmitter only, 5000 watts, with complete coil set 2-22 mc, high speed electronic keyer, complete set of tubes but less crystals and ovens .....	60 cys. M-3794 50 cys. M-3794A
Crystal and oven ready to use with any of above transmitters.	
Specify carrier frequency desired when ordering (HFXT-1) .....	M-3796
Complete 100% tube set for 5-KW telephone models (HFTSB-5) .....	TK-252
Complete 100% tube set for 5-KW telegraph models (HF-TXB-5) .....	TK-254
Tube set for electronic keyer .....	HFK

# 1,000 WATT HIGH FREQUENCY BROADCAST TRANSMITTER

Model HF-1M

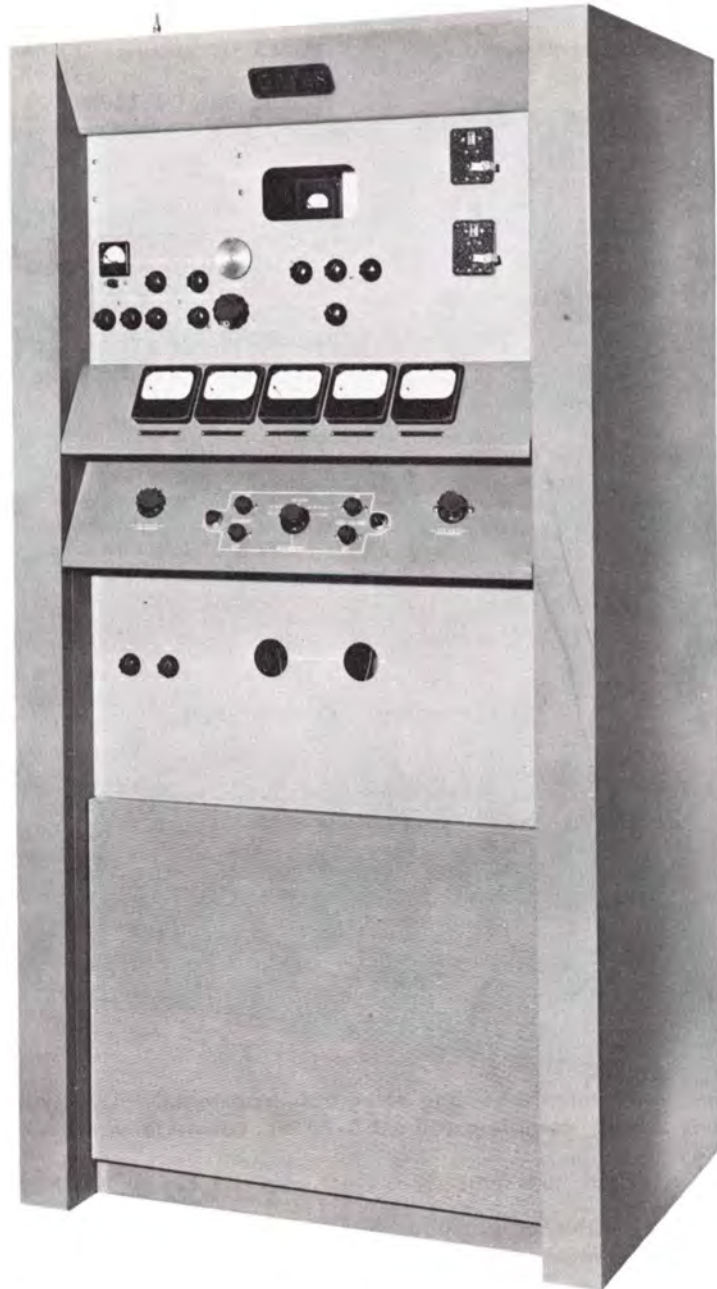

The HF-1M Transmitter supplies 1000 watts output power that may be 100% modulated for either communications or broadcast. Powers in excess of 1KW output are possible when keyed. With high frequency coverage from 2 & 32 mc, coverage between 3 & 32 mc is continuously variable from the front panel, by adjusting dial settings — no component changes necessary. HF-1M is an all purpose transmitter. All modulation components are of broadcast quality. Where the wide audio range of broadcasting is not desired, the Gates limiter/filter amplifier is added

for communication quality. Manual keying up to 60 WPM including break-in may be augmented with an optional electronic keyer for speeds up to 400 WPM.

Heart of the HF-1M is the M-5239 exciter that accommodates 10 crystals in open holders (0.02% accuracy) or in temperature controlled ovens (.003% accuracy). Completely self-contained including metering, this exciter delivers up to 85 W output to drive the final power amplifier directly. Entire tune-up of the transmitter to the

## HF-1M 1,000 WATT HIGH FREQUENCY BROADCAST TRANSMITTER

final stage is simple and quick. Select desired crystal frequency, set band change controls to proper frequency range and resonate. Logging for resonance is restricted to only two controls as oscillator is untuned. Has three stages: 5763 oscillator, 5763 amp. doubler and (2) 6146 output. A 6AQ5 screen clamper and OB2 regulator tube is also employed. Keying or break-in is optional three ways: (1) oscillator cathode only, (2) IPA cathode only, or (3) both.

Continuously variable rotating coils ganged for one dial operation, tune the PA stage from 3-32 mc. Where operation is below 3 Mc a padder is added. For quicker tuning a low power tune-up switch has been incorporated to allow the operator to check exact resonance before applying full power. The HF-1M uses a single 4-1000A power tube in the final amplifier. This tube rating is actually capable of over 1500 watts output which means long life at 1000 watts.

### OUTSTANDING FEATURES

1. Continuously variable by front panel control 3-32 mc, a padder is added where 2 mc is desired.
2. Audio system either for broadcast or voice. When voice only, use with M-5263 limiter/filter amplifier.
3. Complete relay system for complete protection including (a) fil. on relay, (b) plate on relay, (c) time delay relay, (d) PA overload relay, (e) mod. overload relay and (f) underdrive relay.
4. High level class B modulation with twin-drive audio for full reliability, low distortion and long tube life with 833A modulators.
5. 230 volt, 50 or 60 cycles, single phase operation. Main power supply has 2-section choke filter for superior regulation and low ripple content.
6. Servicing ease and maintenance. Only one cable interconnects the entire transmitter. RF and audio decks instantly removable to clean or service. Blower and suction fan assures excellent cooling of all components.

REAR VIEW

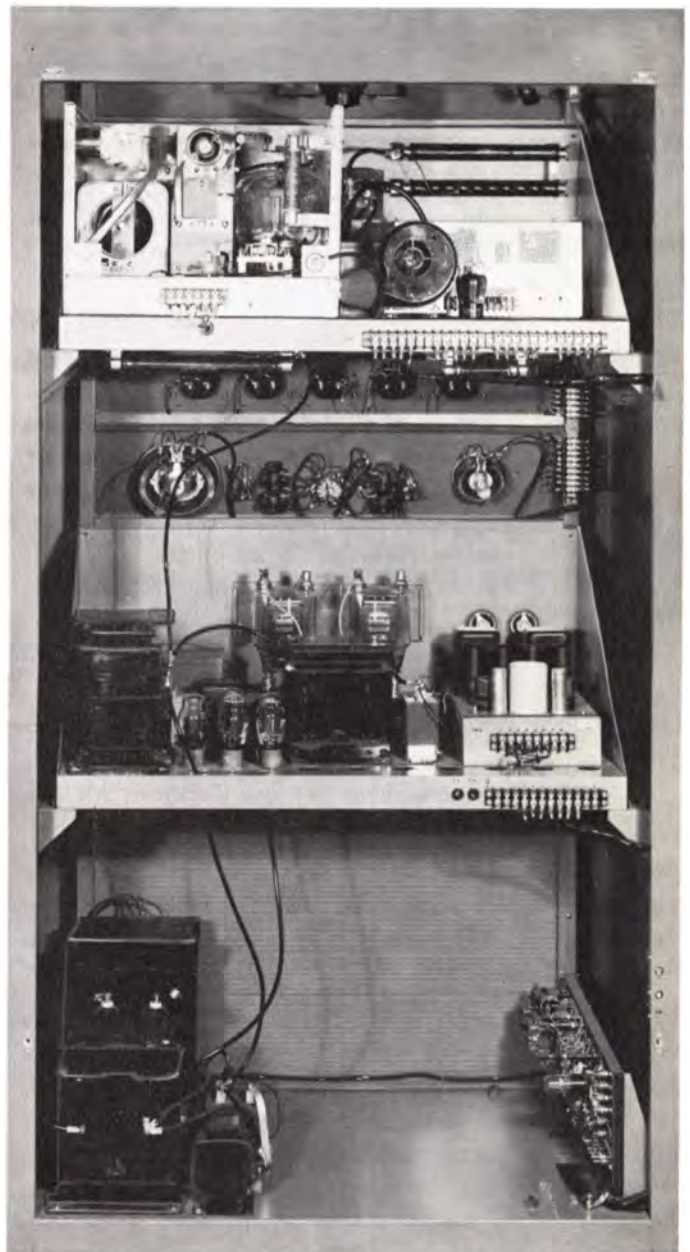



# HF-1M 1,000 WATT HIGH FREQUENCY BROADCAST TRANSMITTER

## SPECIFICATIONS

**POWER OUTPUT:** 1000 watts, 100% modulated, 2-26 mc. 800 watts, 100% modulated, 26-32 mc.

**RF OUTPUT IMPEDANCE:** 51.5 ohms. Where other output impedances are desired, special coupling units are available to match customer requirements.

**RF RANGE:** 2-32 mc. Continuously variable by front panel tuning. Padder added for 2 mc operation.

**RF STABILITY:** Where used with JKO-2 temp. controlled oven, .003%. Where used with H-7 holder. 0.02%.

**RF HARMONICS:** Suppression of harmonics meets or exceeds FCC requirements.

**AUDIO FREQUENCY RESPONSE:** As broadcast transmitter  $\pm 2$  db 50-7500 cycles.  $\pm 2\frac{1}{2}$  db 30-10,000 cycles. As communications transmitter (when used with M-5263 limiter/filter amplifier)  $\pm 2\frac{1}{2}$  db 200-2500 cycles with sharp cut-off above 2500 cycles.

**AUDIO HARMONIC DISTORTION:**  $3\frac{1}{2}\%$  or less 50-7500 cycles at 95% modulation.

**AUDIO INPUT:** 10 db  $\pm 2$  db as broadcast transmitter. When used with M-5263 limiter/filter amplifier, input is for either low level microphone or 600 ohm line.

**AUDIO INPUT IMPEDANCE:** 150, 250 or 600 ohms.

**PRIMARY VOLTAGE:** 230 volts single phase 50/60 cycles.

**POWER CONSUMPTION:** Consumption at 0% modulation or CW, 3200 W. At average modulation, 4500 W.

**CARRIER SHIFT:** 3% or less at 100% modulation.

**TUBES:** (Radio frequency) 5763 osc., 5763 amp. doubler, (2) 6146 drivers, 4-1000A power amplifier, OB2 regulator (2) 6Y6G clampers (audio), (2) 6SN7 input, (4) 1622/6L6G drivers (2) 833A modulators. Power supplies (4) 5R4GY, (2) 8008, (1) 6AQ5 clamper.

**TOTAL NUMBER OF TUBES:** 23.

**TOTAL TUBE TYPES:** 10.

**TYPE OF OUTPUT:** Single ended, full Tee network.

**NUMBER OF CRYSTALS:** Ten crystal positions. Where JKO-2 temperature controlled oven is used, 2 crystals used in each oven. For non-temperature controlled crystals, up to ten type H-7 crystals and holders may be accommodated. Crystal switching from front panel.

**MODULATION:** High level Class B.

**WEIGHT:** 1095 lbs. packed, 846 lbs. net. Cubage 97. Export weight 1665 packed. Export cubage, 158.0.

**COOLING:** Squirrel cage blower cools final power tube and PA. Fan in ceiling of transmitter complete circulation thru grill intake at bottom front.

## ORDERING INFORMATION

Model HF-1M High Frequency Transmitter complete w/one set tubes, less crystals .....	M-4964
100% spare tube complement for above .....	TK-259
Crystal and holder for 0.02% accuracy* .....	H-7
Crystal and holder for 0.003% accuracy (mounts in JKO-2 oven)** .....	H-17
Temperature controlled oven (holds one or two H-17) .....	JKO-2
Limiter/Filter audio amplifier .....	M-5263
Exciter only .....	M-5239

\* State frequency when ordering.

\*\* State frequency when ordering. Use only with JKO-2 oven.

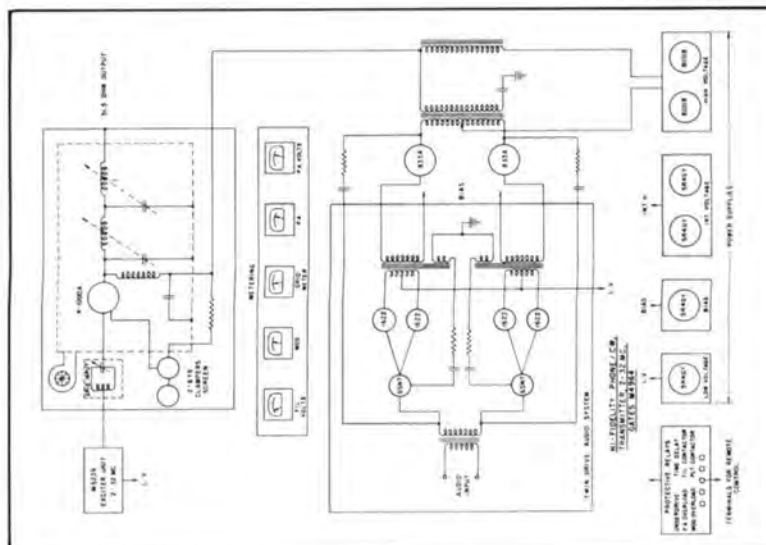

# 250 WATT HIGH FREQUENCY TRANSMITTER

## Model CMG-1



The CMG-1 250 watt high frequency transmitter is used for telephone and telegraph operation and is continually variable between 2-32 mc, with high level modulation. The CMG-1 may be quickly changed in frequency from the front panel.\* Four crystal inputs, audio system for microphone or line, 3000 cycle cut-off filter, peak limiting amplifier to prevent over-modulation and small over-all size, make the CMG-1 attractive for many commercial uses.

**GENERAL DESIGN:** Construction is on 3 rugged chassis that mount into the transmitter cabinet and join together with a preformed cable. As each chassis is quickly removable, servicing is greatly enhanced. Top chassis is a com-

plete radio frequency unit with output coupling network. Center chassis is the modulator. Bottom chassis is the main power supply.\*\*

**RF CHASSIS:** 3 stages with two 4/65A power amplifiers produce a full 250 watts carrier at any frequency between 2-26 mc. Provision is made for 4 crystals which mount (2 per oven) in a JKO-2 temperature controlled oven for .003% or better stability. There are no plug-in coils or relays to effect frequency change. Dial and veeeder counter indicators allow accurate logging for quick frequency change. Output is a Pi-network allowing a wide variety of impedance matching.

**MODULATOR:** Includes microphone amplifier with push-to-talk facilities, line input of 500 ohms, peak limiter allowing compression of as much as 25 db with excellent intelligibility, 3000 cycle cutoff filter and high level Class B 811A tubes assure 100% modulation at all times.

**POWER SUPPLIES:** Two provided. Main supply is full wave 866A tubes well filtered. Plate and bias voltage for low stages are supplied by a full wave system with a 5V4 rectifier.

**METERING:** Four meters include: (1) PA current, (2) plate voltage, (3) RF output, and (4) multimeter for oscillator plate, IPA grid, IPA plate, PA grid and modulator currents.

**RELAY CIRCUITS:** Standard equipment includes; (1) push-to-talk, (2) receiver muting, (3) vacuum time delay, (4) PA overload, and (5) modulator overload.

**CONTROLS:** Filament start switch, plate start switch, overload front panel reset audio gain, PA plate tune, antenna loading, oscillator resonance, IPA resonance, and PA excitation.

**OPTIONAL FILTERS:** Though harmonic reduction of the CMG-1 transmitter is excellent, in extreme cases of close proximity to other services an additional second harmonic filter may be desired. For certain services within the United States it is necessary to install a special low pass filter. These filters will be quoted according to customers exact need.

## CMG-1 250 WATT HIGH FREQUENCY TRANSMITTER

### SPECIFICATIONS

**POWER OUTPUT:** 250 watts to 26 mc, 200-225 watts up to 32 mc.  
**RF OUTPUT IMPEDANCE:** 40-300 ohms.  
**RF RANGE:** 2-32 mc continuously variable.  
**FREQUENCY STABILITY:** When used as above, 0.003%.  
**RF HARMONICS:** Suppression of harmonics meets or exceeds FCC requirements.  
**AUDIO FREQUENCY RESPONSE:**  $\pm 2$  db 200-3000 cycles with sharp cut-off above 3000 cycles.  
**AUDIO HARMONIC DISTORTION:** Less than 8% at all frequencies 200-3000 cycles, 100% modulation.  
**AUDIO INPUT:** Hi-Z for microphone at -55 db input. 600 ohms at 0 dbm input level.  
**PRIMARY VOLTAGE:** 115 volts, 50/60 cycles.  
**POWER CONSUMPTION:** 900 watts at zero modulation, 1000 watts at average modulation, 1250 watts at 100% modulation.

**CARRIER SHIFT:** 5% or less at 100% modulation.  
**TUBES:** 6AG7 oscillator; 6146 IPA; two 4/65A; two 866/866A rectifiers; one 6Y6; two 6C5; one VR-150; 6SJ7 mic amplifier; 6L7 second amplifier and line input; 6L6 driver; two PP 811A modulators; 6H 6 limiter tube and two 5U4G modulator rectifiers.  
**TOTAL NUMBER OF TUBES:** 18.  
**TOTAL TUBE TYPES:** 13.  
**SIZE:** 50" high, 23" wide, 26" deep. Door swing 20".  
**ESTIMATED WEIGHT:** 550 lbs. packed. Export packed, 720 lbs.  
**EXPORT CUBAGE:** 53.8.  
**FINISH:** Medium gray.  
**MODULATION:** High level Class B.  
**KEYING SPEED:** 60 WPM.  
**NUMBER OF CRYSTALS:** Maximum of four (Type H-17 in JKO-2 oven).  
**VFO INPUT:** Provided on receptacle rear terminal board of transmitter.

### ORDERING INFORMATION

Model CMG-1 telephone and telegraph transmitter with tubes, less crystals .....	M-4575
Crystal in holder (less oven) for 0.02% accuracy .....	H-7
Crystal in holder for .003% accuracy .....	H-17
Oven to accommodate two H17 crystals .....	JKO2
100% spare tube complement .....	TK136
Microphone assembly complete .....	M-4576
<b>Filters for added second harmonic attenuation:</b>	
For 50 ohms .....	M-4775
For 72 ohms .....	M-4776
For 250 ohms .....	M-4777

This model approved by the Federal Civil Defense Administration.

**NOTE:** Be sure to state crystal frequency when ordering.

\* Except between 2-3 mc where one internal link is disconnected.

\*\* The CMG-1 can be modified for transportable service in truck or trailer.

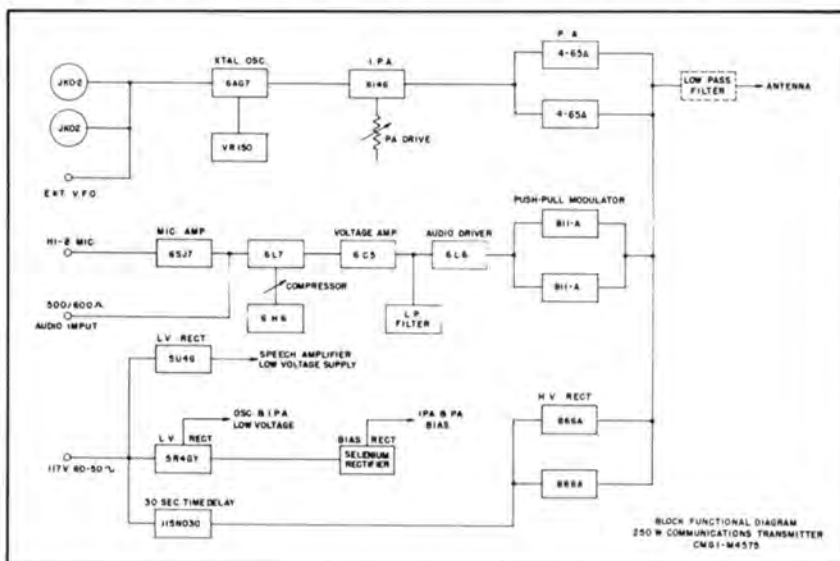

# 1000-WATT INPUT TELEGRAPH TRANSMITTER

Model CMP-1

- Specifically for police band from 2805-7935 Kc but models available for 2-10 Mc.
- High speed electronic keying.
- Multi plug-in oscillators for quick frequency change.
- Remote control as optional accessory.
- Heavy design for 24-hour, day-in and day-out service.
- Designed for ease of maintenance and servicing.

This 1000 watt high speed telegraph transmitter is designed specifically for police service where three closely associated crystal frequencies are employed, such as 2804, 2808 and 2812 — a typical police band. Its design, however, is adaptable to any frequency between 2-10 Mc, and is for use where a highly reliable, heavy duty, high speed telegraph transmitter is required.

**GENERAL DESIGN:** Transmitter is completely constructed in one cabinet 78" high, 28 $\frac{1}{2}$ " wide, 32" deep, with full size back door, forced air cooling of power tubes, convex cooling of transmitting plant with filtered air intake. Sides of cabinet are removable and cabinet design is such that all front panel controls are inset to prevent brushing control accidentally when walking by. Finish is in dark gloss gray for easy cleaning.

**OSCILLATORS:** Three provided, each having a temperature controlled oven operating from self-contained transformer of the self-tuned type, selectable into the transmitter by relays. Push-button control oscillators removed from front for either servicing or if for any reason it is desired to change frequency. Design of oscillator is for extreme accuracy and impervious to fall-out.

**INTERMEDIATE AMPLIFIERS:** The output of the oscillators is fed into a 6AG7 doubler stage, self-neutralized. The doubler and oscillator are electronically keyed (see keyer). The second intermediate amplifier is a 4-65A, self-neutralized. The use of three RF stages prior to the power amplifier is complementary to a square wave form during keying. Prevents possibility of an interaction between the power amplifier and oscillator plus assuring an abundance of driving power to the final amplifier under all conditions.

**POWER AMPLIFIER:** Consists of two 4-400A tubes, self-neutralized and in parallel operation. Tubes are forced air cooled through a blower mounted directly to the air duct/tube socket assembly. An air pressure control switch is part of this assembly for full tube protection in case of blower failure. Output coupling provides unusually good harmonic attenuation. This is a parallel resonant tank circuit into an L section which develops a pi-network. Because of this type of circuit, the purchaser should stipulate the RF output impedance desired when ordering. Standard output impedance 51.5 ohms. An external low-pass filter is used for harmonic reduction.

**KEYER:** Electronic keying, which operates in the plate circuit of the oscillator/first IPA — doubler stage, employs the principle of biasing an 811A tube where with the key closed, no current is drawn. Though keying up to 100 WPM is recommended, higher speeds are not unusual. This transmitter may also be adapted to frequency shift keying and will be so supplied when stated on the

order. Frequency shift keyers are listed elsewhere in this catalog (see Index).

**METERING:** Nine meters are standard equipment, reading all major circuits.

**PROTECTIVE DEVICES:** Include PA overload relay, bias under voltage relay, time delay relay, filament start relay, plate start relay, air pressure switch of diaphragm type, and all necessary interlocks.

**POWER SUPPLIES:** Five are supplied including main high voltage, full wave rectifier, low voltage bias supply, low voltage selenium supply for relay/remote operation, plus screen supply.



## CMP-1 1000-WATT INPUT TELEGRAPH TRANSMITTER

### SPECIFICATIONS

**FREQUENCY RANGE:** Specifically designed for 2-8 Mc police frequencies but available on order for any frequency up to 10 Mc.

**OSCILLATORS:** Three supplied to frequency as ordered.

**POWER INPUT:** 1000 watts.

**INPUT VOLTAGE:** 230 volts, 3-wire, single phase, 50/60 cycles.

**KEYING:** Electronic 100 WPM or less.

**FREQUENCY SHIFT KEYING:** Optional provision when ordered. FSK not part of transmitter (see FC keyers—Index).

**SIZE:** 78" high, 28½" wide, 32" deep.

**FINISH:** Dark gloss gray.

**TUBES:** Three 6AG7 oscillators, one 6AG7 Doubler, one 4/65A RF driver, two 4/400A RF amplifier, one 6B4G keyer, two 8008, high voltage rectifier, one 5U4G low voltage rectifier, one 5U4G bias rectifier, one 5U4G screen rectifier.

**RF OUTPUT IMPEDANCE:** 51.5 ohms.

**RF STABILITY:** 0.003% or better.

**LOGGING:** Veeder counter controls on all variable controls to one-tenth turn. Accurate dial controls on other variable units for any pre-set logging of frequency.

**WEIGHT:** Export packed, 1100 lbs. Export cube, 90.0.

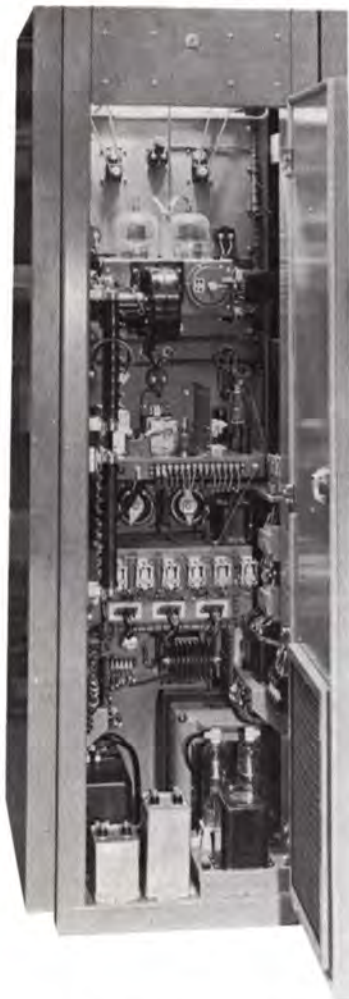

Transmitter accommodates three oscillators of plug-in type which slide into the front of the transmitter, as illustrated above. Each oscillator completely self-contained other than power supply. Provided with temperature controlled crystal holder for 0.003% accuracy. Changing oscillators is accomplished through three relays, push-button operated from transmitter control, or optional remote control.



Remote control panel for use with CMP-1 transmitter where transmitter is remotely controlled from a control desk either adjacent or several hundred feet distant. Mounted on standard 19"x5¼" rack panel. Includes plate On-Off switch, keying facility, pilot lights indicating filament and plate On, and push-button for selection of operating frequencies.

### ORDERING INFORMATION

- Complete transmitter for operation on 2804, 2808, and 2812 Kc, with tubes, less crystals ..... **CMP-1**
- Complete transmitter for operation on 5135, 5140 and 5195 Kc, with tubes, less crystals ..... **CMP-1A**
- Complete transmitter for operation on 7480, 7805 and 7935 Kc, with tubes, less crystals ..... **CMP-1B**
- Complete transmitter for operation on any closely associated frequencies not stated above up to 10 Mc, with tubes, less crystals .... **CMP-1D**
- Remote control panel, rack mount, two transmitters ..... **CON-2**
- Remote control panel, rack mount, three transmitters ..... **CON-3**
- 100% spare tube complement for above transmitters ..... **TK-138**

This model approved by the Federal Civil Defense Administration.

NOTE: Be sure to specify frequency of operation and transmission line impedance when ordering.

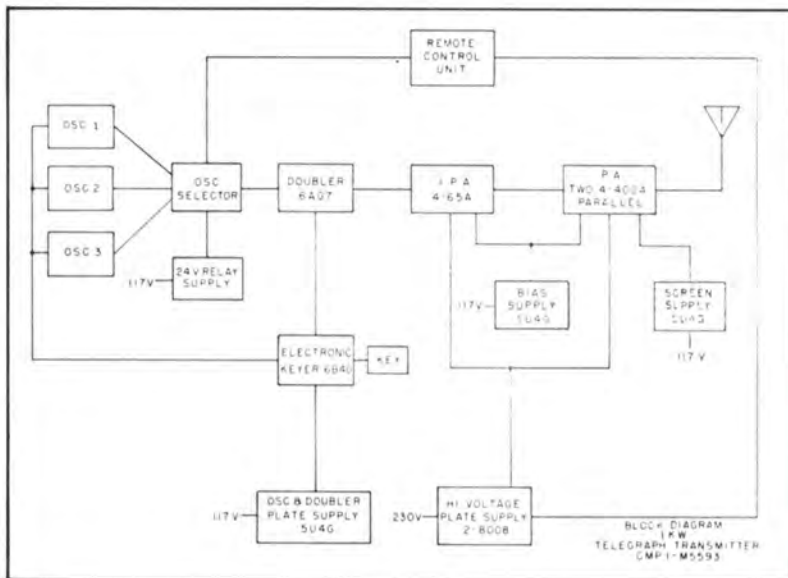

# TWO CHANNEL PHONE CW 250 WATTS OUTPUT

Model M-3449Y

A complete telephone and telegraph transmitter with two radio frequency channels providing instantaneous changeover and therefore multi-band operation on two frequencies. Additional frequencies from 2-22 Mc may be accommodated by use of the plug-in coils sets listed below.

Looking at the transmitter illustrations at the right from top to bottom are the following units completely inter-wired and ready to use:

- Dual channel antenna coupling unit, M-3451Y
- Meter panel, M-3460Y
- Radio frequency unit, M-3452Y
- Control panel, M-3461Y
- Modulator unit, M-3453Y
- Power supply unit, M-3454Y

Constructed in 84" rack cabinet, completely wired and ready to use.

## SPECIFICATIONS

- FREQUENCY RANGE:** 2-22 Mc by coil selection.
- FREQUENCY STABILITY:** 0.003% when used with JKO-2 oven or 0.02% when used with H7 crystal and holder.
- MODULATION:** High level Class B with self-contained peak limiting amplifier and 3000 cycle cutoff filter.
- POWER OUTPUT:** 250 watts telephone and telegraph.
- POWER INPUT:** 115 volts, 50/60 cycles.
- AF INPUT:** Hi-Z for microphone and 600 ohms for line. Push-to-talk facilities for transmitter On-Off and receiver muting provided.
- RF OUTPUT:** 2 channels, each 20-300 ohms.
- SHIPPING WEIGHT:** Export packed, 905 lbs. Export cubage, 78.7.

## ORDERING INFORMATION

- Two channel telephone and telegraph transmitter with one set of tubes, less crystals ..... M-3449Y
- Spare 100% tube complement ..... TK-222
- Plug-in coil sets: For 2-3 Mc ..... M-3641
  - For 3-4.2 Mc ..... M-3642
  - For 4-7.2 Mc ..... M-3643
  - For 7-13 Mc ..... M-3644
  - For 12-33 Mc ..... M-3645
- Crystal and holder for 0.02% accuracy ..... H-7
- Crystal and holder for use in JKO-2 oven (listed below) 0.003% accuracy ..... H-17
- Temperature controlled oven only for mounting two H-17 crystals ..... JKO-2
- Complete push-to-talk microphone assembly ..... M-4237

**NOTE:** Be sure to specify crystal frequency when ordering. (For 2-11 Mc operation, crystals on frequency. 11-22 Mc, crystals 1/2 operating frequency.)

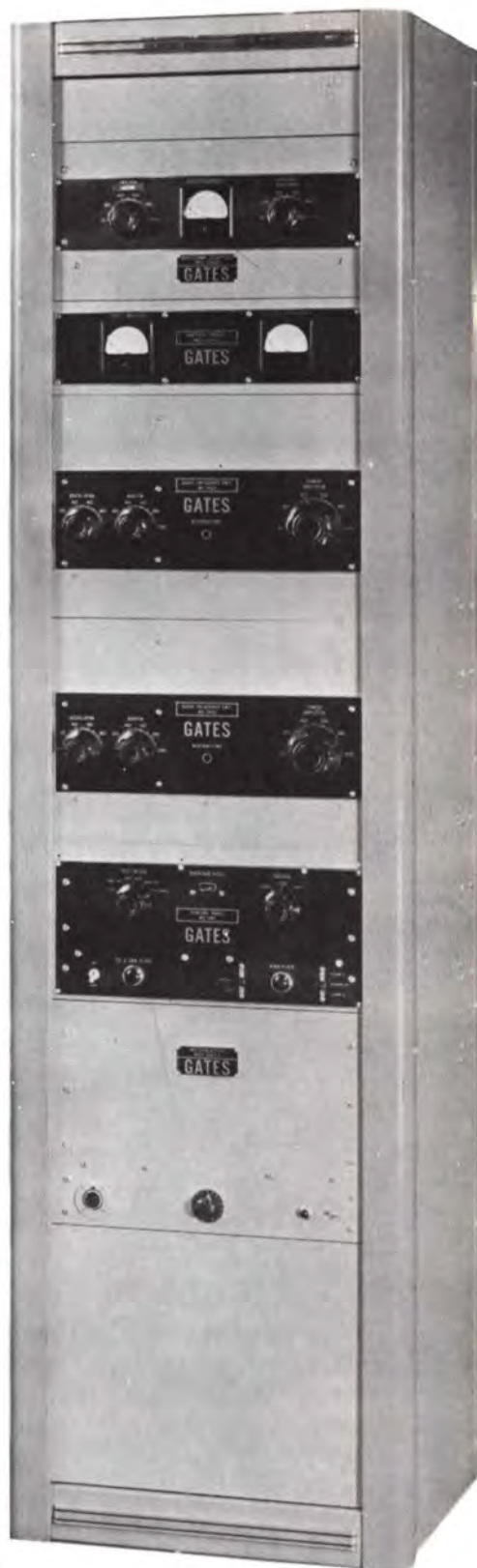

# SINGLE CHANNEL PHONE CW 250 WATTS OUTPUT

Model M-3491

Perhaps the majority of radio telephone and telegraph services operate on one channel only. This transmitter provides single frequency operation on any frequency between 2-22 Mc simply by selecting the proper coil set listed at the bottom of the page and the correct crystal. By referring to the illustration at the right, the following units comprising a complete transmitter are installed and inter-wired, ready for use.

- Single channel antenna coupling unit, M-4239
- Meter panel, M-3460Y
- Radio frequency unit, M-3452Y
- Control panel, M-3461Y
- Modulator unit, M-3453Y
- Power supply unit, M-3454Y

Equipment is mounted in a rack cabinet standing 68" high. May be used with M-4237 microphone assembly and choice of crystals for either 0.02% or 0.003% accuracy.

## SPECIFICATIONS

- FREQUENCY RANGE:** 2-22 Mc by coil selection.
- FREQUENCY STABILITY:** 0.003% when used with JKO-2 oven, or 0.02% when used with H7 crystal and holder.
- MODULATION:** High level Class B with self-contained peak limiting amplifier and 3000 cycle cutoff filter.
- POWER OUTPUT:** 250 watts telephone and telegraph.
- AF INPUT:** Hi-Z for microphone and 600 ohms for line. Push-to-talk facilities for transmitter On-Off and receiver muting provided.
- RF OUTPUT:** Single channel, 20-300 ohms.

## ORDERING INFORMATION

- Single channel telephone and telegraph transmitter with one set of tubes, less crystals ..... M-3491Y
- Spare 100% tube complement ..... TK-237
- Plug-in coil sets: For 2-3 Mc ..... M-3641
- For 3-4.2 Mc ..... M-3642
- For 4-7.2 Mc ..... M-3643
- For 7-13 Mc ..... M-3644
- For 12-22 Mc ..... M-3645
- Crystal and holder for 0.02% accuracy ..... H-7
- Crystal and holder for use in JKO-2 oven (listed below), 0.003% accuracy ..... H-17
- Temperature controlled oven only for mounting H-17 crystals ..... JKO-2
- Complete push-to-talk microphone assembly ..... M-4237

**NOTE:** Be sure to specify crystal frequency when ordering. (For 2-11 Mc operation, crystals on frequency. 11-22 Mc, crystals 1/2 operating frequency.)



# CMW-1 2-22 MC TRANSMITTER

(700 Watts Input, Telephone and Telegraph)

**RADIO FREQUENCY** section is constructed in two sections, mounted one above the other. Two crystals, either in open or a temperature controlled oven, are switch selectable into a 6AG7 Colpitt oscillator. Added crystals may be plugged in. The 4-65A IPA provides abundant drive to the final class C amplifier, consisting of pushpull 100TH tubes link coupled to the IPA stage. The PA section is 100% shielded for stability and low spurious radiation. Frequency range is covered by five sets of plug-in coils to extend continuously over the entire 2-22 Mc range.

**MODULATOR**-audio section is complete in every detail. Input accommodates both a low level dynamic microphone with push-to-talk switch and 600 ohm line. Limiter permits 100% modulation without over-modulation and allowing much higher average voice level, equivalent to greater power output. A 3000 cycle filter sharply cuts off all audio response above 3000 cycles. Modulators are Class B 100TH tubes interchangeable with the RF power tubes. Power supply for all but the modulators is self contained on the modulator deck.

**METERING** of all needed circuits is accomplished with four meters: (1) PA plate current, (2) modulator current, (3) antenna or line current, and (4) a multi-meter switch selectable to grid and plate circuits of the measurable radio frequency stages.

**POWER SUPPLIES** include main high voltage supply with dual 8008 tubes, LV audio supply and modulator bias supply.

**RELAY CONTROL** is an outstanding CMW-1 feature. Relay complement totals 8 in all. These are: (a) time delay, (b) plate on contactor, (c) RF overload, (d) phone/CW relay, (e) keying relay, (f) transmit-receive antenna changeover relay, (g) Channel 1 relay, and (h) Channel 2 relay. Though the CMW-1 transmitter, as supplied, has one RF channel, provision for changeover to a second RF channel is incorporated.

**LOCAL REMOTE CONTROL** provision is made by providing terminal connections for remote operation of: (a) plate on, (b) phone on, (c) channel on, (d) filament on light, and (e) plate on light.

**ANTENNA COUPLER** assures matching over-impedance ranges from 30 to 600 ohms with either a "Tee," "L" or "Pi" network. Where desired, the output may be coupled directly to the PA output link having an impedance of about 50 ohms. Fixed and variable capacitors are circuit arranged into a tapered coil. An O-5 RF ammeter is part of the antenna coupler. The changeover relay is located near the coupler at the top of the cabinet.

**MICROPHONE** is optional equipment and the M4576 dynamic microphone with push-to-talk desk stand is recommended for this equipment.

**KEYING** is in the oscillator cathode. A keying relay is provided and speeds up to 60 WPM are possible.

**PERFORMANCE:** The CMW-1 transmitter rated at 700 watts input is indeed conservative. The experienced engineer will quickly note the much higher power capabilities of the 100th tubes. With limiter and filter in the audio system, high levels of average modulation with no concern of sideband splash greatly increase the effectiveness. In no place has other than the finest of materials been employed. Generous RF driving power indicates ease of modulation at all frequencies. Link coupling between the IPA and power amplifiers and between the PA tank and antenna coupler adds greatly to stability and quick reliable tune-up.





## CMW-1 2-22 MC TRANSMITTER

### SPECIFICATIONS

**FREQUENCY RANGE:** 2-22 Mc.  
**FREQUENCY STABILITY:** Where used with JK02 temperature controlled oven (2 crystals in one oven), stability is .003%. Where used with H-7 holder, stability is .02%.  
**POWER INPUT:** Rated at 700 watts all frequencies.  
**MODULATION:** High level Class B.  
**AUDIO RESPONSE:** 150-3000 cycles  $\pm 2\frac{1}{2}$  db. Sharp cut-off above 3000 cycles.  
**AUDIO DISTORTION:** 8% or less 150-3000 cycles.  
**NOISE:** 45 db or better below 100% modulation.  
**MICROPHONE INPUT:** Hi-Z for either dynamic or crystal microphone.  
**LINE INPUT:** 600 ohms.  
**KEYING SPEED:** 60 WPM.  
**RF OUTPUT IMPEDANCE:** 30-600 ohms unbalanced or 50/70 ohms balanced.  
**POWER INPUT:** 115 volts, 50/60 cycles. Carrier off, 575 watts; carrier on (0 modulation),

**POWER INPUT:** 1610 watts; at average modulation, 1875 watts, and at 95% modulation, 2175 watts.  
**SIZE:** 84" high, 23" wide, 18" deep. Door swing 20".  
**FINISH:** Medium gloss gray panels. Dark gray cabinet.  
**WEIGHT:** Net 500 lbs. Packed 770 lbs.  
**CUBAGE:** 28.  
**TUBES:** Oscillators, 6AG7.  
 Int. Power Amplifier, 4-65A.  
 Power Amplifier, (2) 100TH.  
 1st Audio, 6SJ7.  
 2nd Audio, 6L7.  
 3rd Audio, 6C5.  
 4th Audio, (2) 6L6.  
 Modulator, (2) 100TH.  
 Limiter Tube, 6H6.  
 Phase Inverter, 6SN7.  
 Rectifiers, 5V4G, 5R4GY, 5U4G, (2) 800B.  
 Voltage Regulator, OD3/VR150.

### ORDERING INFORMATION

**CMW-1 transmitter complete with tubes, coil sets for 2-22 Mc, less microphone and crystals** ..... **M-4311B**  
**Microphone with push-to-talk desk stand, 7' cable and plug** ..... **M-4576B**  
**Spare 100% tube complement** ..... **TK137**  
**Crystal and holder for .02% accuracy\*** ..... **H-7**  
**Temperature controlled oven for two H-7 crystals** ..... **JK02**

\* State frequency desired when ordering.

**NOTE:** This model approved by Federal Civil Defense Administration.

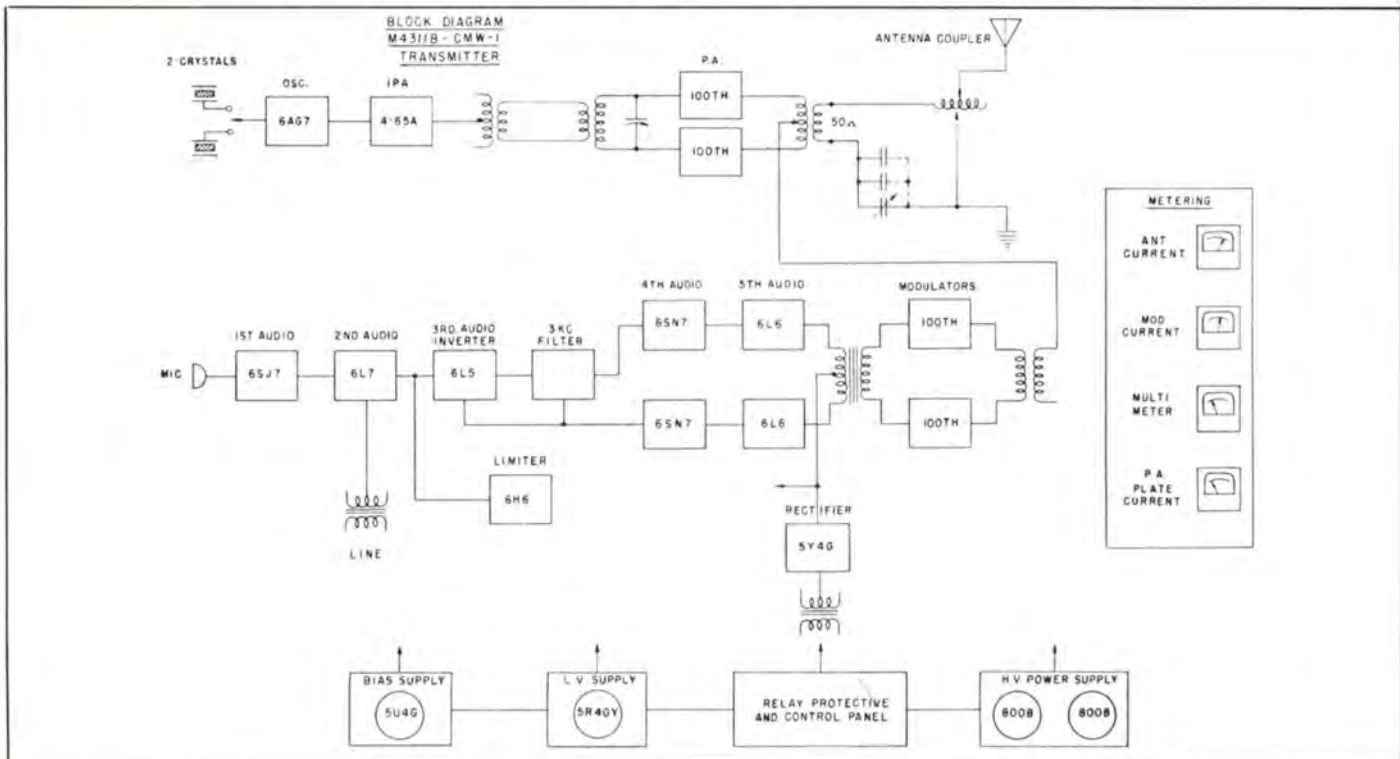

# 65/85 WATT TRANSMITTER OR EXCITER



## SPECIFICATIONS

(65/85 Watt Transmitter)

**FREQUENCY RANGE:** 2-32 Mc continuously variable from front panel.

**POWER INPUT:** 85 watts CW or 65 watts high level modulated.

**OUTPUT IMPEDANCE:** 30 to 300 ohms unbalanced.

**CRYSTAL INPUT:** 10 Type H-17 which may be mounted in five Type JKO2 temperature controlled ovens (2 crystals to an oven) for .003% accuracy or when not mounted in oven, 0.02% accuracy. Crystals selected from front by switch.

**KEYING:** Electronic differential keying permitting fast break-in operation. May be left on standby (key up) for long periods without detriment. Keying speed 60 WPM. When used with modulator, push-to-talk circuit operates same as keying.

**TUNING CONTROLS:** Crystal switch, oscillator tune, oscillator band switch, buffer tune, buffer band switch, PA tank frequency, PA tune, output loading.

**OPERATION CONTROLS:** Meter Switch, excitation, operation switch, key jack, On-Off switch and fuse.

**TUBES:** 5763 osc., 5763 IPA, (2) 6146 power amplifiers, OB2 screen switch tube, 6AQ5 screen clamper, 12AU7 keyer tube, 6AL5 bias rectifier, (2) 5R4GYA rectifier.

**AC POWER:** 115 volts, 50/60 cycles, 175 watts.

**SIZE:** For rack mount — 19" wide, 10½" high and 14½" deep. In cabinet (as illustrated) — 20½" wide, 12" high and 15" deep.

A carefully engineered precision RF unit having a wide variety of applications. Designed strictly for commercial applications and tunes all frequencies continuously variable, between 2 and 32 megacycles. When used with the M5570 amplifier modulator, described immediately following, an excellent 65 watt (power input) telephone transmitter, meeting full FCC specifications, is had. As a CW transmitter, this unit is complete to matching a wide variety of output impedances and self-contained power supply. For use as a dependable exciter for higher powered transmitters, there is ample power output to drive many variations of RF power amplifiers without the need for an RF driver stage.

A ten crystal, front panel, removable oscillator unit accommodates either temperature controlled ovens or non-temperature controlled crystal holders. Calibrated dials and a counter type dial on the final variable tank coil assure excellent logging for tuning by non-technical personnel. A single meter, switch selected, indicates oscillator, IPA, PA grid and PA plate current. — Frequency multiplication is accomplished in the oscillator with the advantage of low frequency crystals not exceeding 8 Mc, used for all output frequencies up to 32 Mc. A further advantage of the IPA stage always operating at the same frequency as the power amplifier stage adds to stability and ease in initial tune-up and future logging.

Either rack or desk cabinet mounting may be employed. The modest size of 10½" by 19" of rack space indicates a generous amount of engineering time in the design.

## ORDERING INFORMATION

Complete CW transmitter with tubes .....M-5569

100% spare tube kit for above ..... TK-291

Crystal and holder for 0.02% accuracy ..... H-17

Temperature controlled oven to hold two Type H-17 crystals and holders for .003% accuracy .....JKO2

NOTE: Please state carrier frequency desired when ordering crystals. For complete telegraph and telephone transmitters, see subsequent pages, Model CM-65.

# MODULATOR/AMPLIFIER FOR 65 WATT TRANSMITTER

Designed as a companion unit for M-5569 transmitter shown above. Has four stages with low-pass filter and peak limiting amplifier to meet full FCC specifications. Meter switch selects to read either compression or modulator swing. Front panel equipment includes microphone receptacle, compressor setting, gain control, fuse, phone-CW switch, filament switch with pilot light and plate switch with pilot light. Push-to-talk function operates in keying circuit of the M-5569 transmitter. Power supply is self-contained. This equipment will operate with any low level Hi-Z microphone and supply 100% modulation to the 65 watt input carrier. (con't)



**MODULATOR/AMPLIFIER FOR 65 WATT TRANSMITTER**

**SPECIFICATIONS**

**APPLICATION:** Designed for high level modulating the M-5569 transmitter on preceding page. May be used with any similar powered transmitter, however.

**AUDIO INPUT:** Hi-Z for use with M-4576 microphone listed herein with push-to-talk desk stand. Any similar microphone of dynamic or crystal type may be used.

**LIMITER:** Fast acting with limiter action indicated on meter.

**LOW-PASS FILTER:** Cuts off audio response at 5000 cycles 40 db or better.

**RESPONSE:** ±3 db, 300 to 2500 cycles. Down 20 db at 50 cycles and 40 db at 5000 cycles.

**DISTORTION:** 8% or less, 300 to 2500 cycles.

**NOISE:** 40 db or better below the equivalent to 100% modulation of a 65 watt (input) transmitter.

**TUBES:** Two each 12AT7, 6146, 5R4GY, VR-105. One each 5879, 6AK6.

**SIZE:** Rack mounted — 19" wide, 10½" high, 14½" deep.  
In cabinet as illustrated — 20½" wide, 12" high, 15" deep.

**POWER:** 115 volts, 50/60 cycles at 240 watts (100% modulation).

**WEIGHT:** 90 lbs. packed. Cubage 4.

**ORDERING INFORMATION**

**Modulator complete with tubes, less microphone** ..... M-5570  
**100% spare tube kit for above** ..... TK-292  
**Microphone with push-to-talk stand, cord and plug** ..... M-4576

NOTE: Microphones listed next page.

**COMPLETE 65 WATT TELEPHONE,  
85 WATT CW TRANSMITTER**



Consists of the M-5569 transmitter and M-5570 modulator/amplifier, fully described on the preceding pages. When used with the M-4576 push-to-talk microphone unit, illustrated at the bottom of the page, a complete telephone and telegraph transmitter that will meet all current regulations, tune continuously from 2 to 32 megacycles, is ready to attach to a wide variety of antennas from 30 to 300 ohms.

Either horizontal or vertical mounting of the transmitter and amplifier cabinets is practical. The two cabinets connect together with one cable having heavy plugs on each end. Rack mounting along with other equipment is another excellent method of installation and this equipment is offered in that manner also.

Here is a commercial AM high frequency transmitter that will handle 24-hour day schedules with complete reliability. Tuning all frequencies between 2 and 32 Mc from the front panel, having ten crystal positions, a sharp, easy to ready voice quality and fast action peak limiting for full modulation without over-modulation, those requiring the very finest will appreciate this new Gates transmitter. Separate power supplies in the transmitter and modulator units make them independent of each other and assure all the benefits of dual power supplies for RF and modulator. For specifications, please refer to the preceding page on the M-5569 and M-5570 equipments.

**ORDERING INFORMATION**

**Complete transmitter with tubes but less microphone and crystals** .....CM-65  
**Complete transmitter, same as above but less cabinets, for rack mounting** .....CR-65  
**Push-to-talk microphone unit complete** .....M-4576  
**Crystal and holder for 0.02% accuracy** .....H-17  
**Temperature controlled oven to hold two Type H-17 crystals for .003% accuracy** .....JKO2

M-4576 dynamic microphone with push-to-talk desk stand, 7' cable and plug. Grip handle and transmitter turns on, release and it turns off. Output, —55 db. Hi-Z type.



# SSB-100 SINGLE SIDEBAND TRANSMITTER RECEIVER

Model SSB-100



The SSB-100 single sideband transmitter/receiver is a complete 100 watt SSB radio station primarily intended for point to point radio communication and including in the one cabinet both transmitter and receiver. With the use of SSB techniques, a performance equivalent to that provided by conventional amplitude modulated (AM) equipment of several times the power output may be obtained simply and at low cost. Other advantages resulting from SSB operation are much improved intelligibility during reception of signals subject to selective fading and reduction in interference from other transmissions due to a narrower and more sharply defined receiver passband.

The transmitter follows normal SSB design but has been simplified where feasible. Speech signals pass through the microphone amplifier to the 250 Kc/s balanced modulator. The upper sideband product is selected by a mechanical filter and then shifted to an IF frequency of 1650 Kc/s in the second modulator. After amplification at this frequency, the signal is shifted to the radiated frequency in

the third modulator. Two linear amplifiers follow and the output stage feeds the antenna via a Pi-L network.

The receiver employs 3 successive frequency translations using the same IF frequencies as the transmitter. A tuned RF stage is included and a mechanical filter identical with the transmitter filter is used to select the wanted sideband. The audio output amplifier drives a loudspeaker mounted within the unit.

Audio squelch circuitry is provided to remove annoying noise when no signal is being received.

All local oscillators are crystal controlled with the crystals mounted in thermostatically controlled ovens in order to achieve the required frequency stability.

The power supply circuits are conventional and provide high voltage, low voltage and bias supplies for the equipment.

**SSB-100 SINGLE SIDEBAND TRANSMITTER/RECEIVER**



**FEATURES**

**POWER ADVANTAGE** — The radiated energy in SSB operation is concentrated in one sideband only. This results in a 4 to 1 power advantage over conventional AM operation for a given output rating when used with a SSB receiver.

**SPECTRUM ECONOMY** — The use of half the spectrum space necessary for AM permits closer spacing of HF SSB channel assignments.

**REDUCED INTERFERENCE** — The narrower bandwidth requirements result in reduced interference with other services.

**TUNE-UP PROCEDURE** — A self-contained audio oscillator facilitates tune-up procedure.

**COMPATIBILITY** — Compatibility in communicating with AM equipment is possible through re-inserting the carrier on transmission, and using on reception, the separate true envelope detection system which is incorporated in the SSB 100.

**RECTIFIERS** — Silicon rectifiers only are used in the power supply for increased reliability.

**GREATER INTELLIGIBILITY** — The reduction of frequency selective fading in a SSB system, results in decreased distortion and greater intelligibility especially under marginal signal conditions.

**DUPLEX FREQUENCY OPERATION** — The option of operating with different transmit and receive frequencies in each channel is an important advantage not available on most competitive equipment.

**SPEECH CLIPPER** — The clipper increases the average transmitted speech power using simple and reliable circuitry.

**TECHNICAL SPECIFICATIONS**

**GENERAL**

- Frequency Range: 2-15.0 Mc/s.
- Channels: 4 crystal controlled channels using the same frequency for transmit and receive  
or  
2 crystal controlled channels using different frequencies for transmit and receive
- Service: Single sideband with suppressed carrier (A3a)  
Single sideband with transmitter carrier CW telegraphy (A1)  
Keyed tone telegraphy (A2)  
Either upper or lower sideband may be selected  
Double sideband AM telephony (A3) can also be received
- Power Source: 117/230 volts, 50/60 cps, single phase Silicon rectifier.  
Approx. 175 volt amperes required for receive and 300 volt amperes required for transmit
- Size: Cabinet for desk mounting - Width 19", depth 18½", height 12"
- Weight: 61 lbs.
- Environment: Temperature range 0° - 50°C  
Humidity range 0% - 90%
- Antenna: Resistance 5 to 50 ohms. Reactance - 500 to 0 ohms

**RECEIVER**

- Signal/Noise Ratio: 12 db min for 1 $\mu$ V input
- Selectivity: (a) SSB BW. 6 db 3.2 Kc  
                    BW. 60 db 5.4 Kc  
                    (b) DSB BW. 6 db 7.5 Kc  
                    BW. 60 db 70 Kc
- Spurious Rejection: -70 db including images and sub-carrier responses
- Audio Response: Within 3 db from 350-3000 c/s
- Audio Output: 1.5 W maximum. More than 50 m W output with 1 $\mu$  V input.

**TRANSMITTER**

- Power Output: 100 watts PEP
- Carrier, 36 db
- Spurious Suppression: Unwanted sideband, 50 db
- Second harmonic, 50 db into a 52 ohm load
- Spurious radiation, 50 db
- Intermodulation- At least 30 db below either of two equal tones resulting in PEP of 100 Watts
- Frequency Tolerance:  $\pm$  0.0005%
- Audio Response: Within 3 db from 350-3000 c/s

**ORDERING INFORMATION**

- SSB-100 Transmitter/receiver with tubes, less crystals ..... M-5805
- Crystal for any frequency (specify when ordering) each ..... M-5882
- Microphone with push to talk desk stand ..... M-5883
- Spare 100% tube complement ..... TK-353

# RADIO FREQUENCY REFERENCE SYSTEM

Model M-5687

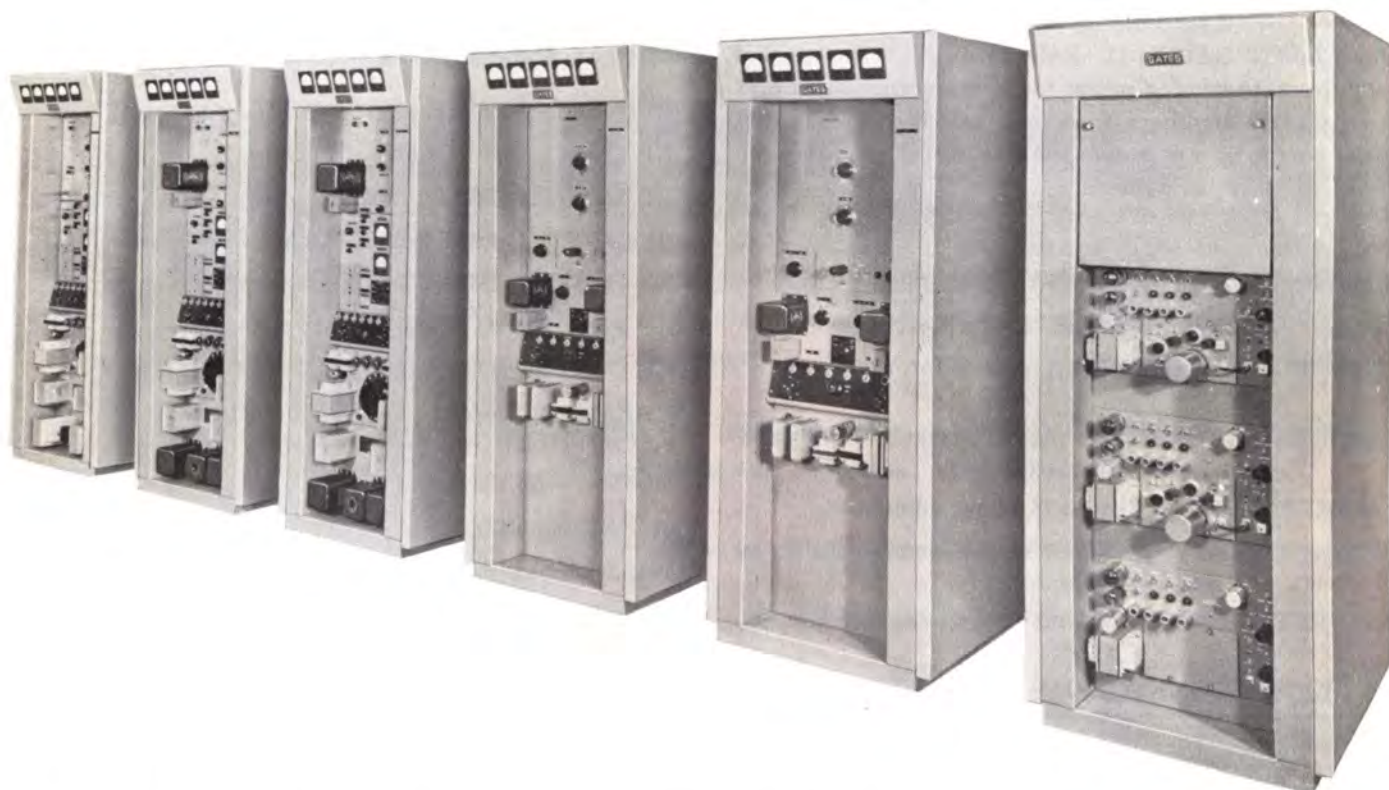

The Gates M-5687 radio frequency reference system consists of five individual power amplifiers, along with a sixth cabinet, which contains three frequency control units, each with its own buffer amplifier. The first of the power amplifiers is a 1000 watt, 46-54 MC amplifier. It requires a driving power of 1 watt at the desired output frequency. The second unit is a 1000 watt 430-480 MC amplifier which requires a driving power of 1 watt at one-ninth of the desired output frequency. The third amplifier provides 100 watts output power in the range of 860-960 MC with an input power of 1 watt at one-eighteenth of the desired output frequency. In the complete system the 48 MC and 440 MC amplifiers are duplicated to provide for complete reliability.

The Gates M-5687 transmitting system is used normally in the UDOP system of measuring the velocity and posi-

tion of guided missiles to an accuracy which is unobtainable with any other system. The individual amplifiers, all of which are completely self-contained, can be provided for other applications.

In the system application, phase shift between amplifiers can be held to less than  $5^\circ$  during a fifteen minute operating period. Each of the oscillator-buffer amplifiers will provide a full 10 watts of driving power so that two or more of the individual amplifiers can be excited from one frequency source in the 46-54 MC range.

Built for trailer installation, all of the units in the system are ruggedized to allow this transportability. Your questions concerning individual application of the amplifiers will be welcomed. (con't)

## M-5687 RADIO FREQUENCY REFERENCE SYSTEM

### SPECIFICATIONS

*(Moving from right to left in the group photo)*

**OSCILLATOR-COAXIAL PATCH BAY:** The coaxial patch panel provides a means to drive any combination of three power amplifiers from any one buffer amplifier power source or any combination of buffer amplifier and power amplifier as desired.

#### **M-5708, M-5709 Oscillator Buffer Amplifier Unit**

**TUNING RANGE:** 46-54 MC crystal control.

**FREQUENCY STABILITY:** 1 x 10<sup>-7</sup> for 15 minutes.  
1 x 10<sup>-5</sup> for 8 hours.

**FREQUENCY CHANGE:** 1 part in 20,000 by front panel control.

**OUTPUT IMPEDANCE:** 50-75 ohms, adjustable.

**POWER OUTPUT:** Oscillator 10 milliwatts — Buffer 10 watts.

**A.C. POWER INPUT:** 105-125 Volts, single phase, 60 cycles.

**RF OUTPUT CONNECTION:** Type UG-291/U.

**SIZE:** 5½" x 8½" with rear cover projecting 2¾" at rear.

#### **M-5704, 1 KW CW AMPLIFIER**

**RF INPUT FREQUENCY RANGE:** 46-54 MC.

**RF INPUT IMPEDANCE:** 50 ohms.

**RF INPUT POWER:** 1 Watt.

**RF OUTPUT FREQUENCY RANGE:** 46 to 54 MC.

**RF OUTPUT IMPEDANCE:** 50 ohms.

**RF OUTPUT POWER:** 1000 watts.

**RF OUTPUT FITTINGS:** 1½" RETMA flange.

**HARMONICS, 2nd:** At least — 80 db.

**ALL OTHERS:** At least — 60 db.

**NOISE:** —60 db.

**MONITOR OUTPUT:** Minimum 10 MW into 50 ohms.

**PHASE STABILITY:** Less than 10° over 15 minute period, after 1 hour warm up.

**AC POWER INPUT:** 120/208 volt, 3 phase, 4 wire, 60 cycle.

Provision made to remote control unit over telephone pairs.

**SIZE:** 66 inches high x 25½" wide x 36" deep.

#### **M-5705, 1 KW CW AMPLIFIER**

**RF INPUT FREQUENCY RANGE:** 46-54 MC.

**RF INPUT IMPEDANCE:** 50 ohms.

**RF INPUT POWER:** 1 watt.

**RF OUTPUT FREQUENCY RANGE:** 430-480 MC.

**RF OUTPUT IMPEDANCE:** 50 ohms.

**RF POWER OUTPUT:** 1000 watts.

**RF OUTPUT FITTINGS:** 1½" RETMA flange.

**HARMONICS,—2nd:** —80 db or better.

**ALL OTHERS:** —60 db or better.

**NOISE:** —60 db.

**MONITOR OUTPUT:** 10 MW into 50 ohms.

**PHASE STABILITY:** Less than 10° over 15 minutes after 1 hour warm up.

**AC POWER INPUT:** 120/208 V, 3 phase, 4 wire, 60 cycles.

Provision is made to remote control over telephone pairs.

**SIZE:** 66" high x 25½" wide x 36" deep.

#### **M-5706, 100W CW AMPLIFIER**

**RF INPUT FREQUENCY RANGE:** 46-54 MC.

**RF INPUT IMPEDANCE:** 50 ohms.

**RF INPUT POWER:** 1 watt.

**RF OUTPUT FREQUENCY RANGE:** 860 to 960 MC.

**RF OUTPUT IMPEDANCE:** 50 ohms.

**RF POWER OUT:** 100 watts.

**RF OUTPUT FITTINGS:** 1½" RETMA flange.

**HARMONICS:** 60 db.

**NOISE:** 60 db.

**MONITOR OUT:** 10 MW into 50 ohms.

**SIZE:** 66 inches high x 25½" wide x 36" deep.

**WEIGHT:** 1200 lbs.

Provision made to remote control unit over telephone lines.

**AC POWER INPUT:** 120/208, 3 phase, 4 wire, 60 cycle. Provision for a continuous reduction of RF power out.

60 db below the nominal 100 watts out.

## 250/300 WATT SPECIAL PURPOSE VHF TRANSMITTER



This transmitter has been designed for special applications where highly stable equipment is mandatory such as in Guided Missile projects or any application where a better than the best commercial standard is required.

Second and higher order harmonics are attenuated 80 db or better by special attention to shielding and RF circuitry. Carrier noise is also maintained at 80 db or better below the carrier fundamental. This, in part, is accomplished by application of direct current to the filaments of the final power amplifier stage. — Carrier frequency can be maintained at one part in 10 million over a period of at least 15 minutes and 10 parts in one million over periods of 8 hours or longer.

Designed for continuous duty, the M-5077 transmitter is fully metered and fully protected with a generous relay and circuit breaker system.

Also available are the M-5551 Dovap transmitter with frequency range of 30 to 40 Mc, and the M-5552 50 watt transmitter. (Same basic design as the M-5077). Write for specific information on these models.

## 2 KW VHF PRECISION TRANSMITTER

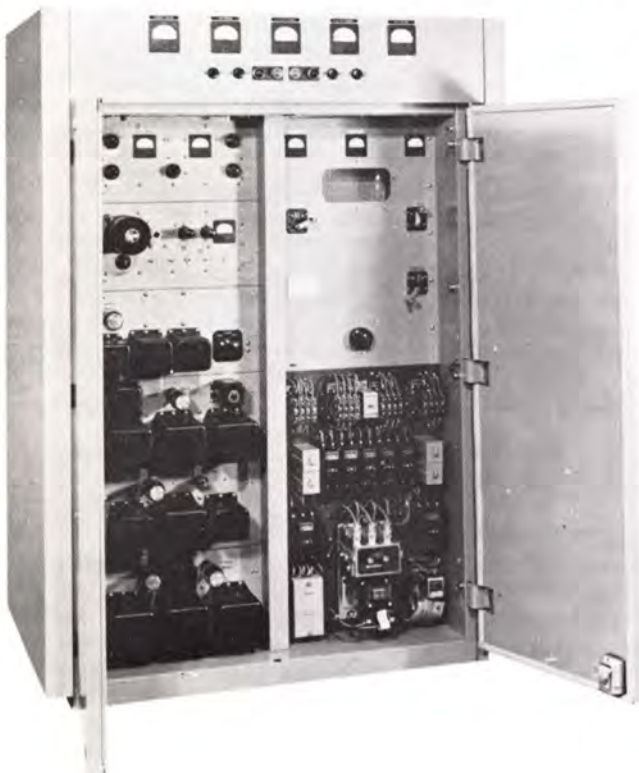

The Doppler technique used for velocity measurements in the testing of guided missiles and many similar applications requires a precision transmitter with the highest quality standards. The Gates M-5076 transmitter is designed for the 30-40 Mc band, produces a full 2KW output at continuous duty and has inbuilt features that meet exacting demands. Harmonic or spurious radiation, by use of shielding and choice of circuitry, at second and higher order harmonics is 80 db or better below fundamental carrier. Separate direct current filament supplies are provided for each of the 4-1000A power amplifier tubes, which along with the 3-phase plate supply assures carrier noise reduction of 80 db or better. Generous use of intermediate power supplies for exciter, driver, final PA screen and bias adds to both good regulation and reliability. A remote control unit as standard equipment, when operated on two standard telephone pairs, permits operation on as much as 10 miles of line. Transmitter may be turned on and off and keyed remotely. Carrier frequency may be held to one part in 10 million for 15-minute periods and 10 parts in one million for extended periods of 8 hours or longer. Write for specific information on this model.



# HOMING BEACON TRANSMITTER

Model MO-3975



Built to JAN specifications, 400 watts maximum power output with variable front panel power selector for lower powers to 25 watts. Includes associated antenna coupler, remote control station and automatic code keyer. Frequency range, 200-800 Kc.

The Gates MO-3975 low frequency homing beacon transmitter is designed for operation at any carrier power up to 400 watts. Carrier power is adjustable down to 25 watts by means of a tapped auto transformer controlled with a heavy tap switch on front of the transmitter. Pressurized forced air cooling is provided. High level modulation is employed, along with a complete audio system incorporating a peak limiter to prevent over-modulation, and a type 36 code keyer operating from a phase shift type audio oscillator at 1020 cycles.

General construction is to JAN specifications, in heavy steel frame to which each drawer section is secured by captive thumb screws. Design is heavy enough to stand Class B shock tests and operate in ambient temperatures between  $-54^{\circ}$  C. and  $+65^{\circ}$  C. — Automatic reset of the carrier provides 4 instantaneous recycling periods

before turn-off. Transmitter may be reset from the switch provided on the remote control unit.

Xenon gas type high voltage rectifier tubes are employed to permit operation in extremely low ambient temperatures. — RF output is 51.5 ohms unbalanced, which may feed into coupling unit of purchaser's design or the Gates MO-4116 tuning unit which is designed to couple into T type antenna 200' on the horizontal and vertical down lead heights from 15 to 50 feet.

The remote unit consists of complete speech amplifier along with transmitter off-on switch. Amplifier is provided with decibel meter, level control and dynamic microphone of 50 ohms impedance attached to push-to-talk desk stand. — Designed either for desk or rack mount. Size  $10\frac{1}{2}''$  x  $19''$  x  $12''$ .

## SPECIFICATIONS

- CARRIER POWER:** Maximum, 400 watts; minimum, 25 watts.  
**MODULATION:** Class AB 1 high level — voice, or code wheel keying at 1020 cycles.  
**KEYER:** Type 36 code keyer 8 RPM or equal to 4/6 RPM. Code wheel has 60 segments allowing for any three-letter identification with code signal. Segments are of stainless steel and adjustable with ordinary screw driver.  
**CARRIAGE RANGE:** 200 to 800 Kc.  
**FREQUENCY STABILITY:** 0.003%.  
**AUDIO RESPONSE:**  $\pm 2$  db 400-3000 cycles with sharp cut-off at 3000 cycles and gradual roll-off below 400 cycles for good voice quality.  
**NOISE:** 40 db below 100% modulation at 400 watts.  
**DISTORTION:** 6% or less 400-3000 cycles.  
**RF IMPEDANCE:** Transmitter, 51.5 ohms. When used with M-4116 coupler, to couple to T antenna 200' long and lead in to 50'.  
**AUDIO IMPEDANCE:** Transmitter, 600 ohms —10 db for 100% modulation at 400 watts output. Microphone input, 50 ohms.  
**CONTROL:** Local or remote by means of 3-wire cable or 600 ohm 2-wire simplex telephone line.  
**POWER CONSUMPTION:** 2200 watts at 115 volts, 60 cycles, single phase at full power output.  
**TUBES:** 5670 (2C51) crystal or VF oscillator; 6AC7 first IPA, 807 second IPA, 4-400A power amplifier, PP 4-250A modulators, PP 6SJ7 audio drivers, pair 4B32 xenon gas rectifiers, pair 5U4G low voltage rectifiers, 6X5GT bias rectifier and 6L6 clamp tube. — Remote unit, three 6SJ7 and one each 5U4G, VR105.  
**METERING:** Individual 3" meters provided for: power line voltage, elapsed time, second IPA plate, PA grid, PA plate, modulator plate and RF output. — Single multi-metering for crystal oscillator plate, first IPA plate and second IPA grid.  
**SIZE AND WEIGHT:** Transmitter 72" high, 26" wide and 30" deep, closed. Added 24" from front to back with drawers out. — Weight packed, 1400 lbs., 60 cu. ft. Antenna coupler and speech unit not included. Weight of remote unit, 80 lbs., 4 cu. ft. Weight of remote antenna coupler, 120 lbs., 8 cu. ft.

## ORDERING INFORMATION

- Transmitter complete with tubes and self-contained code keyer, less antenna coupler, remote control unit, and crystal** ..... M-3975  
**Antenna coupler complete** ..... M-4116  
**Remote control/audio amplifier, less microphone** ..... M-4033  
**Microphone and desk stand assembly** ..... M-4124  
**Crystal (state frequency)** ..... H17

# UHF COMMAND TRANSMITTER and CHECK-OUT GENERATOR



The Gates Model MPS-41 Command Transmitter and Model MPS-73 Checkout Generator are manufactured for operation on one fixed RF frequency in the range of 406-550 MC. Both are highly stable units designed for operation over a very wide range of ambient temperature and humidity. Both units provide up to 12 high-stability audio and supersonic tones for control functions. The tone generators are capable of extremely rapid keying with a minimum of keying transients.

The Command Transmitter consists of 2 lightweight, though ruggedly built, units of approximately relay rack dimensions, one of which is 4 1/2 feet tall and the other, the power supply, being 3 ft. in height. These units can be truck or trailer mounted for convenience and will withstand forces of 10 g's while in transit between operating locations.

The Checkout Generator is identical to the transmitter except for size and output power. It is intended for relay rack mounting and is pictured here in an open rack for detail. With its output continuously variable in the range of 5-100,000 microvolts, it is ideal for checking out a drone or missile control system prior to launching. It is, of course, used in close proximity for convenience.

Many variations of these units can be provided. For example, the transmitter can be provided in power outputs up to 1 KW. Tone oscillators can be provided with relay keying rather than electronic gating. On special order, multi-channel units can be provided for instantaneous frequency change.

## SPECIFICATIONS

### TRANSMITTER

FREQUENCY RANGE: 406-550 Mc.  
 FREQUENCY STABILITY: .0025%.  
 POWER OUTPUT: Transmitter — 150 Watts.  
                                 Generator — 5 to 100,000 microvolts.  
 HARMONIC & SPURIOUS EMISSION: 60 db below carrier level.  
 OUTPUT IMPEDANCE: 50 - 52 ohms.  
 FREQUENCY SWING: ±200 Kc Max.

### MODULATOR

Up to 12 modulating oscillators are provided in the frequency range of 7.5 to 40 KC (Exact frequencies as specified by customer.)  
 10 crystal controlled audio oscillators are normally provided along with 2 variable frequency oscillators.  
 AUDIO OUTPUT: Variable from ±20 to ±75 KC.  
 STABILITY: ±10 cycles.  
 DISTORTION: 3% or less.  
 MODULATING OSCILLATORY KEYING: Electronically gated.  
 GATING CHARACTERISTICS:  
     +15 VDC opens gate.  
     +4 VDC or less gate closes.  
     Gating current 300 ua or less  
 KEYING TRANSIENTS: Exceed steady state amplitude by not more than 30%.  
     Do not exceed 300 microseconds duration.  
 TONE SIGNAL STABILITY: Amplitude of single keying tone changes less than 5% when up to 4 additional tones are keyed.



## ORDERING INFORMATION

UHF Command  
 Transmitter ..... MPS-41  
 Checkout Generator ..... MPS-73

# VLF LINEAR AMPLIFIER

Another example of Gates engineering leadership is the wideband VLF 10 KW amplifier which is used in the "CONSOL" navigation system. The center operating frequency of this unit is 190 KC, however, its frequency range extends from 140-240 KC without any retuning. RF input power required is 50 milliwatts at the desired operating frequency to provide an output power of 10 KW or more.

Extremely high stability is provided in this amplifier to

the extent that the output signal is in phase with the input signal to a tolerance of ±2°. Provisions are made within the amplifier to provide for up to 30% tone modulation (A2 emission) and the unit is capable of blocked grid keying up to fifty words per minute.

This amplifier is built to perform under the extremely rigorous environmental requirements set forth by the Federal Aviation Agency in its Specifications FAA-R-777.

# 50 WATT VHF AM TRANSMITTER

Model M-5610

The Gates M-5610 Transmitter has been designed to provide a highly reliable, short range, VHF communications unit which is capable of continuous operation.

The transmitter is constructed in a waist-high rack cabinet, but can be provided for rack mounting in the regular manner if desired. The cabinet model size is 38" high, 24" wide and 23" deep. These transmitters may be installed one on top of the other if such mounting is more convenient for the customer.

This transmitter will provide a full 50 watts of amplitude modulated power output (approximately 90 watts input power) over the entire range of 90-150 MC. It is designed for crystal control operation on any one frequency within this range and if a frequency change becomes necessary in the field, it can be accomplished very readily.

High level plate modulation is used to provide maximum reliability and easiest possible servicing. The modulator provides its own separate power supply in order to maintain the low carrier shift so necessary in this service.

The modulator incorporates a fast acting limiting amplifier to maintain high modulation percentages. The audio input will accommodate either a crystal or high-impedance dynamic microphone. Push-to-talk operation can be used with any normal system and if desired Gates can provide a standard microphone with push-to-talk desk stand which has been designed to operate with this transmitter.

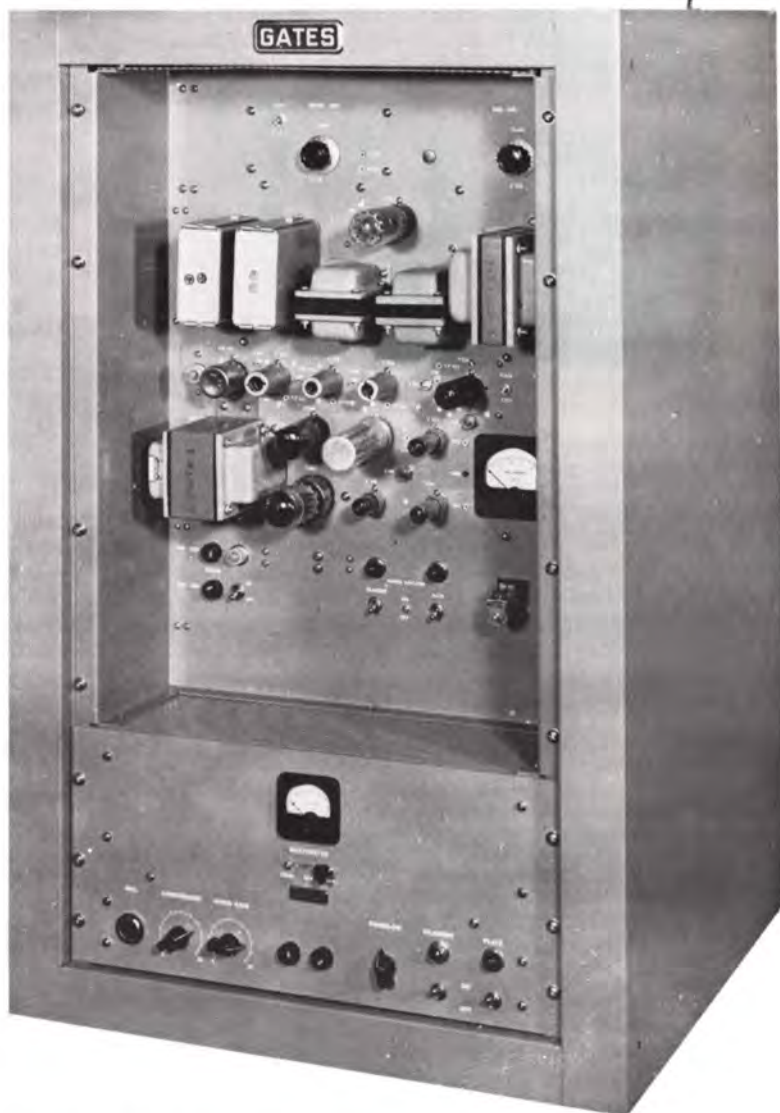

## SPECIFICATIONS

POWER OUTPUT: 50 Watts.  
 FREQUENCY RANGE: 90 to 150 MC.  
 RF OUTPUT IMPEDANCE: 50-75 ohms.  
 TYPE OSCILLATOR: Crystal Control — overtone type crystal.  
 FREQUENCY STABILITY: .005% standard — up to .0005% available.  
 AUDIO INPUT: Hi-Z for Crystal or Dynamic microphone.  
 FREQUENCY RESPONSE: ±3 db 300 to 2500 cycles.  
 Down 20 db at 50 cycles and 40 db at 5000 cycles.  
 AUDIO DISTORTION: 8% or less 300 to 2500 cycles.

NOISE: 40 db or better below 100% modulation.  
 HARMONIC RADIATION: 50 db or better below carrier.  
 POWER INPUT: 117 VAC, 60 cycles, 350 watts.  
 SIZE: 38" high, 24" wide, 23" deep. (Cabinet model)  
 WEIGHT: Approx. 200 lbs. packed for shipment.  
 CUBAGE: 17 cubic feet.  
 TUBE COMPLEMENT:

1 - 5894	1 - 6AU6
1 - 6360	1 - OB2
3 - 6AK6	2 - 6550
3 - 12AT7	1 - 5879
1 - GZ34/5AR4	2 - OC3
1 - 6080	3 - 5R4 GY

# TOTALIZING RECORDER



Gates MO-3815 Totalizer is a precision unit used to record the time a signal is at or above a pre-selected value. It is widely used for measuring the field intensity of high frequency signals in propagation tests. It is designed for extreme accuracy and stability over long periods of time.

Used with a high quality receiver and fed off the rectified output. The input voltage range of the Totalizer is 0 to -10 volts DC. Any of the ten channels may be set to any voltage within this range. The sensitivity of the Totalizer is guaranteed to be within .05 volts DC input, however average readings are from .002 to .005 volts. This sensitivity is the difference in the voltage required to energize the channel and to de-energize it. Thus, a channel may be set up to energize with nine volts input and will de-energize when the signal drops to 8.998 volts. The isolation between any or all of the ten channels is great enough to permit setting them up in an increasing sequence of .05 volts apart, yet no interaction of channels will occur.

Each channel, when energized, starts a synchronous one

RPM motor that drives a Veeder-Root counter. The counter reads in tenths of minutes and will total up to 9,999.9 minutes. A front panel reset wheel allows resetting from any reading to zero with one revolution of the wheel. The control unit and the counter unit are separate.

## SPECIFICATIONS

**CONSTRUCTION:** Totalizer recorder: 14"x19" cast aluminum panel and shelf with drop down front door for component servicing. Finish, gray. Counter panel: 5 1/4" x 19". Finish gray.

**TUBES:** Eleven 6SL7, ten 6SJ7, one each 6Y6G, 6SN7GT, OD3.

**RELAYS:** Hermetically sealed.

**POWER:** 115 volts, 60 cycles, approximately 200 watts.

**EQUIPMENT SUPPLIED:** Totalizing recorder amplifier, totalizing counter panel, 10' interconnecting cable, 100% set tubes.

The M-3815 Totalizer is also available less the counter panel where other indicating devices are preferred to that of the direct reading counter.

## ORDERING INFORMATION

- Totalizer complete with counter panel and tubes (as illustrated) ..... **M-3815**
- Totalizer unit with tubes but less counter panel **M-5507**
- 100% spare tube kit ..... **TK-230**

# BFR-50C FM RELAY TRANSMITTER



Designed for 50 watt FM service and available at any frequency between 40 and 220 Mc and for any frequency swing. Models below 80 Mc have maximum swing of ±40 Kc or less, as desired. Above 80 Mc may be ±75 Kc or less, as desired. General specifications of this model are found on Pages 56 and 57 (Model BF-E-50B). This model differs as outlined above and has (1) 5894 tube, (1) 6AQ5 tube, and (1) 5R4GYA tube added.

Multiplex is also available as an optional accessory in single or dual sub-channels. In relay service this offers many possibilities such as a talking channel or second program channel.

Where the full, wide frequency response is not desired, the BFR-50C transmitter may be used with the communications "Limiter/Filter Amplifier" listed on Page 229.

## ORDERING INFORMATION

- 50 watt relay transmitter for 40-220 Mc operation, with tubes, crystal and oven\* ..... **BFR-50C**
- Spare 100% tube kit for above ..... **TK-310**
- Single multiplex sub-channel ..... **M-5633A**
- Dual multiplex sub-channel ..... **M-5633**

\*State carrier frequency and frequency swing desired, when ordering.

# COMMUNICATIONS — LIMITER/FILTER AMPLIFIER



Designed to provide microphone and line input to any communications transmitter. Embodies both limiting amplifier and high frequency cut-off filter to meet present FCC specifications. Ideal for use with new transmitters or existing communications transmitters in modernizing them to meet current FCC requirements by reducing high frequency response above 3000 cycles, and providing a fast acting limiting amplifier to prevent over-modulation of the transmitter.

Provides input circuits for either a high impedance microphone or 600 ohm line — switchable from front panel. Gain controls are provided for adjusting level of: (a) input line, (b) master gain and microphone level, and (c) input level to transmitter. A 3" meter is provided to indicate compression point.

Available in two types. M-5263 has a maximum output of +18 dbm at 600 ohms. M-5263A has a maximum output of 75 volts RMS for push-pull 100,000 ohm grids. Both models have self-contained power supply.

### SPECIFICATIONS

INPUT IMPEDANCES: Mic. Hi-Z. Line 600 ohms.  
 OUTPUT IMPEDANCES: M-5263, 600 ohms. M-5263A, 100,000 ohms.

**GAIN:** M-5263, from line to output 56 db, from mic to output 86 db +3 db.

M-5263A, line to output 42.5 db, mic to output 72 db +3 db.

**COMPRESSION:** (Min. threshold) mic -63 db +3 db. Line -33 db +3 db.

**NOISE:** 45 db or better below +18 dbm output.

Measured with input of -55 dbm and 5 db compression.

**DISTORTION:** At compression levels up to +20 db does not exceed 5%.

At compression levels up to 30 db does not exceed 10%.

**FREQUENCY RESPONSE:** With high frequency filter insert at all times, essentially flat 200-2500 cycles. Down 10 db at 100 and 3300 cycles. Down 20 db at 60 and 4000 cycles. Down 30 db at 35 and 4000 cycles. Down 40 db at 20 and 4800 cycles.

**POWER:** 115 volts, 50/60 cycles, approximately 40 watts.  
**TUBES:** One each, 6X4, 6AK6, 5879, OA2; two each 12AT7.

### ORDERING INFORMATION

Communications Amplifier, less tubes .....	<b>M-5263</b>
Communications Amplifier, less tubes .....	<b>M-5263A</b>
100% tube kit .....	<b>TK-235</b>

# SELECTIVE (HETERODYNE FILTER) AMPLIFIER



Basic principle is that of a selective audio filter, usually attached ahead of the audio system in the receiver or where attached to the 600 ohm output, a fixed pad should be inserted to provide input level. An additional amplifier is required in the latter case to provide loudspeaker level. Interference tone rejection coverage between 20-20,000 cycles is by means of a calibrated switch plus coarse and fine adjustments. Audio level control, pilot light, fuse and starting switch complete the front panel facilities.

### SPECIFICATIONS

**INPUT IMPEDANCE:** 600 ohms.  
**INPUT LEVEL:** Approximately 0 VU.  
**FREQUENCY RESPONSE:** +1 db 20-20,000 cycles.  
**DISTORTION:** 1 1/2% or less 20-20,000 cycles at +18 dbm.  
**NOISE:** 70 db or better below +18 dbm.  
**REJECTION:** 40 db up at 220 cycles and 50 db up at 220-20,000 cycles.  
**TUBES:** Four 6SN7, three 6SJ7, one each OC3, OD3 and 5Y3GT.  
**SIZE:** 19" wide, 5 1/4" high, 16 1/2" deep.  
**POWER:** 115 volts, 50/60 cycles at approximately 60 watts.  
**SHIPPING WEIGHT:** 35 lbs.

### ORDERING INFORMATION

Selective Amplifier with tubes .....	<b>M-3922</b>
Spare 100% tube complement .....	<b>M-4138</b>
Where customer requirements exceed 25 units, write for special quantity prices.	

Where receiving high frequency signals, the heterodyning of closely associated incoming signals, or two receivers beating at an audio rate, causes receiving difficulties which can often be either greatly improved or completely corrected by the use of the M3922 selective amplifier.

Where the interference tone remains constant, the elimination of any single audio frequency between 20-20,000 cycles is possible. If several interference tones are present, selective amplifiers may be placed in series and each undesirable tone reduced or eliminated so that readability of the received signal is greatly improved.

**REMOTE CONTROL SYSTEM**  
(for Communications)



A complete remote control system with microphone for operating a communications transmitter and receiver over 20 miles or less on a single telephone line. Features are:

1. Turns line power to transmitter, on and off.
2. Keys transmitter (puts transmitter on and off the air).
3. Selects one of 3 channels or one of 3 transmitters.
4. Amplifies and reproduces audio from receiver (over same pair of wires).
5. Adjusts squelch on receiver.
6. Provides intercom to transmitter location.
7. Includes "press to talk" dynamic microphone.
8. Automatic gain amplifier (limiter).
9. Large 4 1/2" meter reads audio level.
10. 300-3000 cycle response for communications.
11. 5" speaker self-contained.
12. Provision for foot key.

EQUIPMENT FURNISHED INCLUDES: (a) dynamic microphone with press to talk desk stand, (b) remote control unit as illustrated, and (3) switching line amplifier on rack mount 3 1/2" x 19" panel.

All equipment is self-contained except the switching line amplifier which requires 6.3 volts at 0.3A at 200/300 volts DC at 15 MA of external power. — This remote control system has unusual versatility and will adapt to nearly all needs. In some instances of multi-channel and power switching, added relays easily procurable from standard sources, might be required.

SPECIFICATIONS: For 115 volts, 50/60 cycles. Output level adjustable to +14 dbm. Size: 15" long, 9" high and 10 1/4" deep. Noise, 46 db below 0 level. Squelch, 0 to -20 volts to remote receiver. Tubes: 12AU7, 12AX7, 6AQ5, 6J8 and 5Y3GT.

Remote Control System, includes microphone .. 117C903

**CITIZENS BAND TRANS-CEIVER**



Here is a brand new transmitter and receiver for the 450-470 Mc citizens band. The first modestly priced unit that may be easily licensed to "service" and "industrial" organizations. Operates either on 12 volt car battery or 115 volts AC. Field and base station are identical for complete compatibility and interchangeability.

One cabinet 13" wide, 14 1/2" long and 5 3/4" high contains the complete transmitter-receiver package which includes self-contained loudspeaker and press to talk microphone. When combined with the Model 4002 whip antenna for mobile or permanent installation, nothing else is required.

Mileage range of this equipment cannot be definitely stated as location has varying effect. The TR500 citizens unit has 10 watts input or 40 to 50 watts output which is in excess of normal citizens band equipment. Under normal conditions, coverage or several miles can be expected.

SPECIFICATIONS: 100 db down selectivity at ±50 Kc. Band pass, 6 db down at ±20 Kc. Sensitivity, better than 20 db quieting for 1.0 UV input. Squelch range, 0-1 UV. Stability, ±.0025%. Duty cycle 20% or 1 minute transmit to 4 minute receive. Response, 300-3000 cycles. Spurious emission, 60 db below fundamental or better. — Made by Kaar.

Citizens band unit complete\* ..... TR-500  
Whip antenna ..... A-4002

\*State frequency when ordering.

**VFO-CRYSTAL  
OSCILLATOR-AMPLIFIER**



A specially designed unit for 540-1600 Kc operation providing the stability of crystal control on the operating frequency or switch to VFO for change to any broadcast frequency. Has calibrated dial in 10 Kc steps with 1-1500 dial and 200 cycles/div. straight line. Stability, crystal ±10 cycles. VFO ±200 cycles under normal operating conditions. Output, 2 watts at 70 ohms. — Size: 19" wide, 10 1/2" high and 6 1/2" deep. Further detail on this precision instrument will be supplied on request.

VFO/Crystal Oscillator-Amplifier ..... M-4230  
Crystal and oven (state frequency) ..... JK-57

# ACCESSORY EQUIPMENT

## 5" OSCILLOSCOPE



This large Hickok commercial scope is one of the industry's most popular. Frequency response wide band DC to 5 Mc and narrow band to 2.5 Mc within 3 db. Uses 5ADP1 flat faced cathode ray tube. Complete in every detail including illuminated calibrated green screen and filter. Size: 14" x 12" x 18" deep. For 115 volts, 50/60 cycles.

5" Oscilloscope ..... 770

## PORTABLE 5" OSCILLOSCOPE

This technician's model portable scope in the popular price class will fill all practical needs in AM radio and industrial testing. Response DC to 750 Kc within 3 db. Illuminated calibrated screen with green filter. Uses 5UP1 cathode ray tube with sharp trace detail. Size: 15" high, 10" wide, 16" deep. For 115 volts, 50/400 cycles.



Portable Oscilloscope ..... 685



## PORTABLE TUBE TESTER

Accommodates over 95% of all tubes in use today including new 11-pin socket and many foreign tubes. Along with standard requirements of a good tester, this model reads: grid current (gas) test, filament continuity test, constant indication of line voltage and Hickok famous roll chart for speedy data on tube to be checked. 17" wide, 11 1/4" long, 7 1/2" deep.

Portable tube tester ..... 6000

## INDUSTRIAL TUBE TESTER



A rugged industrial tester to serve almost every conceivable need. Tube leakage reads directly on meter scale, provision for measuring plate milliamperes and heater current. Outstanding feature is separate rectified DC voltage applied to each tube element in dual tubes permitting accurate balancing of such tubes as the 6SN7. Also tests selenium rectifiers and germanium cycles.

Industrial tube tester ..... 539B

## BLANK RACK PANELS

Made of 3/16" half hard flat aluminum stock 19" wide, punched standard relay rack mountings and finished in medium gloss gray. These are not the skimpy 1/8" blank panels but standard commercial thickness, available all widths from 3 1/2" to 19 1/4" in 1 3/4" multiples.

Blank panels, per 1 3/4" multiples ..... BL-1

## VOLT-OHM-METER



This Simpson model is the broadcaster's right hand. Over 1/4 million in use. Reads DC and AC voltage to 5000V, volume level in db to +50 db, resistance to 20 megs, and DC milliamperes to 500 and amperes to 10. With test leads.

Volt-Ohm-Meter ..... 260

## DESK RACK CABINET



Styled and finished in gray to match all Gates equipment as well as standard industry requirements. Holds 10 1/2" x 19" rack panel space with 1 1/4" inside depth clearance. Hinged lid and well louvered for ventilation. Size: 20 1/4" wide, 11 1/4" high, 15" deep.

Desk rack cabinet ..... M-5644

## CANNON XLR CONNECTORS



Popular small size Cannon connector used universally in radio and TV.

Symbol	Description	Cat. No.
G	Single, 3 prong, female, wall plate	XLR3-B5-2G
H	Cable plug, 3 prong, male	XLR3-12
I	Cable receptacle, female, 3 prong	XLR3-11
J	Chassis receptacle, female, 3 prong	XLR3-13
K	Chassis receptacle, male, 3 prong	XLR3-14

## CANNON P CONNECTORS

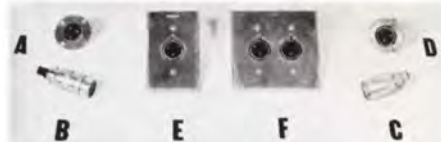

Long a popular, heavy duty connector in radio and TV. Approximately 1 1/8" in diameter.

Symbol	Description	Cat. No.
A	Receptacle for chassis mounting, male, 3 prong	P3-14
B	Cable receptacle, female, 3 prong	P3-GG-115
C	Cable plug, male, 3 prong	P3-GG-125
D	Receptacle for chassis mounting, female, 3 prong	P3-13
E	Wall plate with 3 prong female receptacle	P3-35
F	Wall mounting with two 3 prong female receptacles	P3-35-2G

## INDUSTRIAL MOBILE PHONE



A portable transmitter-receiver for industrial use such as talking from a fork lift to office, one fork lift to another or any mobile short range use up to one mile. Operates from 6 or 12 volts DC or 117 volts AC. Supplied with microphone, crystals, power cable and antenna. Use FCC Form 400 for easily obtained license. Power of transmitter, 3 watts. Accepted by FCC under Parts 9, 10, 11 and 16. State crystal frequency when ordering.

Industrial mobile phone for 30-50 Mc. TR-325  
Industrial mobile phone for 152-174 Mc. TR-426  
Industrial mobile phone for 108-152 Mc. TR-426A

## VACUUM TUBE VOLT-OHM-METER



A Simpson product indispensable in maintenance. Has 22 megohm input impedance, twice as high as any instrument in its class. Single DC/AC/ohms probe. Handles RF voltages to 150V RMS. Seven DC ranges to 1500V, seven AC ranges to 1500V. Peak to peak to 4000V. AF voltages (30-100 Kc ±5%) to 1500V ohms to 1 meg. in 7 ranges.

Volt-Ohm-Meter ..... 311  
RF probe for above ..... 0073

# ACCESSORY EQUIPMENT

## 100-RECORD AUDITORIUM SYSTEM



For the college student union, high school recreation room, restaurant and many applications where hours of automatic music from 45 RPM records can provide dance, concert, symphony or mood music.

Consists of special design record changer playing 100, 45 RPM discs on both sides or approximately 9 hours of music without attention. Changer is constructed in steel cabinet. Records may be set up in sequence of combinations desired and any record may be instantly rejected. Has dual diamond styli good for average 10,000 plays before replacement.

Standard equipment includes a Stromberg-Carlson 30-watt amplifier which may be mounted near or distant from the automatic record player. Amplifier will accommodate two microphones along with the changer and is capable of handling as many as 12 loudspeakers.

It is emphasized that this system is professional in every way and not to be confused with home record changers. This system may be as hi-fidelity in scope as the purchaser desires in the selection of loudspeakers as both the automatic record system and amplifier are Hi-Fi in design.

### SPECIFICATIONS

**SIZE:** (automatic changer in steel cabinet) 38 1/2" wide, 17 1/2" deep, 16 1/4" high. (amplifier) — separate unit shelf or desk mount.

**RATING:** From small rooms to auditoriums of 4000 seating capacity with proper speaker system.

**CUSTOM REQUIREMENTS:** Gates will gladly recommend proper speaker system by providing simple sketch of room or auditorium showing dimensions.

Auditorium system including 100-record changer in steel cabinet, 30-watt amplifier and instructions ..... **M-5666**

## TUBELESS MODULATION MONITOR



For reading modulation percentage in communications AM operated transmitters. Uses germanium rectifiers in place of tubes. Carrier level and modulation percentage meters are 3" square case.

### SPECIFICATIONS

**MODULATION INDICATION:** Reads 0-110% modulation and in decibels.  
**ACCURACY:** 2% at 100% modulation and 5% mid-scale.  
**FREQUENCY RESPONSE:** Within 2 db 50-10,000 cycles.  
**INPUT:** Requires about 1/4 watt. Input voltage 20V at 1000 kc or less. Input capacity 15 mmfd.  
**RF RANGE:** 2 to 30 mc.  
**Modulation monitor complete** ..... **Cat. M-3737**

## TRANSISTORIZED LOUDHAILER



The newest thing in electronic megaphones of tremendous power for commercial, industrial and sports. No tubes, yet supplies 3 watts with a small battery pack that will last approximately six months. Speak into one end and a loud clear voice covering easily 400 yards comes out the other. Size: 15 1/2" long, 10 1/2" bell. Weight 5 lbs. FCDA listed item P-2.

Loudhailer ..... **5907**  
 Battery kit ..... **GR-120**

## BLOWER



Delivers 270 CFM at 1.4" static pressure up blast. Squirrel cage, 1/4 HP motor, 115/230 volts, 50/60 cycles. Supplies ample air to cool two 3X2500 tubes when operating at the slower speed of 50 cycles. 17" high, 11 1/4" wide and 13" deep. Boot size: 3" x 10 3/4".

Blower .... **A-30687-1**

## 50 KW TUBE SOCKET

Designed for use with 5891, 50 KW tube as used in Gates BC-50C transmitter. Heavy ceramic insulation and chrome plated top ring.



Tube Socket ..... **B-40216**



## 3X2500 TUBE SOCKET

Ceramic insulated with aluminum base. Top section has fingers to grip plate ring on either 3X2500A3 or 3X2500F3 tube.

Tube Socket ..... **M3934**

## INVERTERS



For converting battery current to 110 volts AC in operating tape recorders, remote amplifiers, etc., from car battery.

For 6 volts DC to 110 volts AC at 80 watts ..... **6U-RSF**  
 Same as above but 150 watts ..... **6U-HSJ**  
 For 12 volts DC to 110 volts AC at 100 watts ..... **12U-RSF**  
 Same as above only 200 watts ..... **12U-HSJ**

## AUDIO TERMINAL BLOCK



Has 120 terminals in six rows. Molded one-piece phenolic black with base 3 1/2" x 6 1/8". Height 3 1/2". Terminals plated brass. Polished phenolic finish makes easy removal of solder splash.

Audio terminal block ..... **PT-106**

## HEAVY DUTY KEY



Large 1/4" coin silver contacts, chrome base. Navy type knob. Adjustable steel bearings and well designed spring give light keying touch. Finest hand key money can buy.

Telegraph key ..... **114-321**

## GATES TOUCH-UP PAINT

4 colors in 16 oz. aerosol containers. For any Gates equipment. Gives superior finish.

Light gray ..... **GF9**  
 Medium gray ..... **GF8**  
 Slate gray ..... **GF2**  
 Black ..... **GF3**



# ACCESSORY EQUIPMENT

## SSB CRYSTAL CONTROL



Permits the use of 10 precisely adjustable crystal positions available from the front panel for stabilities in SSB, and point to point or net operations becomes simple and straightforward. Frequency range 540 Kc to 31 Mc in 6 bands. Sensitivity 1 microvolt or better. Fifteen tubes plus rectifier and regulator. Size: 19" x 10 1/2" x 14" deep. 115/230 volts, 50/60 cycles. Uses CR 18/U crystals.

Receiver complete ..... GPR-90RX

## SINGLE SIDEBAND ADAPTER

Will adapt to any receiver which will provide 0.3 volts (RMS) RF input at 455 Kc. Is a filter type slicer for accurate SSB tuning. The 455 Kc input is converted to low frequency with a mixer/oscillator for selection of either sideband. Has electrical band spread for easy tuning of SSB. Output is at loudspeaker level. Size: 12" x 10" x 15" deep. For 115 volts, 50/60 cycles.



TMC SSN Adapter ..... GSB-1

## FM RELAY RECEIVER



Designed specifically for air pickup of FM broadcasting and retransmitting at full 30-15,000 cycle response at distortion of 1% or better 50-15,000 cycles. Bandwidth 150 Kc, 88-108 Mc, antenna 72 or 300 ohms, output 150/600 ohms. Crystal controlled oscillator for absolute negative drift. Sensitivity 2 Mv. for 20 db quieting or 10 Mv. for 40 db quieting. Has monitor speaker, signal strength meter and 12 tubes plus rectifier. Rack mount 8 3/4" x 19". Please state frequency when ordering.

Relay Receiver ..... CM-0

## CONELRAD RECEIVER



The New Conalert, 2 monitor Conelrad is specifically designed for Civil Defense and is FCDA approved Item 21. Required in all radio stations and very necessary in schools, hospitals, industries and those depending on Civil Defense. Continuously monitors all key radio stations to give warning for impending air attack. — Has 5 preset standard broadcast channels including 640 and 1240 Kc. Silent or audible monitoring, automatic visual and audible alarm, fail safe external alarm connection in case of receiver failure. Built in speaker. Seven tubes plus rectifier. Size (rack model): 19" x 8 3/4" x 9 3/4" deep. Cabinet model: 15" x 9" x 10 1/2" deep. For 115 volts, 50/60 cycles.

Conelrad Receiver, cabinet model ..... 117R905

Conelrad Receiver, rack model ..... 117R906

## TV REBROADCAST RECEIVER



High quality receiver used in rebroadcasting TV signals. 3 outputs, video, audio and sync. Sound and video channels are separate. Frequency control is excellent to point that drift on channel 13 is negligible.

### SPECIFICATIONS

VIDEO: Output 74 ohms at 1.5 volts peak to peak and response to 4 Mc.

AUDIO: Output +18 dbm, 600/150 ohms, 30-15,000 cycles. Distortion, 1% or less.

SYNC: Output 75 ohms at 4 volts peak to peak.

OTHER: RF input 75 ohms. Power, 115 volts, 60 cycles. Size: 19" x 13 3/4" x 8 3/4" deep.

TV Receiver ..... TR-1

## INDEX

ITEM	PAGE	ITEM	PAGE
Accessory Cabinet for Transmitters .....	87	Carritape (Cartridge Tape Unit) .....	144
Air-Dielectric Coaxial Cable .....	106	Ceiling Baffles, Loudspeaker .....	180
AM Transmitters .....	6 thru 43	Center Post Insulator .....	105
Amplifier, Cueing .....	161	Chair, Control Room .....	181
Amplifier, Equalizing Pre .....	139	Chokes, Tower .....	84
Amplifier, Limiting .....	154	Clocks, Studio .....	179
Amplifier, Monitoring .....	162	Coaxial Cable .....	106
Amplifier, Pre .....	171	Coils, Isolation .....	84
Amplifier, Program .....	171	Communications Receivers .....	188
Amplifier, Recording .....	180	Conelrad .....	41
Amplifier, RF Linear .....	226	Conelrad Receiver .....	188
Amplifier, Selective .....	228	Console, Sound Effects .....	129
Amplifier, 3-stage Pre .....	139, 170	Consoles, Speech Input .....	110 thru 128
Amplifier, Tubeless Tube .....	169	Console, Transmitter Control .....	94
Antenna Couplers .....	83	Control Room Chair .....	181
Antenna Diode Units for Remote Control .....	99	Couplers, Antenna .....	83
Antennas, Dummy .....	100	Cueing Amplifiers .....	161
Antennas for TV and FM .....	82	Cue, Sta-Level Patch Panel Cabinet .....	139
Antennas, Rhombic .....	107		
Arms, Pickup .....	138	Dage Television Cameras .....	71, 78
Audio Consoles .....	110 thru 128	Dage EPS-21 Television System .....	72
Audio Oscillator .....	176	Dage ETS-1 Television System .....	75
Audio Terminal Block .....	231	Dage Twin Generator .....	78
Auditorium Sound System (100 Record) .....	231	Dehydrators for Coaxial Cable .....	106
Automatic Program Level Amplifier (Sta-Level) .....	156	Desks for Speech Input Consoles .....	112, 116, 120
Automatic Programming Equipment .....	149 thru 153	Dial, Counter Type .....	103
Automote Automatic Remote Amplifier .....	168	Directional Phasors .....	85
Auto-Station Automatic Programming Equipment .....	153	Disc Cabinets .....	181
Auto-Trans Automatic Transcription Equipment .....	149	Disc Recorder, Presto .....	180
Average Level Amplifier (Level Devil) .....	158	Distortion Meter .....	176
		Dualux Speech Input Console .....	110
Baffles, Ceiling .....	180	Dummy Antennas .....	100
Baffles, Wall .....	180	Dynamote 4-Channel Remote Amplifier .....	163
Base Assemblies .....	171		
Biamote, 2-Channel Remote Amplifier .....	165	Equalized Preamplifiers .....	139
Blank Panels .....	230	Equalizers, Line .....	174
Blowers .....	231	Equalizers, Sound Effects .....	174
Boards, Control .....	110 thru 128	Equalizers, Transcription Turntable .....	138
Bowls, Feed-Thru .....	105	Eraser, Tape .....	181
Broadcast Transmitters, AF, FM, TV .....	6 thru 70		
		Feed-Thru Bowls .....	105
Cabinet, Desk .....	230	Field Intensity Meter .....	93
Cabinet, Disc .....	181	Film Cabinets .....	181
Cabinet, Film .....	181	Film Projectors for Television .....	79
Cabinet, Loudspeaker .....	180	Filter Capacitors .....	104
Cabinet, Rack .....	175	Flashers .....	107
Cabinet, Record-Tape .....	179	FM Exciter .....	60
Cable, Camera .....	74	FM Relay Receiver .....	188
Cable, Microphone .....	181	FM Transmitters .....	44 thru 60
Cable, Studio .....	181	Frequency Monitor, AM .....	88
Camera Control .....	74, 77	Frequency Monitor Extension Unit .....	99
Cameras, TV Film .....	71	Frequency Monitor, FM .....	93
Camera, Portable .....	78	Frequency Monitor, TV .....	79
Cameras, TV Studio .....	71		
Capacitors, Filter .....	104	Gain and Measuring Set .....	176
Capacitors, Mica .....	104	Gatesway Speech Input Console .....	114
Cartridges, Pickup .....	138	Gauge, Stylus .....	181
Cartridges for Carritape Unit .....	148		

**I N D E X**

ITEM	PAGE	ITEM	PAGE
Generating Plants, AC .....	82	Oscillator, Audio .....	176
Generator, Synchronous .....	78	Oscilloscopes .....	230
Ground Rods .....	106	Packaged Radio Broadcasting Equipment .....	40
Ground Screen .....	106	Paint, Touch-Up .....	231
Ground Strap .....	106	Panel and Shelf Assemblies .....	171
Ground Wire .....	106	Panels, Blank .....	230
Headphones .....	179	Panels, Patch .....	173
Heads, Cutting .....	180	Panels, Patch Video .....	80
Heat Exchanger .....	100	Patch Cords .....	173
Heliac Coaxial Cable .....	106	Patch Panels .....	173
Horn Gaps .....	105	Patch Panels, Video .....	80
Horseshoe Desk, CB-4 .....	134	Phase Monitor .....	93
Horseshoe Desk and Turntable Combinations .....	135	Phase Sampling Loops .....	84
Keys, Telegraph .....	232	Phasors, Directional .....	85
Kliegl Lights .....	80	Photo-Cell Units .....	107
Lenses (a complete listing will be found in the price list accompanying this catalog)		Pickup Arms .....	138
Lenses for Selectroslide Slides .....	79	Pickup Cartridges, Reluctance .....	138
Level Devil Amplifier .....	158	Power Supply .....	172
Lighting Equipment for Television Studios .....	80	Preamplifiers .....	171
Lights, Kliegl .....	80	Preamplifiers, 3-stage .....	139, 170
Lights, Studio Warning .....	179	Program Amplifiers .....	162, 171
Lights, Tower .....	106	Projector Control, Model PC .....	74
Limiter/Filter Amplifier for Communications .....	228	Projector, Film .....	79
Limiting Amplifier .....	154	Projector, Slide .....	79
Line Equalizers .....	174	Proof of Performance Equipment .....	176
Loudhailer, Transistorized .....	232	Rack Cabinet, Desk Type .....	230
Loudspeaker Matching Transformer .....	180	Rack Cabinets .....	175
Loudspeakers .....	178	Radio Frequency Reference System (UDOP) .....	221
Master Preset Control Console .....	129	Rebroadcast Receiver, TV .....	232
Meter, Distortion .....	176	Receiver, Conelrad .....	232
Meter Extension Kits for Remote Control .....	99	Receiver, FM Relay .....	232
Mica Capacitors .....	104	Receiver, Single Sideband .....	232
Microphone Accessories .....	178	Receiver, Television Rebroadcast .....	232
Microphone Cable .....	181	Recorder, Cartriptape .....	144
Microphone Connectors, Cannon .....	230	Recorder Cutting Heads .....	180
Microphones .....	177	Recorder, Disc .....	180
Microphone Stands .....	178, 179	Recorder, Spot Tape .....	140
Mobile Phone, Transceiver .....	230	Recorders, Tape .....	182
Modulation Monitor, AM .....	90	Recording Amplifier .....	180
Modulation Monitor, Short Wave .....	92	Recording Stylus .....	180
Modulation Monitor, Tubeless .....	232	Recording Tape .....	188
Monitor, FM .....	93	Record-Tape Service Cabinet .....	179
Monitor, Frequency .....	88	Relay Assemblies (Auxiliary) for Remote Control .....	99
Monitor, Master .....	74	Remote Amplifiers .....	163 thru 170
Monitor, Modulation .....	90	Remote Control Accessories .....	99
Monitor, Phase .....	93	Remote Control System, for Communications .....	230
Monitor, Video .....	74, 77, 81	Remote Control System, RDC-10C .....	95
Monitoring Amplifiers .....	162	Remote Control System, RDC-200 .....	97
Multiplex for FM Transmitters .....	58	Remote Control (Unattended) .....	95 thru 98
Nite Watch Automatic Programming Equipment .....	150	Remote Metering Kits .....	83
Open Wire Transmission Line .....	105	Remote Metering Panels .....	99
Oscillator/Amplifier, VFO-Crystal .....	230	RF Amplifier for FM Remote Control .....	99
		RF Amplifier for Remote Control .....	99
		RF Linear Amplifier, FAA .....	225

## INDEX

ITEM	PAGE	ITEM	PAGE
RF Pickup Coil and Rectifier .....	176	Transcription Turntable, CB-510, CB-525, 16-inch .....	133
Rheostats, Motor Tuned, for Remote Control .....	99	Transcription Turntable, CB-77, CB-88, CB-880, CB-99, 12-inch .....	136
Rhombic Antennas .....	107	Transformers .....	101
Rods, Grounds .....	106	Transformers, Loudspeaker Matching .....	180
Sampling Loops, Phase .....	84	Transmission Line, Air-Dielectric .....	106
Screen, Ground .....	107	Transmission Line, Heliax .....	106
Selective Amplifier .....	228	Transmission Line, Open Wire .....	105
Selectroslides, TV .....	79	Transmission Line, Solid Dielectric .....	106
Single Sideband Transceiver .....	219	Transmitters (Broadcast/AM)	
Slide Projectors for Television .....	79	100,000 Watt Model BC-100C Transmitter .....	12
Sockets, Tube .....	231	50,000 Watt Model BC-50C Transmitter .....	6
Solid Dielectric Coaxial Cable (RG Type) .....	106	20,000 Watt Model BC-20B Transmitter .....	14
Sound Effects Equalizers .....	174	10,000 Watt Model BC-10P Transmitter .....	18
Sound Effects Equipment .....	129	5,000 Watt Model BC-5P-2 Transmitter .....	22
Sound System, Auditorium .....	231	1,000 Watt Model BC-1T Transmitter .....	28
Speakers, Loud .....	178, 180	500 Watt Model BC-500T Transmitter .....	34
Speech Input Systems .....	110 thru 128	250 Watt Model BC-250T Transmitter .....	37
Splicers, Tape .....	181	250 Watt Model BC-250GY Transmitter .....	42
Spot Tape Recorder .....	140	Packaged Radio Stations, 1000 Watts, 500 Watts and 250 Watts .....	40
Sta-Level Amplifier .....	156	Transmitter Accessory Cabinet with Monitors, etc., Model GY-60B .....	87
Stands, Microphone .....	179	Transmitter Control Console .....	94
Strap, Ground .....	106	Transmitters, Conelrad for .....	41
Studioette Speech Input System .....	122	Transmitters (Broadcast/FM)	
Studio Warning Lights .....	179	10,000 Watt Model FM-10A Transmitter .....	44
Studio Wire .....	181	5,000 Watt Model FM-5B Transmitter .....	48
Stylus Force Gauge .....	181	1,000 Watt Model FM-1B Transmitter .....	52
Stylus, Recording .....	180	250 Watt Model FM-250B Transmitter .....	54
Switch and Fuse Panels .....	173	50 Watt Model BFE-50B Transmitter .....	56
Switcher, Model A-2532 .....	77	50 Watt FM Relay Transmitter, Model BFR-50C .....	228
Switcher-Fader Assemblies .....	74	10 Watt Educational Transmitter, Model BFE-10B .....	56
Synchronous Generator .....	78	FM Exciter .....	60
Tape, Cartridges .....	148	FM Multiplex .....	58
Tape, Eraser .....	181	Transmitters (Communications)	
Tape, Recording .....	187	100,000 Watt High Frequency Broadcast Transmitter .....	195
Tape Recorder, Cartridge (Cartritape) .....	144	50,000 Watt High Frequency Broadcast Transmitter .....	190
Tape Recorders .....	182	20,000 Watt Model HF-20 Transmitter .....	197
Tape Recorder, Spot .....	140	10,000 Watt Model HF-10 Telephone and Telegraph Transmitter .....	200
Tape Splicers .....	181	5,000 Watt Model HF-5 Telephone and Telegraph Transmitter .....	204
Telephone Pickup Coil .....	231	2,000 Watt VHF Doppler Transmitter .....	223
Television Cameras .....	71, 78	1,000 Watt Model HF-1M Transmitter .....	206
Television Control Console, Model TV-10 .....	126	1,000 Watt Model Police Transmitter, Model CMP-1 .....	211
Television Monitor, VHF-UHF .....	79	700 Watt CMW-1 Transmitter .....	215
Television System, EPS-21 .....	72	250 Watt, 2-channel Transmitter, Model M-3449Y .....	213
Television System, ETS-1 .....	75	250 Watt, Single Channel Transmitter, M-3491Y .....	214
Television Transmitters .....	61 thru 70	250 Watt Doppler Transmitter .....	223
Terminal Block, Audio .....	231	250 Watt Model CMG-1 Transmitter .....	209
Testers, Tube .....	230	65/85 Watt Transmitter/Exciter .....	217
Totalizing Recorder .....	227	65 Watt Modulator/Amplifier .....	218
Towers .....	108	50 Watt FM Relay Transmitter, Model BFR-50C .....	227
Tower Chokes .....	84	100 Watt Single Sideband Transceiver .....	219
Tower Light Flashers .....	107	50 Watt VHF AM Transmitter .....	226
Tower Lights .....	106, 107		
Tower Photo-Cell Units .....	107		
Transceiver (Citizens' Band) .....	229		
Transceiver, Single Sideband .....	219		
Transcription Pickups .....	138		
Transcription Turntable, CB-500, 16-inch .....	130		

**I N D E X**

ITEM	PAGE	ITEM	PAGE
Transmitters (Communications)—Con't.		Twinsistor 2-Channel Transistor Remote .....	166
UDOP Radio Frequency Reference System .....	221	UDOP Radio Frequency Reference System .....	221
Homing Beacom Transmitter .....	224	Uni-Cue Cueing Amplifier .....	161
UHF Command Transmitter .....	225	Unimote Single Microphone Remote .....	167
Transmitters (Television)		Utility Amplifier, Single Microphone .....	170
5,000 Watt Model BT-5C Transmitter .....	61	Vacuum Tube Voltmeter .....	230
500 Watt Model BT-500C Transmitter .....	66	Video Monitors .....	74, 77, 81
100 Watt Model BT-100A Transmitter .....	69	Video Processing Assembly .....	77
Transmute Single Microphone Transistor Remote .....	169	Volt-Ohm-Meters .....	230
Tripods, Camera .....	179	Volume Indicator Panels .....	173
Tubeless Tube Microphone Booster .....	169	Wall Baffles, Loudspeaker .....	180
Tube Sockets .....	231	Wire, Ground .....	106
Tube Testers .....	230	Yard Speech Input System .....	118
Turntable Equalizers .....	138		
Turntable, Presto .....	180		
Turntable, Transcription .....	130 thru 137		
Twin Generator .....	78		



**GATES RADIO COMPANY**

SUBSIDIARY OF HARRIS-INTERTYPE CORPORATION

**QUINCY, ILLINOIS**

**EXPORT DEPARTMENT**  
 13 East 40th Street  
 New York City  
 Cable Address: ARLAB

**IN CANADA**  
 Canadian Marconi Co.  
 Montreal, Quebec  
 and all principal Canadian Cities

**TELEPHONES**

Quincy, Ill. (Main Office)  
 BAldwin 2-8202

Houston, Texas  
 Stock-Carrying Branch  
 CApitol 8-8536

Washington, D.C.  
 MEtropolitan 8-0522

LITHOGRAPHED BY JOHN S. SWIFT, INCORPORATED ON HARRIS-SEYBOLD PRESSES



## PRICE LIST

(Effective July 1, 1960)

This is your price list for items listed in your Gates catalog. Each price has been carefully checked for accuracy. Rapidly changing conditions as well as the human element, will necessitate price changes or corrections from time to time. Therefore, the prices herein are subject to change without notice. — All prices are F.O.B. Quincy, Illinois. No charge is made for domestic packing. A small charge is made for export packing where overseas shipment is involved. Consistent with highest quality standards, we feel sure you will find the price on the items of your interest, both reasonable and fair.

CATALOG PAGE	FACTORY NUMBER	TYPE NUMBER	UNIT
--------------	----------------	-------------	------

Always Keep Price List In This  
Convenient Pocket



**GATES**

*Subsidiary of Harris-Intertype Corporation*

**QUINCY, ILLINOIS**





## TERMS AND CONDITIONS OF SALE

**PRICE PROTECTION** - Seller may adjust the price of any of the equipment covered by this order to seller's list price in effect immediately prior to shipment except that in the case of equipment manufactured by seller if (a) this order is accompanied by a downpayment of at least 25 percent of the total price of the equipment described herein and shipment is made within six (6) months after seller's acceptance of this order, or, (b) this order is herein designated as contingent upon issuance of a construction permit by the Federal Communications Commission and is accompanied by a downpayment of at least 5 percent of the total price of the equipment described herein and shipment is made within 9 (9) months after seller's acceptance of this order, no adjustment shall be made, other than as permitted herein under the provision entitled "Acceptance". If this order provides for deferred payment terms, seller may increase, but by not more than one percentage point, the rate of finance charge provided herein to its rate of finance charge in effect immediately prior to shipment.

**CONTINGENT ORDERS** - If this order is herein designated as being contingent, purchaser represents it has pending, or will file, with the F.C.C. an application for a construction permit. If such application as originally filed, or as amended, is denied, revoked, or abandoned, purchaser upon giving prompt written notice to that effect to seller, may cancel this order with respect to any or all items unshipped at the date of seller's receipt of said notice, whereupon seller shall refund to purchaser the balance of payments theretofore made for such cancelled items after deducting charges for special or custom-built equipment. If a balance remains payable to seller after deducting the price of such equipment, purchaser shall pay said balance upon receipt of invoice from seller.

**TAXES** - In addition to the purchase price, and following shipment, purchaser shall pay, or, within 10 days after receipt of invoice from seller, shall reimburse seller for, all sales, use, occupation, gross income, excise, documentary stamp, and other taxes, duties, tariffs, license fees and other charges levied, assessed, or imposed on purchaser, or at or after shipment of the equipment by seller, imposed on the equipment or required to be collected by seller by reason of, or on account of, the shipment, purchase, or sale of any article hereunder, or the execution of the contract or of notes or documents, or resulting from the transaction or any part thereof provided for herein.

**WARRANTY** - Seller warrants new equipment of its manufacture for one (1) year (six (6) months on moving parts) against breakage or failure of parts due to imperfection of workmanship or material, its obligation being limited to repair or replacement of defective parts upon return thereof, f.o.b. seller's factory, within the period aforesaid. Electron tubes shall bear only the warranty, if any, of the manufacturer thereof in effect at the time of shipment to purchaser. Other manufacturers' equipment covered by this order shall carry only such manufacturers' standard warranty.

Seller warrants that any new transmitter of its manufacture described herein, when properly installed by purchaser and connected with a suitable electrical load, will deliver the specified radio frequency power output at the output terminal(s) of the transmitter, but seller makes no warranty or representation as to the coverage or range of said apparatus. Seller's sole liability in the event said equipment does not so perform, or in the event that any of the equipment described herein does not conform to any statement herein relative to its operating characteristics or capabilities, shall be, at seller's option, either to demonstrate the operation of the equipment in conformance with the foregoing, or to replace it with equipment conforming with the foregoing, or to accept its return f.o.b. purchaser's point of installation and refund to purchaser all payments made thereon, without interest; provided, that seller shall have no responsibility to purchaser under the foregoing warranty unless purchaser shall give seller a written notice, within one (1) month after arrival of the equipment at purchaser's shipping point, that the equipment does not conform to said warranty.

**INSURANCE** - If this order provides for payment of the balance on deferred terms, purchaser will furnish to seller, prior to shipment, an insurance policy covering loss of or damage to the equipment in an amount equal to the full value of the equipment with a loss payable clause in favor of seller as its interest may appear.

**SHIPMENT** - Seller shall not be liable for any delay in, or inability to complete, the manufacture and shipment of the equipment, or installation of the tower and related equipment, on account of: labor difficulties; fires, casualties and accidents; acts of God; acts of the public enemy; transportation difficulties; inability to obtain equipment, materials or qualified labor sufficient to fill its orders; governmental interference or regulations; and causes beyond seller's control.

Subject to the foregoing, shipment on orders herein designated as contingent, shall be made by seller at such time, in seller's discretion, as its manufacturing scheduling and other conditions will permit.

**DAMAGES AND RISK OF LOSS** - Irrespective of any statement or specification herein as to the f.o.b. point of a shipment, purchaser assumes all responsibility for and risk of loss of, or damage to, the equipment upon shipment from seller's shipping point(s).

In no event shall seller be liable for anticipated profits, or for consequential damages, or for loss of use of the equipment or of any installation into which the equipment may be put.

There are no warranties, express, implied or statutory, and seller has made no representations and has, and shall have, no obligations or liabilities, whether on account of negligence or otherwise, other than as specified herein.

**TOWER AND RELATED EQUIPMENT OR SERVICES** - Tower erection work, ground system installation, installation of concrete foundations and anchors, and services related thereto and provided for herein, will be performed by an independent erector who shall not be deemed to be an agent of the seller.

With respect to the erection of the tower and related services, purchaser agrees that, (a) prior to shipment of the tower purchaser will have obtained from the F.C.C., the Civil Aeronautics Authority, and from any other governing bodies having jurisdiction thereof all necessary permits for the erection of the tower; (b) the erection of the tower on the proposed site will be in accordance with any building restrictions, zoning ordin-

ances, laws or governmental regulations; (c) the site will be level, clear and free from obstructions and debris, and staked off prior to arrival of the tower erection crew; (d) the site shall not consist of marshy land, swamps, dumps, rocky soil, peat or frozen soil, and the soil conditions shall be normal and suitable; (e) suitable electrical power will be available for construction work and for testing; and (f) there shall be suitable access to the site by truck and other vehicles for the hauling of all necessary materials and equipment.

The prices stated herein for tower erection and related work are based upon the presumed existence of the conditions above specified and also (g) upon normal weather conditions so that the work shall not be delayed by inclement weather; and (h) upon normal labor conditions and costs, including, but not limited to, the work not being delayed by strikes, lockouts or other labor difficulties and upon costs not being increased by the requirements of local unions for extra working or standby labor.

If either before or after the erection crew has begun the work of erection it is discovered that any of the conditions specified in (a) to (f), inclusive, do not obtain then the erection crew foreman in his discretion may have the crew, at the expense of the purchaser, perform such work as may be necessary or appropriate in order that the specified conditions may be brought about, or may delay the beginning of the work, or if already begun may discontinue the work, and if he considers it impracticable to keep the erection crew on the site, may have the crew depart from the site. All extra costs incurred by the erection contractor as the result of the nonexistence of any one or more of the conditions specified in (a) to (f), inclusive, including the work done by the erection crew in correcting any of said conditions, and any extra costs incurred by conditions (g) or (h) do not exist or continue to exist during the prosecution of the work, and the cost incurred by reason of the crew's leaving the site and later returning to the site when the required conditions shall obtain, as well as the cost of any extra materials or services requested of the erection crew foreman which are not called for in this order, shall be paid by purchaser, who hereby agrees to pay to the erection crew foreman, prior to departure of the erection crew from the site, an amount equal to such costs computed at the erection contractor's normal rates and prices.

Prior to the departure of the erection crew, purchaser will inspect the work, and if the work is in conformity with the terms and provisions of this order, purchaser shall accept the same and shall deliver to the erection crew foreman, at the time when the latter states to the purchaser that the work is complete, and, in any event, prior to departure of the crew, a signed statement of acceptance. If purchaser declines to sign such statement, then purchaser before departure of the crew, shall inform seller in detail by telephone of the reasons for such declination. If, before departure of the crew, purchaser fails so to notify seller, or if purchaser fails to make such inspection, the work shall be conclusively deemed to have been accepted by purchaser.

**RESERVATION OF TITLE** - The equipment ordered herein and any equipment added by amendments hereto is and shall always remain personal property irrespective of the installation thereof.

Upon request of seller, purchaser shall furnish to seller a waiver of landlord's lien or other lien upon the equipment.

Title to and right to repossession of the equipment shall remain in seller until the entire purchase price, whether represented by promissory notes, open account, judgment or otherwise, shall have been fully paid in cash.

**PAYMENT ARRANGEMENTS** - If this order provides for payment of the balance in deferred installments, purchaser, prior to shipment of the equipment, and at such time as requested by seller, will execute either a conditional sales contract or a chattel mortgage or other instrument of security, as designated by seller, and a promissory note, both in such form as shall be prescribed by seller, and will obtain such guarantees of payment as required by seller.

If in the judgment of seller, either before or after manufacture or shipment of the equipment, the financial responsibility of purchaser is such as to indicate inability to pay its obligations, including those hereunder, as they mature, seller upon giving written notice to purchaser may require payment in full or of a specified part of the balance of the purchase price within ten (10) days after the giving of such notice irrespective of the terms of payment stated herein.

**MISCELLANEOUS** - Purchaser agrees to indemnify seller against all claims, whether on account of negligence or otherwise, except those asserted by seller's employees, arising out of or resulting from the erection, operation or use of the equipment.

All prices are net. Prices on items manufactured by seller are f.o.b. Quincy, Illinois, and on equipment manufactured by others are f.o.b. point of shipment. In the absence of specific shipping instructions herein, the method of shipment and the carrier shall be selected by seller.

**ACCEPTANCE** - This proposal and acceptance when signed by purchaser shall constitute an order by purchaser, which shall be deemed to be accepted by seller when seller mails to purchaser its standard form of acknowledgment. Seller reserves the right to acknowledge to change prices and specifications herein to seller's prices and specifications in effect on the date of the acknowledgment. If the prices or specifications in the acknowledgment differ from those herein, purchaser may cancel this order by written notice by certified mail to seller within seven (7) days after receipt of the acknowledgment. In case of such cancellation, seller shall refund to purchaser the payments previously made on account of the purchase price, without interest. If written notice is not received from purchaser, as above provided, then such changes shall be deemed to be accepted. The order together with the acknowledgment above mentioned shall constitute the entire contract between the parties, and shall be changed only by written agreement of the parties. The banking of, or other use of the down payment, shall not constitute acceptance of this order by seller. The contract shall be governed by the laws of the State of Illinois.

Purchaser acknowledges receipt of a copy of this order as signed by it.



# PRICE LIST

(Effective July 1, 1960)

This is your price list for items listed in your Gates catalog. Each price has been carefully checked for accuracy. Rapidly changing conditions as well as the human element, will necessitate price changes or corrections from time to time. Therefore, the prices herein are subject to change without notice. — All prices are F.O.B. Quincy, Illinois. No charge is made for domestic packing. A small charge is made for export packing where overseas shipment is involved. Consistent with highest quality standards, we feel sure you will find the price on the items of your interest, both reasonable and fair.

CATALOG PAGE	FACTORY NUMBER	TYPE NUMBER	DESCRIPTION	UNIT PRICE
11	M5913	BC-50C	Broadcast transmitter, 50KW, with tubes	\$87,675.00
		TK367	Tube kit, 100% for BC-50C	6,170.75
		TK368	Tube kit, FCC spares for BC-50C	3,240.12
		A30866	Spare crystal and holder for BC-50C	70.00
13	M5967	BC-100C	Broadcast transmitter, 100KW, with tubes	(on application)
		TK376	Tube kit, 100% for BC-100C	(on application)
		TK377	Tube kit, FCC spares for BC-100C	(on application)
		A30866	Spare crystal and holder for BC-100C	70.00
17	M4779	BC-20B	Broadcast transmitter, 20KW, with tubes	39,985.00
			NOTE: Catalog states above as BC-20P, in error	
		TK229	Tube kit, 100% for BC-20B	2,068.00
		TK361	Tube kit, FCC spares for BC-20B	995.60
21	M5383	BC-10P	Broadcast transmitter, 10KW with tubes	16,995.00
		M6003	BC-10P	Broadcast transmitter, 10KW, with silicon dry rectifiers and tubes
	TK314		Tube kit, 100% for M5383 above	1,101.25
	TK315		Tube kit, FCC spares for M5383 above	576.10
	A30866		Spare crystal and holder for BC-10P	70.00
	26	M5565	BC5P-2	Broadcast transmitter, 5KW, with tubes
M5932			BC5P-2S	Broadcast transmitter, 5KW, with silicon dry rectifiers and tubes

CATALOG PAGE	FACTORY NUMBER	TYPE NUMBER	DESCRIPTION	UNIT PRICE
26 (cont'd)	M5190A	TK321	Tube kit, 100% for M5565 above	745.50
		TK322	Tube kit, FCC spares for M5565 above	497.00
		TK363	Tube kit, 100% for M5932 above	670.95
		TK364	Tube kit, FCC spares for M5932 above	460.23
		A30866	Spare crystal and holder for BC5P-2/S	70.00
	M5969		Complete extra cubicle for Conelrad and/or standby, with tubes	3,445.00
			Inbuilt Conelrad in BC5P-2/S transmitter	(on application)
32	M5393	BC-IT	Broadcast transmitter, 1KW, with tubes	4,595.00
		TK287	Tube kit, 100% for BC-IT	271.50
		TK288	Tube kit, FCC spares for BC-IT	136.95
		A30866	Spare crystal and holder for BC-IT	70.00
33	M5790	BC-IT	Broadcast transmitter, 1000/250 watts for Class IV operation, with tubes	4,670.00
			NOTE: For spare tubes and crystal, see prices Page 32 above.	
36	M5554	BC-500T	Broadcast transmitter, 500 watts, with tubes	4,125.00
		TK300	Tube kit, 100% for BC-500T	216.50
		TK307	Tube kit, FCC spares for BC-500T	78.08
		A30866	Spare crystal and holder for BC-500T	70.00
		M5614	Kit, to increase BC-500T to 1KW	459.00
39	M5627	BC-250T	Broadcast transmitter, 250 watts, with tubes	3,195.00
		TK306	Tube kit, 100% for BC-250T	154.10
		TK307	Tube kit, FCC spares for BC-250T	78.08
		A30866	Spare crystal and holder for BC-250T	70.00
		M5637	Kit, to increase BC-250T to BC-500T	1,130.00
		M5638	Kit, to increase BC-250T to BC-IT	1,670.00
40		GY-1000B	Packaged radio station	6,483.00
		GY-1000BRDC	Packaged radio station w/remote control	7,525.00
		GY-500B	Packaged radio station	6,018.00
		GY-500BRDC	Packaged radio station w/remote control	7,035.00
		GY-250B	Packaged radio station	5,088.00
		GY-250BRDC	Packaged radio station w/remote control	6,099.00
			NOTE: All packaged stations include tubes.	
			Conelrad	(on application)
41	M3760A	BC-250GY	Broadcast transmitter, 250 watts, with tubes	2,750.00
			Tube kit, 100% for BC-250GY	157.90
43	M3074	TK201	Tube kit, FCC spares for BC-250GY	91.76
		JK57M	Spare crystal and holder for BC-250GY	60.00

CATALOG PAGE	FACTORY NUMBER	TYPE NUMBER	DESCRIPTION	UNIT PRICE
47	M5833	FM-10A	Broadcast transmitter, 10,000 watts FM, with tubes	18,450.00
		TK349	Tube kit, 100% for FM-10A	1,349.48
		TK350	Tube kit, FCC spares for FM-10A	1,196.82
51	M5598	FM-5B	Broadcast transmitter, 5000 watts FM, with tubes	10,950.00
		TK313	Tube kit, 100% for FM-5B	756.80
		TK319	Tube kit, FCC spares for FM-5B	408.90
53	M5597	FM-1B	Broadcast transmitter, 1KW FM, with tubes	5,195.00
		TK312	Tube kit, 100% for FM-1B	164.00
		TK318	Tube kit, FCC spares for FM-1B	92.25
55	M5596	FM-250B	Broadcast transmitter, 250 watts FM, with tubes	3,150.00
	M5596	FM-250C	Broadcast transmitter, 250 watts FM, special frequency, with tubes (State frequency and bandwidth when ordering.)	3,390.00
		TK311	Tube kit, 100% for FM-250B and FM-250C	82.90
		TK317	Tube kit, FCC spares for FM-250B and FM-250C	72.05
57	M5595	BFE-50B	Broadcast transmitter, 50 watts FM, with tubes	1,695.00
		TK309	Tube kit, 100% for BFE-50B	45.95
		TK360	Tube kit, FCC spares for BFE-50B	32.45
	M5594	BFE-10B	Broadcast transmitter, 10 watts FM, with tubes	1,365.00
		TK308	Tube kit, 100% for BFE-10B	34.00
		TK359	Tube kit, FCC spares for BFE-10B	25.35
59	M5633A		Multiplex single sub-carrier with tubes	(on application)
	M5633B		Multiplex dual sub-carrier with tubes	(on application)
		TK383	Tube kit, 100% for M5633A	19.23
60	M5796	TK384	Tube kit, 100% for M5633B	27.91
			FM Exciter with tubes	1,195.00
		TK308	Tube kit, 100% for FM Exciter	34.00
65	M5491	BT-5CL	Television transmitter, 5000 watts, with tubes	35,995.00
		TK341	Tube kit, 100% for BT-5CL	1,437.63
		TK342	Tube kit, FCC spares for BT-5CL	886.32
	M5892		Optional color video filter with power supply	795.00
	M5777	BT-5CH	Television transmitter, 5000 watts with tubes	35,995.00
		TK343	Tube kit, 100% for BT-5CH	1,502.33
		TK344	Tube kit, FCC spares for BT-5CH	935.77
M5892		Optional color video filter with power supply	795.00	

CATALOG PAGE	FACTORY NUMBER	TYPE NUMBER	DESCRIPTION	UNIT PRICE
68	M5901	BT-500CL	Television transmitter, 500 watts, with tubes	17,750.00
		TK357	Tube kit, 100% for BT-500CL	372.15
	M5892	TK365	Tube kit, FCC spares for BT-500CL	240.27
			Optional color video filter with power supply	795.00
	M5902	BT-500CH	Television transmitter, 500 watts, with tubes	17,750.00
		TK358	Tube kit, 100% for BT-500CH	240.27
	M5892	TK365	Tube kit, FCC spares for BT-500CH	436.85
			Optional color video filter with power supply	795.00
70	M5364A	BT-100AL	Television transmitter, 100 watts, with tubes	6,150.00
		TK289	Tube kit, 100% for BT-100AL	257.65
	M5113A	TK372	Tube kit, FCC spares for BT-100AL	114.02
		BT-100AH	Television transmitter, 100 watts, with tubes	6,150.00
	TK354	Tube kit, 100% for BT-100AH	193.30	
	TK372	Tube kit, FCC spares for BT-100AH	114.02	
	JK07E	Spare crystal and oven (audio)	70.00	
	JK09E	Spare crystal and oven (visual)	65.00	
71	320-BV		Dage vidicon live camera, less lens	1,890.00
		320-BF	Dage film camera, less lens	1,275.00
	<b>LENSES FOR TV CAMERAS:</b>			
	A-069-2	1/2" f/1.5 wide angle	125.00	
	A-069-1	1" f/1.5 normal	98.00	
	A-1693	2" f/1.5 Elgeet	89.50	
	A-069-4	2" f/1.9 medium telephoto	88.00	
	A-1694	3" f/1.9 Elgeet	73.50	
	A-069-3	3" f/2.5 telephoto	88.00	
	A-1695	4" f/2.7 Elgeet with sunshade	88.95	
	A-069-5	4" f/4.5 telephoto	74.00	
	A-069-6	4" f/2.5 telephoto	189.95	
	A-069-7	6" f/4.5 telephoto	98.50	
	B-114-2	30-150mm remote control lens	1,800.00	
		Zoom lens, 1" to 4" manually operated, Pan Cinor	460.00	
	Zoom lens, 3/4" to 3" manually operated, Pan Cinor	410.00		
72	EPS-21		Dage TV system, less cameras	
			—with control for 1 camera	2,895.00
			—with control for 2 cameras	5,635.00
	—with control for 3 cameras	8,355.00		
74	C-466-1	Camera cable	\$60 + 75c/ft.	
	A-2482	Master monitor	1,000.00	
	A-2500	Video monitor	515.00	
	A-2541	Master waveform monitor	790.00	
	A-2576	Camera control & waveform monitor assembly	1,100.00	
	PC	Projector control	225.00	

CATALOG PAGE	FACTORY NUMBER	TYPE NUMBER	DESCRIPTION	UNIT PRICE
74 (cont'd)	521B	A-3966-2	Switcher-fader amplifier (includes parts A-2584-1 and A-3966-2)	845.00
75		ETS-1	Dage TV system, less camera —for single camera chain —for dual camera chain —for triple camera chain	4,022.00 5,096.00 5,705.00
77		A-2531 A-2530 A-2532	Camera control panel Video processing assembly Switcher	600.00 (on application) 345.00
78		431-A 431-B 334	Dage Twin-generator Dage Twin-generator Dage miniature TV camera	3,000.00 3,150.00 5,000.00
79		330A 330C 322A 322C 323 349 343 344 344A 345 348 335ER GR-973 GR-974 GR-975 GR-976 614CBVM 3B 35A 31L 31R 63A 62A	Selectroslide Selectroslide Selectroslide Selectroslide Spare turret Lens, Support Lens for Selectroslide Lens for Selectroslide Lens for Selectroslide Lens for Selectroslide Lens for Selectroslide VHF-UHF TV monitor Professional Junior spring head tripod Model B triangle Friction head tripod Carrying case Projector Telejector Manual control unit Additional turret Additional turret Mounting shelf Multiplexer	1,048.00 1,132.00 268.00 322.00 49.60 15.00 42.00 48.00 63.00 75.00 110.00 2,700.00 200.00 26.00 150.00 18.00 2,400.00 695.00 295.00 14.00 14.00 130.00 245.00
			<b>LENSES FOR TV CAMERAS:</b>	
		A-069-2	1/2" f/1.5 wide angle	125.00
		A-069-1	1" f/1.5 normal	98.00
		A-1693	2" f/1.5 Elgeet	89.50
		A-069-4	2" f/1.9 medium telephoto	88.00
		A-1694	3" f/1.9 Elgeet	73.50
		A-069-3	3" f/2.5 telephoto	88.00
		A-1695	4" f/2.7 Elgeet with sunshade	88.95
		A-069-5	4" f/4.5 telephoto	74.00
		A-069-6	4" f/2.5 telephoto	189.95
		A-069-7	6" f/4.5 telephoto	98.50
		B-114-2	30-150mm remote control lens	1,800.00
			Zoom lens, 1" to 4" manually operated, Pan Cinor	460.00
			Zoom lens, 3/4" to 3" manually operated, Pan Cinor	410.00

CATALOG PAGE	FACTORY NUMBER	TYPE NUMBER	DESCRIPTION	UNIT PRICE
80		44N3TVG	Spotlight	29.50
		44N6TVG	Spotlight	137.20
		44N8TVG	Spotlight	67.50
		44N12TVG	Spotlight	129.00
		1420CR	Floor stand	39.00
		1421CR	Floor stand	42.00
		44NP8G	Pole-Op	95.00
		44	Handle and loop	17.50
			100 watt bayonet base lamp	1.50
			150 watt bayonet base lamp	2.95
		order lamps by description as to the right	500 watt medium pre-focus lamp	5.50
			750 watt medium pre-focus lamp	6.60
			1000 watt mogul pre-focus lamp	7.10
			1500 watt mogul pre-focus lamp	12.10
			2000 watt mogul pre-focus lamp	14.35
			2000 watt mogul pre-focus lamp	14.00
		BP6	Kliegl light	58.75
		1365EG	Kliegl light	75.25
		1365EG-IRS	Kliegl light	122.50
		1366EG	Kliegl light	139.00
		1366EG-IRS	Kliegl light	406.00
		1174G	Kliegl light	629.00
		1178G	Kliegl light	44.50
		TV-1155G	Scoop light	46.00
		TV-111	Hanger	46.00
		TV-112	Hanger	70.50
		TV-113	Hanger	215.00
		963	Video patch panel	6.50
		965	Looping plug	6.50
		967A	Patch cord	6.75
		967B	Patch cord	
		for:	<b>LAMP SIZES:</b>	
		44N3TVG	100/150W bayonet base lamp	2.95
		44N6TVG	500/750W T20 medium pre-focus base lamp	6.60
		44N8TVG	1000, 1500, 2000W G40 mogul pre-focus lamp	12.10
		44NP8G	1000, 1500, 2000W G40 mogul pre-focus lamp	14.35
		44N12TVG	2000W G48 mogul pre-focus lamp	14.00
	81		TV monitor, 14" CMB	
			— C	585.00
			— R	575.00
		— N	505.00	
		TV monitor, 17" CMB		
		— C	590.00	
		— R	580.00	
		— N	510.00	
		TV monitor, 21" CMB		
		— C	630.00	
		— R	610.00	
		— N	530.00	
		CNA8/C	TV monitor, 8" in portable case	325.00
	CNA8/N	Chassis only	275.00	

CATALOG PAGE	FACTORY NUMBER	TYPE NUMBER	DESCRIPTION	UNIT PRICE
81 (cont'd)		CNA8/2R CLB	Rack assembly TV monitor, 14" rack mount	595.00 310.00
82	M5504 M5471	TV-100L TV-100H TV-500L TV-500H 1302 1304 1306 1308 1312	Antenna Antenna Antenna Antenna Multi-V antenna Multi-V antenna Multi-V antenna Multi-V antenna Multi-V antenna	1,600.00 1,600.00 2,500.00 2,275.00 550.00 1,150.00 2,400.00 3,200.00 7,800.00
			<b>JANPRO ANTENNAS:</b>	
		JA-2	(not listed in catalog) Power gain 1.8. Power rating 5KW or less	600.00
		JA-4	As listed in catalog	1,250.00
		JA-8	As listed in catalog	3,350.00
		JA-12	As listed in catalog	6,900.00
		JA-16	(not listed in catalog) Power gain 15.8. Power rating 55KW.	9,950.00
		FM-11	Broad band antenna	125.00
		FM-22	Broad band antenna Electric generating sets	335.00 (on application)
83	M5178 M5179 M5309A M5309B	44	Antenna coupler Antenna coupler Antenna coupler Antenna coupler Antenna coupler Antenna couplers, high power	335.00 175.00 175.00 595.00 875.00 (on application)
84	M3935 M3936 M3937 M3938		Tower choke Tower choke Tower choke Tower choke	60.00 81.50 95.75 115.00
		A-2100	Austin tower choke	303.00
		A-2101	Austin tower choke	313.00
		A-2102	Austin tower choke	303.00
		A-2103	Austin tower choke	313.00
		A-1970	Austin tower choke	338.00
		A-1971	Austin tower choke	354.00
		A-1972	Austin tower choke	338.00
		A-1973	Austin tower choke	354.00
	M3073		Isolation coil, includes M4561A coil	237.50
	M4561A		Isolation coil only	150.00
	M5634		Isolation unit, includes M5573 coil	195.00
	M5573		Isolation coil	110.00
	M3283		Phase sampling loop	115.00
	M3383		Remote metering kit	85.00
	M3133		Remote metering kit	85.00
	M3386		Remote metering kit	85.00
	M3294		Remote metering kit	75.00
	M3294B		Remote metering kit	75.00
	M3294D		Remote metering kit	75.00



CATALOG PAGE	FACTORY NUMBER	TYPE NUMBER	DESCRIPTION	UNIT PRICE
84 (cont'd)	M5334 M5335 M3759 M2765B		Remote metering kit Remote metering kit Diode only, less meter Diode only, less meter	79.50 79.50 70.00 82.00
85			Directional phasors	(on application)
87		GY-60B TK302	Complete accessory cabinet Tube kit	1,893.00 57.02
89	M4990  M5631 M5549	TK281	Frequency monitor with tubes Tube kit Remote frequency meter on panel Whip antenna and coupler	795.00 16.50 77.50 52.50
91	M5693  M5837	TK345	Modulation monitor, broadcast model with tubes Tube kit Remote meter panel NOTE: Catalog states M5834, which is error, Order M5837.	525.00 20.66 65.00
92	M5774  M5836B	TK346	Modulation monitor, high freq. model with tubes Tube kit Remote meter panel	720.00 32.71 65.00
93		108D 108E 108F 335BR 120D	Phase monitor Phase monitor Phase monitor FM monitor Field meter, less batteries	700.00 725.00 750.00 1,695.00 850.00
94	M4055	CCD2	Transmitter control console	850.00
96	M5862  M5876 M5877 M5878	RDC-10AC	Basic remote unit, 19 metering positions  NOTE: Above unit listed for special remote control requirements by using accessories on Page 99. Items B thru J are described and priced on Page 99. Item K standard equipment in RDC-10 models and not available separately. See M5145, Page 99, for separate tower light indicator. Complete remote control package, 250 watts Complete remote control package, 500 watts Complete remote control package, 1000 watts	796.00        961.00 961.00 966.00
98	M5870  M5145	RDC-200A	Remote control system, 40 metering positions Extra tower light indicator	1,550.00 19.95
99	M5270 M5631		Frequency monitor extension unit Extension meter, use with Gates M4990 monitor	225.00 77.50

CATALOG PAGE	FACTORY NUMBER	TYPE NUMBER	DESCRIPTION	UNIT PRICE
99 (cont'd)	M5144A		RF amplifier with tubes	295.00
	M5936		Automatic sequence switcher	125.00
	M4703-A		Motor/rheostat	100.00
	M4703-B		Motor/rheostat	100.00
	M4703-C		Motor/rheostat	105.00
	M5066		Tuning motor	85.00
	M5145		Tower light unit	19.95
	M5631		Remote meter and panel	77.50
	M5837		Remote meter only	65.00
	M5210		Monitor extension meter	60.00
	M5206		Monitor extension meter	65.00
	M5208		Monitor extension meter	65.00
	M5207		Monitor extension meter	65.00
	M5209		Monitor extension meter	65.00
	M3759		Antenna diode	70.00
	M2765B		Antenna diode	82.00
	M4801		Relay assembly	39.50
	M4806		Relay assembly	50.00
	M5249		Relay assembly	35.00
	M5248		Relay assembly	39.50
	M4719A		Plate voltage unit	13.95
M4848A		Output loading kit	173.00	
M4791		FM amplifier	295.00	
M4845		FM indicator	55.00	
M5129		Overload relay	32.50	
M4825		Rectifier	43.00	
M4720		Plate current unit	10.50	
M4800		Tuning motor assembly	85.00	
100	M5508		VHF dummy antenna (heat exchanger)	(on application)
	M3968	DU-551	Dummy antenna	215.00
	M3968A	DU-570	Dummy antenna	215.00
	M5343	DU-151	Dummy antenna	105.00
	M3483	DU-170	Dummy antenna	105.00
	M5645		Dummy antenna, air cooled	(on application)
			VHF dummy antenna	35.00
			Water cooled dummy antenna (all models)	(on application)
101			<b>TRANSFORMERS FOR 250 WATTS:</b>	
		BM-1	Modulation transformer	37.50
		BR-1	Modulation reactor	57.30
		BD-1	Driver transformer	20.70
		AP-7235	Power transformer	136.00
		CG-109	Swinging choke	27.00
		CG-105	Smoothing choke	15.00
			<b>TRANSFORMERS FOR 500 WATTS:</b>	
		AM-30613	Modulation transformer	178.00
		AC-10650	Modulation reactor	136.00
		AS-3172C	Driver transformer	177.45
		AP-12001E	Power transformer	149.00
		CG-109	Swinging choke	27.00
	CG-105	Smoothing choke	15.00	

CATALOG PAGE	FACTORY NUMBER	TYPE NUMBER	DESCRIPTION	UNIT PRICE	
101 (cont'd)			<b>TRANSFORMERS FOR 1000 WATTS:</b>		
		AM-30469	Modulation transformer	251.00	
		AC-10465	Modulation reactor	167.00	
		AS-3172C	Driver transformer	177.45	
		AP-10459E	Power transformer	194.00	
		AC-10458	Swinging choke	146.00	
		AC-10457	Smoothing choke	39.00	
			<b>TRANSFORMERS FOR 5000 WATTS:</b>		
		AM-7718E	Modulation transformer	765.00	
		AM-7718M	Modulation transformer	1,355.00	
		AC-7719E	Modulation reactor	605.00	
		AC-7719M	Modulation reactor	1,008.00	
		AP-8000E	Power transformer	577.50	
		AP-8000M	Power transformer	1,019.00	
		AC-3143E	Input or smoothing choke	104.00	
		AS-3172C	Driver transformer	177.45	
			<b>TRANSFORMERS FOR 10,000 WATTS:</b>		
	102		AM-30643	Modulation transformer	1,150.00
			AM-32886	Modulation transformer	1,670.00
			AC-3168E	Modulation transformer	835.00
		AC-32887	Modulation reactor	937.50	
		AS-3172C	Driver transformer	177.45	
		AP-3090E	Power transformer	1,190.00	
		AP-3090M	Power transformer	1,445.00	
		AC-3147E	Input or smoothing choke	200.00	
			<b>TRANSFORMERS FOR 20KW:</b>		
		AM-8674M	Modulation transformer	3,325.00	
		AC-8675M	Modulation transformer	2,800.00	
		AS-8672E	Driver transformer	205.00	
	AC-8673M	Filter reactor	830.00		
		<b>TRANSFORMERS FOR 50KW:</b>			
	AM-11788M	Modulation transformer	5,644.00		
	AC-11787M	Modulation reactor	5,224.00		
	AM-11788M	Driver transformer	5,644.00		
	AP-11785M	Power transformer	1,885.00		
	AC-11786	Filter reactor	1,129.00		
	AF-7782E	Filament transformer	57.00		
	AF-10434E	Filament transformer	136.00		
	AF-11856E	Filament transformer	146.00		
	AF-30099E	Filament transformer	94.00		
	AF-10432E	Filament transformer	136.00		
	AF-10456K	Filament transformer	41.00		
	AF-11857E	Filament transformer	232.00		
	AI-3002U	Audio input transformer	50.00		
	AI-10379T	Audio input transformer	18.00		
	AI-10386	Audio input transformer	18.00		
	AO-10427T	Audio output transformer	16.00		
	AO-10864T	Audio output transformer	20.00		
	114A	Audio repeater transformer	22.14		

CATALOG PAGE	FACTORY NUMBER	TYPE NUMBER	DESCRIPTION	UNIT PRICE	
103		87FA4634	Inductor	51.50	
		6FB0854	Inductor	31.25	
		10FB0855	Inductor	31.50	
		13FB0856	Inductor	32.50	
		18FB1754	Inductor	36.00	
		26FB1755	Inductor	36.50	
		35FB1756	Inductor	38.00	
		58FB2845	Inductor	45.75	
		78FB2846	Inductor	48.00	
		128FB4635	Inductor	61.50	
		6FC0854	Inductor	36.00	
		10FC0855	Inductor	34.00	
		13FC0856	Inductor	34.75	
		17FC1654	Inductor	42.25	
		24FC1655	Inductor	47.25	
		32FC1656	Inductor	46.00	
		42FC2266	Inductor	44.00	
		67FC2856	Inductor	71.50	
		78FC2568	Inductor	76.00	
		10FBT1066	Inductor	62.00	
		32FBT1658	Inductor	96.50	
		45FBT2158	Inductor	162.50	
		65FBT2559	Inductor	130.00	
		17FCT1178	Inductor	97.25	
		35FCT1779C	Inductor	155.50	
		6VC0854	Variable inductor	59.25	
		15VC1444	Variable inductor	58.25	
		26VC2144	Variable inductor	76.30	
		16VB1544	Variable inductor	55.25	
		30VB2344	Variable inductor	72.00	
		105VB3735	Variable inductor	73.90	
		LC4	Clip	.39	
		LC6	Clip	.68	
		LC8	Clip	.98	
		RC6	Clip	2.50	
		RC8	Clip	2.90	
		M3401F	Dial for variable coil	15.00	
		M5521	Dial for variable coil	30.00	
	104		order capacitors by description	<b>G1 MICA CAPACITORS:</b>	
				.00001 thru .00005 mfd.	22.92
		.0001 and .0002 mfd.		24.36	
		.0004 mfd.		26.61	
		.0005 mfd. and .001 mfd.		27.99	
		.00155 and .002 mfd.		29.34	
		.003 thru .005 mfd.		30.36	
		.006 thru .02 mfd.		30.90	
		<b>G2 MICA CAPACITORS:</b>			
		.0001 thru .005 mfd.		39.33	
		.006 thru .02 mfd.		41.49	

CATALOG PAGE	FACTORY NUMBER	TYPE NUMBER	DESCRIPTION	UNIT PRICE
104 (cont'd)			<b>G3 MICA CAPACITORS:</b>	
			.00005 mfd.	66.54
			.0001 mfd.	72.60
			.0002 thru .0003 mfd.	78.66
			.0005 thru .002 mfd.	84.23
			.003 thru .03 mfd.	90.75
			<b>G4 MICA CAPACITORS:</b>	
			.00003 and .00005 mfd.	100.74
			.0001 and .00015 mfd.	126.18
			.00025 thru .0008 mfd.	132.69
			.001 thru .003 mfd.	137.46
			.004 mfd.	140.61
			.005 mfd.	145.20
			.006 mfd.	151.35
			.008 mfd.	156.00
			.01 thru .04 mfd.	163.46
			<b>G5 MICA CAPACITORS:</b>	
			.00005 mfd.	265.80
			.0001 mfd.	278.40
			.00025 thru .0004 mfd.	302.40
			.0005 mfd.	326.40
			.001 mfd.	336.60
			.002 mfd.	322.80
			.0025 mfd.	328.80
			.003 thru .01 mfd.	340.80
			NOTE: Special values, not listed above, are available on special order at a price increase of 10% to the nearest value listed above. Approximately two weeks required for delivery. Orders for special values should be accompanied with a 20% deposit.	
			<b>F1 MICA CAPACITORS:</b>	
			All values .0001 thru .01 mfd.	7.56
			.02 and .05 mfd.	8.58
			0.1 mfd.	9.08
			<b>F2 MICA CAPACITORS:</b>	
			.00005 thru .05 mfd.	10.38
			0.1 mfd.	11.52
			0.2 mfd.	15.15
			0.25 mfd.	16.74
			<b>F3 MICA CAPACITORS:</b>	
			.00025 and .0005 mfd.	21.15
			.001 and .002 mfd.	23.55
			.005 mfd.	29.16

order capacitors by description

CATALOG PAGE	FACTORY NUMBER	TYPE NUMBER	DESCRIPTION	UNIT PRICE		
104 (cont'd)		order capacitors by description	.01 mfd.	33.12		
			.05 mfd.	37.11		
			0.1 mfd.	29.16		
			0.25 mfd.	26.76		
			0.5 mfd.	31.53		
			1.0 mfd.	49.11		
			<b>TYPE E MICA CAPACITORS:</b>			
			E-1245	.00005 mfd., 12,500V	10.80	
			E-1231	.00001 mfd., 12,500V	10.80	
			E-12325	.00025 mfd., 12,500V	10.80	
			E-1235	.0005 mfd., 12,500V	10.80	
			E-1221	.001 mfd., 12,500V	10.80	
			E-12215	.0015 mfd., 12,500V	12.60	
			E-1222	.002 mfd., 12,500V	15.00	
			E-1023	.003 mfd., 10,000V	16.20	
			E-1024	.004 mfd., 10,000V	17.40	
			E-1025	.005 mfd., 10,000V	19.44	
			E-721	.001 mfd., 7,000V	9.66	
E-722	.002 mfd., 7,000V	12.60				
E-723	.003 mfd., 7,000V	13.80				
E-711	.01 mfd., 7,000V	20.40				
E-3524	.004 mfd., 3,500V	12.60				
E-3525	.005 mfd., 3,500V	12.78				
E-3511	.01 mfd., 3,500V	19.44				
E-3512	.02 mfd., 3,500V	19.44				
E-3515	.05 mfd., 3,500V	22.56				
E-215	.05 mfd., 2,000V	19.32				
E-201	.1 mfd., 2,000V	22.56				
<b>TYPE H MICA CAPACITORS:</b>						
(priced on catalog page)						
<b>FILTER CAPACITORS:</b>						
	7106-2	2 mfd., 600V	4.29			
	7106-4	4 mfd., 600V	5.46			
	7106-8	8 mfd., 600V	8.10			
	7106-10	10 mfd., 600V	9.09			
	7110-2	2 mfd., 1000V	4.95			
	7110-4	4 mfd., 1000V	6.27			
	7110-8	8 mfd., 1000V	9.09			
	7110-10	10 mfd., 1000V	10.08			
	7120-2	2 mfd., 2000V	6.45			
	7120-4	4 mfd., 2000V	9.09			
	7120-8	8 mfd., 2000V	15.03			
	7120-10	10 mfd., 2000V	18.33			
	7130-2	2 mfd., 3000V	15.03			
	7130-4	4 mfd., 3000V	22.11			
	7130-8	8 mfd., 3000V	37.41			
	7140-2	2 mfd., 4000V	23.16			
	7140-4	4 mfd., 4000V	36.00			
	7140-6	6 mfd., 4000V	51.45			

CATALOG PAGE	FACTORY NUMBER	TYPE NUMBER	DESCRIPTION	UNIT PRICE
104 (cont'd)		7150-2	2 mfd., 5000V	30.60
		7150-4	4 mfd., 5000V	50.25
		7160-1	1 mfd., 6000V	29.40
		7160-2	2 mfd., 6000V	89.76
		7175-1	1 mfd., 7000V	65.19
		7175-2	2 mfd., 7000V	100.32
		TK70040	4 mfd., 7000V	150.48
105	M3327		Line bracket	31.50
	M3864		Center post assembly	18.50
	M3328		End plate	38.00
	M3322		Horn gap	48.00
	M2870-D		Feedthru bowl	13.95
	M3254		Feedthru bowl	13.95
	M5280 M5281		Feedthru bowl Feedthru bowl	9.00 9.00
106		RG-8U	Coaxial cable	per ft. .14
		RG-11U	Coaxial cable	" .13
		RG-17U	Coaxial cable	" .65
		RG-19U	Coaxial cable	" 1.12
		RG-20U	Coaxial cable (same as RG-19U but armored)—special price	" .65
		RG-22U	Coaxial cable	" .26
		H-O	Coaxial cable, Helix type	" 1.50
		H-I	Coaxial cable, Helix type	" 3.40
		20-T	End terminal, Helix	30.00
		21-R	End terminal, flange, Helix	50.00
		83	Air-dielectric coaxial cable	.80
		1701-GV	End terminal	12.00
		1701-P	End terminal	8.00
		1701-R	End terminal	10.00
		S-450	Air-dielectric coaxial cable	1.35
		1703AGV	End terminal	16.00
		1703-AP	End terminal	11.00
		1703-AR	End terminal	14.00
		451	Air-dielectric coaxial cable	90.00
		1211	Air-dielectric coaxial cable, any special length	(on application)
		1051-M	Right angle elbow	50.00
		1351	Gas inlet coupling	12.50
		T-1551	Clamp connector	15.00
		13942	End terminal	46.50
		GR-10	#10 soft drawn copper ground wire per lb.	.61
			NOTE: Copper ground wire prices will vary upward and downward in accordance with market.	
			Copper ground strap, 2" (for 100 ft. pkg.)	22.68
		Copper ground strap, 4" (for 50 ft. pkg.)	22.68	
	GR8R	Ground rod	4.35	
	GR24SC	Ground screen	51.00	
	878	Dry air pump	48.00	

CATALOG PAGE	FACTORY NUMBER	TYPE NUMBER	DESCRIPTION	UNIT PRICE	
106 (cont'd)		1910	Dehydrator, automatic	450.00	
		6600	Gas distribution manifold	14.00	
				(add \$12.00 per coax outlet)	
		OB-20	Single obstruction light	14.50	
		OB-21	Single obstruction light	14.50	
107		OB22-4	Double obstruction light	26.60	
		OB22P-4	Double obstruction light	30.00	
		KG114-3	Code beacon	293.35	
		RG114-4	Code beacon	293.35	
		100A21-TS	Replacement lamp	.42	
		111A21-TS	Replacement lamp	.42	
		500PS-40	Beacon lamp	2.50	
		620PS-40	Beacon lamp	2.50	
			Tower lighting kit, Spec. A1 (exposed wiring)		
			Kit 1E-2A, less photo-cell unit	80.00	
			Kit 1E-2AP, includes photo-cell unit	160.00	
			Tower lighting kit, Spec. A2 (exposed wiring)		
			Kit 2E1-2A, includes beacon flasher, less photo-cell unit	493.00	
			Kit 2E1-2AP, includes beacon flasher and photo-cell flasher LC-2074A	600.00	
			Tower lighting kit, Spec. A3 (exposed wiring)		
			Kit 3E1-4A, includes beacon flasher, less photo-cell unit	546.70	
			Kit 3E1-4AP, includes beacon flasher, and photo-cell unit LC-2074A	660.00	
			Tower lighting kit, Spec. A4 (conduit wiring)		
			Kit 4C2-6A, includes 2-circuit beacon flasher, less photo-cell unit	1,150.00	
			Kit 4C2-6AP, includes 2-circuit beacon flasher and photo-cell control LC-2072 or LC-2073	1,240.00	
	NOTE: Kits A2, A3 and A4 are shipped freight prepaid to common carrier shipping point nearest cus- tomer.				
	NOTE: Price per tower foot is for open wire connecting cable.				
	LC-2077	Flasher and photo-cell unit	247.20		
	LC-2076	Flasher and photo-cell unit	282.50		
	BF-31	Beacon flasher	60.00		
	BF-32	Beacon flasher	85.30		
	63305C	Photo-cell unit	55.00		
	63306C	Photo-cell unit	55.00		
	LC-2074	Flasher unit	158.90		
	LC-2072	Flasher unit	178.90		
	RTA-300	Rhombic antenna	440.00		
	RTL-300	Transmission line for Rhombic antenna	451.00		



CATALOG PAGE	FACTORY NUMBER	TYPE NUMBER	DESCRIPTION	UNIT PRICE
107 (cont'd)		TDL-340 DTA-430 DTL-400	Dissipation line for Rhombic antenna Doublet transmitting antenna Transmission line for Doublet	198.00 110.00 407.00
108			Utility towers	(price based on height & size)
113	M5236A		Dualux console with tubes	1,795.00
		TK294	Tube kit	56.50
	M5303		Intercom sub-station	16.00
	M5372		Desk	105.00
	M5304		Extra preamplifier	51.50
		AK-11939	Extra relay	13.50
115	M5133A		Gatesway console with tubes	1,475.00
		AK-11939	Extra relay	13.50
	M5303		Intercom sub-station	16.00
	M5371		Desk	97.50
		TK290	Tube kit	44.50
	M5304		Extra preamplifier	51.50
121	M5526		Yard console with tubes	1,095.00
		TK282	Tube kit	41.00
	M5304		Extra preamplifier	51.50
		AK-12626	Extra muting relay	13.50
	M5528		Desk (only available when purchased with Yard)	35.00
		A-30601	Speaker matching transformer	3.75
	M5303		Intercom sub-station	16.00
125	M5381		Studioette console with tubes	895.00
		TK270	Tube kit	28.25
	M5304		Extra preamplifier	51.50
		AK-12626	Extra muting relay	13.50
		A-30601	Speaker matching transformer	3.75
128	M5421A	TV-10	Television console with tubes	1,895.00
		TK295	Tube kit	56.30
	M5304		Extra preamplifier	51.50
129	M4309	CSE-9	Master preset console	(on application)
			Sound effects wagon, less loudspeaker	5,500.00
	M4364	LSB-2	Loudspeaker assembly	358.00
		TK155	Spare tube kit	66.40
132	M5739	CB-500	Transcription turntable	245.00
	M5739A	CB-500A	Transcription turntable	255.00
133	M5820	CB-510	Transcription turntable	385.00
	M5820A	CB-510A	Transcription turntable	412.50
	M5828	CB-525	Transcription turntable	449.00
	M5828A	CB-525A	Transcription turntable	480.00
	M5830		Stepdown transformer	15.00
	M5269	CAB-6	Cabinet only	90.00
135	M5274	CB-4	Desk	350.00
		CB-4M	Desk w/cutouts for CB-500 switches and wired	415.00
		CB-4N	Desk w/two CB-510A turntables wired	1,217.50

CATALOG PAGE	FACTORY NUMBER	TYPE NUMBER	DESCRIPTION	UNIT PRICE
135 (cont'd)		CB-4P	Desk w/two CB-500 turntables, uses Gray 108-C arms (106-SP listed in catalog in error)	1,167.00
		CB-4R	Desk equipment w/console	2,693.00
		CB-4S	Desk equipment w/console	2,642.00
			NOTE: Models CB-4P and CB-4S do not include preamplifiers for pickups. If preamplifiers desired, order M5530, Page 170.	
137	M5798	CB-77	Transcription turntable	225.00
	M5798A	CB-77-50	Transcription turntable	235.00
	M5890	CB-88	Transcription turntable	366.00
	M5890A	CB-88A	Transcription turntable	382.00
	M5943	CB-99	Transcription turntable	867.00
	M5943A	CB-99A	Transcription turntable	899.00
	M5941	CB-880	Transcription turntable	441.00
	M5941A	CB-880A	Transcription turntable	457.00
	M5937	CAB-8	Single chassis cabinet only	75.00
	M5938	DTT-2	Dual chassis cabinet only	135.00
138		108C	Transcription arm	39.95
		212	Transcription arm	36.50
		602C	Equalizer	57.50
		4G-050	Pickup cartridge	9.95
		4G-052	Pickup cartridge	19.95
		4G-053	Pickup cartridge	30.95
		4G-040	Pickup cartridge	7.50
		4G-041	Pickup cartridge	7.50
		4G-061	Pickup cartridge	17.95
		4G-063	Pickup cartridge	17.95
		4GD-01S-02S	Pickup cartridge	12.95
		4GD-01D-02D	Pickup cartridge	22.50
		4GD-01D-02D	Pickup cartridge	33.50
		4GS-01D	Pickup cartridge	20.50
		4GS-02D	Pickup cartridge	20.50
		4GS-01S	Pickup cartridge	10.50
		4GS-02S	Pickup cartridge	10.50
		4G-01S	Pickup cartridge	2.00
		4G-02S	Pickup cartridge	2.00
		4G-03S	Pickup cartridge	2.00
		4G-01D	Pickup cartridge	9.95
		4G-02D	Pickup cartridge	9.95
		4G-03D	Pickup cartridge	9.95
		RPJ-01S	Pickup cartridge	2.00
		RPJ-02S	Pickup cartridge	2.00
		RPJ-03S	Pickup cartridge	2.00
		RPJ-01D	Pickup cartridge	9.95
		RPJ-02D	Pickup cartridge	9.95
		RPJ-04D	Pickup cartridge	10.50
		RPJ-005	Pickup cartridge	2.10
		RPJ-006	Pickup cartridge	2.10
		RPJ-001	Pickup cartridge	2.10
		RPJ-004	Pickup cartridge	10.50
	RPJ-002	Pickup cartridge	10.50	
	RPJ-003	Pickup cartridge	10.50	

CATALOG PAGE	FACTORY NUMBER	TYPE NUMBER	DESCRIPTION	UNIT PRICE
138 (cont'd)		A1-504 RKP-009B GC-5	Adapter Replacement parts kit Stereo w/diamond .5 stylus	.73 .30 26.95
139	M5235	TK225	Preamplifier, equalized, with tubes	79.50
	M5530		Tube kit	2.56
	M5635		Preamplifier, 3-stage utility, with tubes Cue Sta-Level patch cabinet	89.50 410.00
143	M5735	ST-101 TK351	Spot Tape recorder Tube kit	995.00 8.75
	M5840		Extra tape roll	28.75
147	M5944		Cartritape playback unit	520.00
	M5944A		Cartritape playback unit	520.00
	M5952		Recording panel	345.00
	M5952A		Recording panel	345.00
	M5953		Switcher	134.50
	M5953A		Switcher	134.50
	M5960		Remote panel	39.75
	M5965		Mounting box	6.50
148		F-300	Automatic tape cartridge	2.20
		F-300A	Automatic tape cartridge	2.95
		F-300B	Automatic tape cartridge	2.95
		F-300C	Automatic tape cartridge	3.50
		F-300D	Automatic tape cartridge	3.90
		F-300E	Automatic tape cartridge	4.73
		F-300G	Automatic tape cartridge	5.00
		F-600	Automatic tape cartridge (empty/no tape)	3.25
		F-600H	Automatic tape cartridge	6.75
		F-1200	Automatic tape cartridge (empty/no tape)	4.70
		F-1200J	Automatic tape cartridge	14.00
		F-1200K	Automatic tape cartridge	17.24
		V-300	Viking cartridge (empty/no tape)	2.75
		V-1200	Viking cartridge (empty/no tape)	4.16
149	M5452		Auto-Trans	895.00
152	M5671		Nite-Watch automatic programming unit	2,945.00
	M5628		Nite-Watch, less cabinet for recorder	2,895.00
	M5664		Recorder panel	97.50
	M5665		Auto-Trans control switch box	22.50
153	M5429		Auto-Station complete with production unit and automatic playback unit	5,975.00
155	M3529B	SA-39B TK-150	Limiting amplifier with tubes Tube kit	425.00 19.86
157	M5167	TK-243	Sta-level with tubes Tube kit	242.50 15.00
160	M5546	TK-331	Level Devil program amplifier Tube kit	325.00 19.45

CATALOG PAGE	FACTORY NUMBER	TYPE NUMBER	DESCRIPTION	UNIT PRICE
160 (cont'd)	M5881		Balanced set of (2) 5749 and (1) 12AU7 tubes, includes charge for testing and selecting	16.75
161	M5377		UniQue, rack mount	115.00
	M5377A		UniQue, desk mount	99.50
		TK305	Tube kit	2.35
	M5576		Program amplifier with tubes	165.00
		TK304	Tube kit	7.25
	M5575		Monitoring amplifier with tubes	189.00
		TK303	Tube kit	14.45
		A-30601	Speaker matching transformer	3.75
164	M4880-A		Dynamote with XL connectors and tubes	375.00
	M4880-B		Dynamote with P connectors and tubes	394.00
	M4933		Continumatic battery compartment	45.00
		TK183	Tube kit	7.31
	M5983		Spare batteries	8.85
		XL3-12	Microphone plug, Cannon	.99
		P3CG-12S	Microphone plug, Cannon	3.40
165	M5136		Biamote remote amplifier with tubes	215.00
		XL3-12	Microphone plug, Cannon	.99
		TK183	Tube kit	7.31
166	M5168		Twinsistor remote amplifier	215.00
			NOTE: If carrying case not desired, deduct \$4.95.	
		XL3-12	Microphone plug, Cannon	.99
	M5339		Battery kit	12.75
	M5332		Microphone with swivel	44.65
		XL3-12	Microphone plug, Cannon	.99
		XL3-11	Output connector, Cannon	1.03
	M5350		Battery kit	2.25
167	M5531		Unimote remote amplifier with tubes	105.00
		XL3-12	Microphone plug, Cannon	.99
		TK280	Tube kit	5.50
168	M5500		Automote remote amplifier with tubes	195.00
		XL3-12	Microphone plug, Cannon	.99
	M5339		Battery kit	12.75
		XX30	Relay battery	2.75
169	M5311		Transmote with carrying case	145.00
	M5311-A		Transmote, less carrying case	136.75
	M5339		Battery kit	12.75
		XL3-12	Microphone plug, Cannon	.99
	M5312		Tubeless tube	39.75
	M5350		Battery kit	5.50
170	M5530		All-purpose utility amplifier with tubes	89.50
		TK280	Tube kit	5.50
		XL3-13	Chassis connector, Cannon	1.03
		XL3-12	Microphone plug, Cannon	.99

CATALOG PAGE	FACTORY NUMBER	TYPE NUMBER	DESCRIPTION	UNIT PRICE	
171 (cont'd)	M4174	PRE-4	Preamplifier with tubes	79.00	
		TK112	Tube kit	3.50	
	M4176	PGM-4	Program amplifier with tubes	105.00	
		TK122	Tube kit	5.44	
	M3982	PAS-1	Bridging controls (all models) Panel and shelf assembly	6.50 29.50	
			NOTE: For special color, add \$2.00.		
	M4618	BA-20	Base and receptacle	5.95	
	M4619	BA-21	Base and receptacle	6.25	
172	M4175	MON-4	Monitoring amplifier with tubes	117.50	
		TK121	Tube kit	6.89	
	M5000	PWR-3	Power supply	89.00	
		TK103	Spare tube kit	11.85	
	M4453	PWR-10	Bias supply	9.25	
	M4619	BA-21	Base and receptacle	6.25	
173	M4577	V-22	Volume indicator panel	108.25	
	M4242	SFP-1	Switch and fuse panel	38.50	
		PJ-343	Jack strip	25.14	
		PJ-341	Jack strip	42.75	
		M4399	PD-1	Jack mat	8.75
		M4400	PD-2	Jack mat	8.75
		M4401	PD-3	Jack mat	8.75
			PJ-12	Patch cord	7.41
			PJ-13	Patch cord	7.59
			PJ-14	Patch cord	7.86
			PJ-15	Patch cord	8.07
	174	M3664	SA-116	Equalizer	90.00
M3665		SA-117	Equalizer	90.00	
M3666		SA-118	Equalizer	90.00	
M3667		SA-119	Equalizer	85.00	
M3668		SA-120	Equalizer	80.00	
M3669		SA-121	Panel to mount equalizer	10.00	
M4391		LE-1	Equalizer	25.00	
M4392		LE-2	Equalizer	91.00	
M4389		FSE-1	Equalizer	145.00	
M4390		FSE-2	Equalizer	145.00	
175	M3706	RAK-1	Rack cabinet	120.00	
	M3708	TRM-1	Single corner trim	10.00	
	M3707	TRM-2	Double corner trim	11.00	
	M3709	SP-1	Side panel	19.00	
	M3710	SH-1	Shield	5.50	
	M3711	SH-2	Shield	6.25	
	M3712	BRK-1	Terminal board mounting bracket	3.40	
	M4875	RAK-F-1	Ventilating fan	39.50	
	M5527	RAK-7	Rack cabinet	85.00	
	M5577		Joiner trim	12.50	
176		200	Audio oscillator	138.00	
		400	Noise and distortion meter	168.00	
	M3625		Gain and measuring set	165.00	
	M3663	SA-131	Complete proof of performance package	513.00	
	M3626		Rectifier/pickup coil	42.00	

CATALOG PAGE	FACTORY NUMBER	TYPE NUMBER	DESCRIPTION	UNIT PRICE	
177 (cont'd)		665	Microphone	90.00	
		664	Microphone	51.00	
		655C	Microphone	120.00	
		654	Microphone	60.00	
		636	Microphone	43.50	
		623	Microphone	34.20	
		635	Microphone	49.20	
		647	Microphone	49.50	
		315	Microphone	53.70	
		556S	Microphone	81.00	
	639	Microphone	250.00		
178			<b>SPEAKER CABINETS:</b>		
			"The Empire" mahogany	99.00	
			"The Empire" limed oak or walnut	109.00	
			"The Aristocrat" mahogany	72.00	
			"The Aristocrat" limed oak or walnut	79.00	
			"The Baronet" mahogany	45.00	
			"The Baronet" limed oak or walnut	49.00	
		15TRX	Loudspeaker	149.00	
		15TRXB	Loudspeaker	79.00	
		SP12	Loudspeaker	66.00	
		848	Loudspeaker	49.50	
		847	Loudspeaker	30.60	
		SP8B	Loudspeaker	29.50	
		345	Shock mount	9.00	
		346	Shock mount	9.00	
		366	Shock mount	24.00	
		300	Clamp	6.00	
		524	Wind screen	4.80	
		335	Blast filter	3.30	
		418	Desk stand	6.00	
		418S	Desk stand	9.00	
		419	Desk stand	6.00	
		419S	Desk stand	9.00	
		420	Desk stand	12.00	
		423A	Desk stand	3.00	
		428	Desk stand	10.50	
	179		CS-33	Floor stand	8.10
			DS-7	Desk stand	3.00
			TS-6	Banquet stand	5.40
			MS-25	Floor stand	15.60
			MS-10C	Floor stand	5.85
			BB-1	Boom bracket	4.50
		BS-36	Boom stand	37.80	
		BS-36W	Boom stand	43.80	
		AM-1	Studio warning light	19.00	
		AM-2	Studio warning light	19.00	
		AM-3	Studio warning light	19.00	
		AM-5	Studio warning light	19.00	
		AM-4	Studio warning light, "On Air"	16.60	
		RB-89	Clock (includes tax)	14.25	
	602	Clock (includes tax)	18.65		
	QT-7	Studio warning light, "On Air"	19.00		

CATALOG PAGE	FACTORY NUMBER	TYPE NUMBER	DESCRIPTION	UNIT PRICE	
179 (cont'd)	M5611	BA-200	Record-tape service cabinet	19.95	
		BA-201	Dual head set	15.00	
		107	Single head set	9.95	
		35-3	Trim dual head set	6.60	
			Trim head set	20.40	
180		1203A	Loudspeaker	19.95	
		A1-406B	Speaker cabinet	64.95	
		A1-406M	Speaker cabinet	64.95	
		A1-406U	Speaker cabinet	56.20	
		A1-412	Speaker cabinet	37.95	
		A1-411	Speaker cabinet	35.95	
		A1-414	Speaker cabinet	32.95	
		DWB-12	Wall baffle	8.40	
		DWM-12	Wall baffle	8.40	
		C12A-B	Corner baffle	10.95	
		C12A-M	Corner baffle	10.95	
		A18-A	Ceiling baffle	7.29	
		6N	Disc recorder	1,245.00	
		6NP	Disc recorder	1,323.50	
		6NC	Disc recorder	1,383.50	
		32M	Microgroove feed screw	76.50	
		A-93	Recording amplifier	420.00	
		ID-16	Cutting head	269.00	
		ID-500	Cutting head	269.00	
			Recording stylus (all types)	4.95	
		ZY-2002	Speaker matching transformer	4.95	
		ZY-4004	Speaker matching transformer	4.95	
		ZY-2003	Speaker matching transformer	5.95	
		P8S	Jensen speaker	6.81	
		PI0T	Jensen speaker	6.45	
		PI2T	Jensen speaker	7.08	
		TT4	Bogen-Presto turntable with standard motor	99.50	
		TT5	Bogen-Presto turntable, same as TT4 but hysteresis motor	129.50	
			NOTE: Catalog refers to TT4 as T68AH, which is error. Correct T68AH is listed at bottom of column 3, Page 180.		
			T68AH	Turntable	170.00
	181		HD-11	Tape eraser	23.38
			255	Chair	65.00
			A-7	Disc cabinet	25.50
		B-10	Disc cabinet	28.50	
		C-12	Disc cabinet	37.50	
		D-16	Disc cabinet	51.00	
		SR-420	Film separator	8.00	
		SR-6820	Film separator	8.75	
		SR-1216	Film separator	9.50	
		TR-742	Tape cabinet	15.75	
		TR-1021	Tape cabinet	11.55	
		F50-6120	Film cabinet	90.00	
		RM-77	Film Reel-Mobile	89.25	

CATALOG PAGE	FACTORY NUMBER	TYPE NUMBER	DESCRIPTION	UNIT PRICE
181 (cont'd)		DM-360X	Disc Reel-Mobile	183.00
		C-540	Disc cabinet	240.00
		301	Stylus gauge	1.50
		602C	Equalizer	57.50
		TS4H	Tape Splicer	8.65
			Industrial tape splicer (all models)	55.00
		SH-20	Shielded two conductor wire	
			— less than 1000 ft. (per ft.)	.051/2
			— per 1000 ft. spool	50.00
		8440	Shielded wire	
			— 100 ft. package	4.60
			— 500 ft. package	19.95
			— 1000 ft. package	39.75
		1261	Shielded wire	
			— 250 ft. package	11.97
		— 500 ft. package	22.05	
		— 1000 ft. package	44.10	
	8428	Shielded wire		
		— 50 ft. package	5.40	
		— 100 ft. package	10.50	
	MIC-100	Microphone cable	(per ft.)	.08
	8410	Microphone cable	(per ft.)	.09
183			<b>AMPEX SERIES 300 (ALL 7 1/2"—15")</b>	
	7425-01		Single channel Model 300-U, uncased 1/4" tape, full track	2,150.00
	7425-03		Single channel Model 300-C console, 1/4" tape, full track	2,250.00
	30902-01		Two channel Model 300-2U, uncased, 1/4" tape, two tracks	3,490.00
	30902-03		Two channel Model 300-2C console, 1/4" tape, two tracks	3,815.00
	30903-01		Three channel Model 300-3U, uncased, 1/2" tape, three tracks	4,374.00
	30903-03		Three channel Model 300-3C console, 1/2" tape, three tracks	4,698.00
	30903-05		Three channel with Sel-Sync, uncased, Model 300-3SSU, 1/2" tape	4,800.00
	30903-07		Three channel with Sel-Sync, console, Model 300-3SSC, 1/2" tape	5,124.00
	30904-01		Four channel with Sel-Sync, uncased, Model 300-4SSU, 1/2" tape	5,576.00
	30904-03		Four channel with Sel-Sync, console, Model 300-4SSC, 1/2" tape	5,900.00
			NOTE: All above, 60 cycle models. No extra charge for 50 cycles when specified.	
185			<b>AMPEX 351-U SERIES (NAB CURVE)</b>	
	30700-13		Uncased, 3 3/4"—7 1/2" full track	1,475.00
	30700-1		Uncased, 7 1/2"—15" full track	1,475.00
	30700-19		Uncased, 3 3/4"—7 1/2" half track	1,475.00
	30700-07		Uncased, 7 1/2"—15" half track	1,475.00



CATALOG PAGE	FACTORY NUMBER	TYPE NUMBER	DESCRIPTION	UNIT PRICE
185 (cont'd)			<b>AMPEX 351-P SERIES (NAB CURVE)</b>	
		30700-17	Two case portable, 3 $\frac{3}{4}$ "—7 $\frac{1}{2}$ " full track	1,575.00
		30700-05	Two case portable, 7 $\frac{1}{2}$ "—15" full track	1,575.00
		30700-23	Two case portable, 3 $\frac{3}{4}$ "—7 $\frac{1}{2}$ " half track	1,575.00
	30700-11	Two case portable, 7 $\frac{1}{2}$ "—15" half track	1,575.00	
			<b>AMPEX 351-C SERIES (NAB CURVE)</b>	
		30700-15	Console model, 3 $\frac{3}{4}$ "—7 $\frac{1}{2}$ " full track	1,625.00
		30700-03	Console model, 7 $\frac{1}{2}$ "—15" full track	1,625.00
		30700-21	Console model, 3 $\frac{3}{4}$ "—7 $\frac{1}{2}$ " half track	1,625.00
		30700-09	Console model, 7 $\frac{1}{2}$ "—15" half track	1,625.00
		652	Portable in case, 7 $\frac{1}{2}$ " half track	595.00
		654	Portable in case, 7 $\frac{1}{2}$ " full track	595.00
		656	Portable in case, 3 $\frac{3}{4}$ " half track	625.00
		658	Portable in case, 3 $\frac{3}{4}$ " full track	625.00
		662	Uncased model, 7 $\frac{1}{2}$ " half track	545.00
		664	Uncased model, 7 $\frac{1}{2}$ " full track	545.00
		666	Uncased model, 3 $\frac{3}{4}$ " half track	575.00
		668	Uncased model, 3 $\frac{3}{4}$ " full track	575.00
		620	Ampex amplifier-speaker	189.50
186		938C	Telectro recorder	1,340.00
		938R	Telectro recorder	1,150.00
		938P	Telectro recorder	1,300.00
187		M-90ACC	Magnecord recorder in new metal console cabinet	1,495.00
		M-90AC	Magnecord recorder/amplifier with case	1,405.00
		M-90ACX	Magnecord recorder/amplifier, less case	1,295.00
		91X3319	Portable case for recorder	70.00
		81050	Portable case for amplifier	40.00
		M-90BAC	Binaural model in portable case (not listed in catalog)	2,255.00
		M-90BACX	Binaural model, less case (not listed in catalog)	2,105.00
		727AX	Magnecord recorder (not listed in catalog) (new type number P75-AX)	535.00
		727BX	Magnecord recorder (not listed in catalog) (new type number P75-CX)	265.00
		PT63-A2HZ	Magnecord recorder in case	495.00
		PT63-A2HZX	Recorder, less case	450.00
		91X3318	Case	45.00
		PT63-J	Recorder-playback amplifier	390.00
		PT63-JX	Recorder, less case	345.00
		91X1890	Case	45.00
188		PT6-6A	Magnecord recorder	405.00
		PT6-6AX	Magnecord recorder	375.00
		7A	Carrying case for recorder	30.00

CATALOG PAGE	FACTORY NUMBER	TYPE NUMBER	DESCRIPTION	UNIT PRICE
188 (cont'd)		PT6-6J	Magnecord recorder	295.00
		PT6-6JX	Magnecord recorder	265.00
		7C	Amplifier case	30.00
		728-4X	Magnecord recorder (uncased)	759.00
		728-4	Magnecord recorder, with case	809.00
		S36-BX	Tape recorder rack mount	385.00
		S36-B	Rack mount in case	415.00
		111-1.5	Recording tape	.47
		111-3	Recording tape	.90
		111-6	Recording tape	1.50
		111-12	Recording tape	2.34
		111-24H	Recording tape	5.67
		111-24R	Recording tape	7.27
		111-48H	Recording tape	11.33
		111-48R	Recording tape	14.73
		120A-6	Recording tape	2.34
		120A-12	Recording tape	3.67
		190-9	Recording tape	2.34
		190-18	Recording tape	3.67
		190-36R	Recording tape	8.57
		190-36H	Recording tape	6.67
		190-72R	Recording tape	17.33
		190-72H	Recording tape	13.33
		150-9	Recording tape	2.40
		150-18	Recording tape	4.13
		150-36H	Recording tape	8.00
		150-36R	Recording tape	9.60
		150-72H	Recording tape	16.00
		150-72R	Recording tape	20.00
		200-24	Recording tape	6.33
		200-48R	Recording tape	14.67
		41-1/2S	Recording tape	.39
		43-1.5	Recording tape	.60
		200	Recording tape	6.00
		GR-LST	Recording tape	12.50
		RB-3	Recording tape	.17
		RB-4	Recording tape	.37
		RB-5	Recording tape	.44
		RB-7	Recording tape	.50
		RB-10 1/2 M	Recording tape	3.00
194	M5481	HF-50C	Broadcast transmitter, 50KW	(on application)
		TK367	Tube kit, 100% for HF-50C	(on application)
		TK368	Tube kit, FCC spares for HF-50C	(on application)
		JK-02C,H17	Spare crystal and holder for HF-50C	(on application)
196	M5966	HF-100C	Broadcast transmitter, 100KW	(on application)
		TK376	Tube kit, 100% for HF-100C	(on application)
		JK-02,H17	Spare crystal and holder for HF-100C	(on application)
199	M4748	HF-20B	Broadcast transmitter, 20KW	41,500.00
	M4748A	HF-20B	Broadcast transmitter, 20KW	41,500.00
	M4778	HF-20BX	Broadcast transmitter, 20KW	41,750.00
	M4778A	HF-20BX	Broadcast transmitter, 20KW	41,750.00
	M4780	HF-20TX	Telegraph transmitter, 20KW	22,900.00

all transmitters include tubes

CATALOG PAGE	FACTORY NUMBER	TYPE NUMBER	DESCRIPTION	UNIT PRICE
199 (cont'd)	M4780A	HF-20TX JK-03,H17 TK139 TK140	Telegraph transmitter, 20KW Crystal and holder Tube kit Tube kit <i>all transmitters include tubes</i>	22,900.00 34.60 2,067.00 1,078.00
202	M3787	HF-10B	Broadcast transmitter, 10KW, with oil-filled external transformers, for 60 cycles. Shipping wt.: 10,700 lbs. Cubage: 551.	24,059.00
	M3787A M3787C	HF-10B HF-10B	Same as above but for 50 cycles Broadcast transmitter, 10KW, with dry type external transformers, for 60 cycles. Shipping wt.: 7000 lbs. Cubage: 492.	24,059.00
	M3787D M3789	HF-10B HF-10BX	Same as above but for 50 cycles Broadcast transmitter, 10KW, same as M3787, with keying, for 60 cycles	22,500.00 22,500.00
	M3789A	HF-10BX	Broadcast transmitter, 10KW, same as M3789, with keying, for 50 cycles	24,459.00
	M3789B	HF-10BX	Broadcast transmitter, 10KW, same as M3787C, with keying, for 60 cycles and dry external transformers	24,459.00
	M3789C	HF-10BX	Broadcast transmitter, 10KW, same as M3789B but for 50 cycles	22,900.00
	M3791	HF-10C	Communications transmitter, 10KW	21,500.00
	M3791A	HF-10C	Communications transmitter, 10KW	21,500.00
	M3793	HF-10CX	Communications transmitter, 10KW	21,900.00
	M3793A	HF-10CX TK255 TK253 TK256	Communications transmitter, 10KW HF-TSX-10 tube set* HF-TSB-10 tube set HF-K tube set	21,900.00 611.00 1,141.50 5.65
203	M3795 M3795A	HF-10TX HF-10TX TK255	Telegraph transmitter, 10KW Telegraph transmitter, 10KW Tube kit	15,985.00 15,985.00 611.25
	M3794 M3794A	HF-5TX HF-5TX TK254	Telegraph transmitter, 5KW Telegraph transmitter, 5KW Tube kit	15,485.00 15,485.00 611.00
			PLEASE NOTE: Weights and cubages shown on Page 205 are in error. Correct data is given below. Also listed are new models not in catalog and using dry type external transformers in place of heavier oil-filled units.	

CATALOG PAGE	FACTORY NUMBER	TYPE NUMBER	DESCRIPTION	UNIT PRICE	
205	M3786	HF-5B	Broadcast transmitter, 5KW, with oil-filled external transformers, for 60 cycles. Shipping wt.: 9800 lbs. cu: 535	21,900.00	
	M3786A M3786B	HF-5B HF-5B	Same as above but for 50 cycles Broadcast transmitter, 5KW, with dry type external transformers, for 60 cycles. Shipping wt.: 6500 lbs. Cubage: 485.	21,900.00	
	M3786C M3788	HF-5B HF-5BX	Same as M3786B but for 50 cycles Broadcast transmitter, 5KW, same as M3786, with keying added, and for 60 cycles.	21,100.00 21,100.00	
	M3788A M3788B	HF5-BX HF-5BX	Same as M3788 but for 50 cycles Broadcast transmitter, 5KW, same as M3788 but with dry type external transformers, keying, and for 60 cycles	22,300.00 22,300.00	
	M3788C M3790	HF-5BX HF-5C	Same as M3788B but for 50 cycles Communications transmitter, 5KW	21,500.00 21,500.00	
	M3790A M3792	HF-5C HF-5CX	Communications transmitter, 5KW Communications transmitter, 5KW	19,250.00 19,250.00	
	M3792A M3794	HF-5CX HF-5TX	Communications transmitter, 5KW Telegraph transmitter, 5KW	19,650.00 19,650.00	
	M3794A M3796	HF-5TX HFXT-1	Telegraph transmitter, 5KW Crystal and oven	15,485.00 15,485.00	
		TK252	HFTSB-5 tube set	34.60	
		TK254	HFTXB-5 tube set	1,070.25	
		TK256	HFK tube set	611.00 5.65	
	208	M4964	HF-1M	Broadcast transmitter, 1KW with tubes	5,875.00
			TK249	Tube kit	304.25
			H-7	Crystal and holder	14.95
			H-17	Crystal and holder	14.95
			JK-02	Crystal oven	12.50
			M5263 M5239		Limiter/filter amplifier Exciter only
210	M4575	CMG-1	Communications transmitter, 250 watts, with tubes	1,895.00	
		H-7	Crystal and holder	14.95	
		H-17	Crystal and holder	14.95	
		JK-02	Crystal oven	12.50	
		TK136	Tube kit	92.10	
		M4576		Microphone assembly Filters (all models)	39.50 60.00
212	M5593	CMP-1	Communications transmitter, with tubes	4,350.00	
	M5593A	CMP-1A	Communications transmitter, with tubes	4,350.00	
		CMP-1B	Communications transmitter, with tubes	4,350.00	
		CMP-1D	Communications transmitter, with tubes	4,350.00	
		CON-2	Remote control panel	4,695.00	
	CON-3	Remote control panel	116.50		
	TK138	Tube kit	(on application) 149.37		

CATALOG PAGE	FACTORY NUMBER	TYPE NUMBER	DESCRIPTION	UNIT PRICE	
213 (cont'd)	M3449Y	TK222	Two-channel transmitter with tubes	1,975.00	
			Tube kit	60.25	
			Coil sets (any range)	18.00	
			H-7 Crystal and holder	14.95	
			H-17 Crystal and holder	14.95	
			JK-02 Crystal oven	12.50	
	M4237		Microphone assembly	39.50	
214	M3491-Y	TK237	Single channel transmitter with tubes	1,705.00	
			Tube kit	45.05	
			Coil sets (any range)	18.00	
			H-7 Crystal and holder	14.95	
			H-17 Crystal and holder	14.95	
			JK-02 Crystal oven	12.50	
	M5237		Microphone assembly	39.50	
216	M4311-B	CMW-1	700-watt input communications transmitter	3,250.00	
	M4576-B		Microphone assembly	47.50	
		TK137	Tube kit	142.75	
		H-7 Crystal and holder	14.95		
		JK-02	Crystal oven	12.50	
217	M5569		CW transmitter	693.00	
	M5569		CW transmitter, less cabinet	670.50	
		TK291	Tube kit	23.10	
		H-17	Crystal and holder	14.95	
		JK-02	Crystal oven	12.50	
218	M5570		Modulator	467.00	
	M5570		Modulator, less cabinet	444.50	
		TK292	Tube kit	22.65	
			Microphone assembly	39.50	
	M4576	CM-65	Transmitter	1,160.00	
	M5588	CR-65	Transmitter	1,115.00	
			Microphone assembly	39.50	
			H-17	Crystal and holder	14.95
			JK-02	Crystal oven	12.50
	220	M5805	SSB-100	Transmitter/receiver	(on application)
M5882			Crystal	(on application)	
		TK353	Tube kit	(on application)	
222.	M5708		Oscillator buffer amplifier unit	(on application)	
	M5709		Oscillator buffer amplifier unit	(on application)	
	M5704		CW amplifier, 1KW	(on application)	
	M5705		CW amplifier, 1KW	(on application)	
	M5706		CW amplifier, 1KW	(on application)	
223	M5077		Transmitter	(on application)	
			Crystal oven	(on application)	
		JK-07E	Crystal for above oven	(on application)	
		H-18	Tube kit	(on application)	
		TK199	Transmitter	(on application)	
	M5076	JK-07E	Crystal oven, less crystal	(on application)	
		H-18	Crystal for above oven	(on application)	
		TK198	Tube kit	373.64	

CATALOG PAGE	FACTORY NUMBER	TYPE NUMBER	DESCRIPTION	UNIT PRICE	
224	M3975	H-17	Homing beacon transmitter	7,900.00	
	M4116		Antenna coupler	425.00	
	M4124		Remote control/audio amplifier	525.00	
			Microphone desk stand	32.50	
			Crystal	14.95	
225		MPS-1	UHF command transmitter	(on application)	
		MPS-73	Checkout generator	(on application)	
			VLF linear amplifier	(on application)	
226	M5610		VHF transmitter, 50 watts	1,995.00	
227	M3815	TK230 BFR-50C TK310	Totalizing recorder	1,375.00	
	M5507		Totalizing recorder	905.00	
	Tube kit		36.25		
	FM relay transmitter		1,875.00		
	Tube kit		69.40		
	Single Multiplex sub-channel		895.00		
	Dual Multiplex sub-channel		1,195.00		
228	M5645			VHF dummy antenna	22.50
				Water cooled dummy antenna (all models)	(on application)
	M5263			Communications amplifier	295.00
	M5263A		Communications amplifier	295.00	
		TK235	Tube kit	8.15	
	M3922		Selective amplifier (single quantities)	300.00	
	M3922		Selective amplifier (quantities 2 thru 9)	260.00	
	M5138		Tube kit	9.86	
229	M4230	117C903	Remote control system	280.00	
			VFO/crystal oscillator	950.00	
			Crystal and oven	60.00	
			Citizens Band transceiver	532.00	
			Citizens Band transceiver, with remote control	562.00	
			Citizens Band transceiver, for 12 volt DC or 117 volt AC	554.00	
			Set of 3 crystals	38.00	
			Roof top antenna	9.80	
			Dynamic microphone	4.00	
			50Kc IF filter (optional)	13.80	
230	M5644	A-4002	Whip antenna	(on application)	
		770	Oscilloscope	470.00	
		685	Oscilloscope, portable	(on application)	
		6000	Tube tester	197.50	
		539B	Tube tester, industrial	439.00	
		BL-1	Blank panels, per 1 3/4" multiples	1.50	
		335B	FM monitor	1,695.00	
			Desk rack cabinet	22.50	
			XLR3-11	Cannon connector	1.03
			XLR3-12	Cannon connector	.99
			XLR3-13	Cannon connector	1.03
			XLR3-14	Cannon connector	.79
			XLR3-35-2G	Cannon connector	6.17
			XL3-35	Cannon connector	2.90
			P3-14	Cannon connector	2.19

CATALOG PAGE	FACTORY NUMBER	TYPE NUMBER	DESCRIPTION	UNIT PRICE		
230 (cont'd)		P3-13	Cannon connector	3.68		
		P3-35	Cannon connector	5.74		
		P3-CG-11S	Cannon connector	4.16		
		P3-CG-12S	Cannon connector	3.40		
		P3-35-2G	Cannon connector	12.24		
		260	Volt-Ohm-Meter	43.95		
		0073	RF probe	7.50		
		311	Vacuum tube Volt-Ohm-Meter	64.95		
		TR-325	Industrial mobile phone	360.00		
		TR-426	Industrial mobile phone	360.00		
		TR-426A	Industrial mobile phone	360.00		
		231	M5666 M3737		Auditorium system	995.00
					Tubeless modulation monitor	95.00
				5907	Transistorized loudhailer	125.00
			M3934	GR-120	Battery kit	1.20
6U-RSF	Inverter			49.90		
6S-HSJ	Inverter			83.34		
12U-RSF	Inverter			49.90		
12U-HSJ	Inverter			83.34		
	Tube socket			45.00		
B-40216	Tube socket			150.00		
A-30687-1	Blower			130.00		
PJ-106	Audio terminal block			9.45		
114-321	Telegraph key			8.80		
GF-9	Touch-up paint			3.50		
GF-8	Touch-up paint			3.50		
GF-2	Touch-up paint	3.50				
GF-3	Touch-up paint	3.50				
232		GPR-90RX	SSB crystal control receiver	640.00		
		GSB-1	TMC SSN adaptor	149.50		
		CM-O	FM relay receiver	75.00		
		117R905	Conelrad receiver	140.00		
		117R906	Conelrad receiver	140.00		
		TRC-1	TV rebroadcast receiver	1,150.00		
			Extra tuners	150.00		

## GENERAL SALES POLICY AND TERMS

### PRICES

Gates maintains a standard price policy. All prices are F. O. B. Quincy, or F. O. B. point of origin for non-Gates manufactured items. Prices do not include any Federal, State or Local Tax. All published prices are subject to change without notice.

### WARRANTY

Gates warranty provides excellent product protection. A copy of our comprehensive warranty will be furnished on request. Products, not manufactured by Gates, bear only the maker's warranty. Equipment installation, maintenance and operation are the responsibility of the purchaser. In no event shall Gates be liable for anticipated profits or for consequential damages.

### MODIFICATION

Gates reserves the right to modify any product without notice in the interest of improved performance or design. Gates also reserves the right to withdraw any product from sale without notice.

### SHIPMENT

Gates proudly offers fast shipment service. In absence of specific shipping instructions, the method of shipment and the carrier shall be selected by Gates. Gates shall not be liable for any delays in or inability to complete the manufacture and shipment of equipment. Delays shall not relieve the purchaser of his obligation of performance. Items damaged in transit should be called to the attention of the delivering carrier immediately and claims placed within five days. Purchaser must provide satisfactory insurance when special transportation utilized.

### PAYMENT ARRANGEMENTS

Gates recommends establishment of a standard credit account. Where credit is not established, to expedite service, shipments will be made on a C.O.D. basis. Gates offers an excellent time payment plan for larger purchases. The customer must confirm by purchase order, letter or wire, all verbal orders. All terms of payment are subject to final acceptance by Gates Radio Company, Quincy, Illinois.

### REPAIRS AND RETURNS

If necessary to return any item for repair or adjustment, customers should receive Gates standard return authorization form which is available from Gates Home Office—Quincy, Illinois. Gates can not accept liability for unauthorized returns.

### ACCEPTANCE

All orders are subject to final written acceptance at Gates Home Office—Quincy, Illinois. The banking of, or other use of the down payment, shall not constitute acceptance of any order by seller.

### OUR OBJECTIVE

Our objective is to provide the best possible equipment and the finest possible service to a wonderful industry that we have been privileged to serve for nearly 40 years.

## GATES RADIO COMPANY

Subsidiary of Harris-Intertype Corporation

Quincy, Illinois, U. S. A.