

IEEE JAPAN DIRECTORY 1967-1968

Although all information has been obtained from current questionnaires, IEEE cannot accept responsibility for accuracy. Bold-faced listings indicate products manufactured for export. SERVICES section begins on page 60 and ALPHABETICAL INDEX on page 61. The latter lists complete sales-office addresses in Japan, U.S.A., and Europe for all firms listed in the product sections. Use Reader Service Coupon on page 60 to request more information, or contact firms directly mentioning the IEEE JAPAN DIRECTORY. Firms not included failed to submit questionnaires.

Aerospace Equipment (Communications, Navigation, Test)

Japan Vacuum Engineering Co., Ltd.
Kobe Industries Corp.
Nippon Electric Co., Ltd., 7-15 Shiba
Gochome, Minato-ku, Tokyo (Cable:
Microphone); 200 Park Ave., New
York, N.Y. 10017 (Tel: MO 1-3420);
80 rue de Namur, Bruxelles 1, Belgique
(Tel: 12-74-61)
Showa Musen Kogyo Co., Ltd., 6-5-5
Togoshi, Shinagawa-ku, Tokyo (Cable:
Showamusen)

Amplifiers

DX Antenna Co., Ltd.
Foster Electric Co., Ltd., 512 Miyazawa-
machi, Akishima-city, Tokyo (Cable:
Foster Akishima); 230 N. Michigan
Ave., Chicago, Ill.
Fujitsu Limited
Ikegami Tsushinki Co., Ltd.
Kobe Industries Corp.
Nippon Electric Co., Ltd., 7-15 Shiba
Gochome, Minato-ku, Tokyo (Cable:
Microphone); 200 Park Ave., New
York, N.Y. 10017 (Tel: MO 1-3420);
80 rue de Namur, Bruxelles 1, Belgique
(Tel: 12-74-61)
Nippon Trumpet Trading Co., Ltd.
(AC/DC)
Pioneer Electronic Corp., 15-5 Nishi 4-
chome Ohmori, Ohta-ku, Tokyo (Cable:
Pioneer); 140 Smith St., Farmingdale,
N.Y. 11735 (Tel: 516-694-7720); 59
Forch Strasse, 8032 Zurich, Switzer-
land (Tel: 477565)
Sansui Electric Co., Ltd., 460 Izumi-cho,
Suginami-ku, Tokyo (Cable: San-
suiElec)
Sony Corp., 351 Kitashinagawa-6, Shina-
gawa-ku, Tokyo (Cable: Sonycorp)
Toa Electric Co., Ltd.
Tokyo Cosmos Electric Co., Ltd.
Tokyo Shibaura Electric Co., Ltd.
(Toshiba), 1-1 Uchisaiwaicho, Chiyoda-
ku, Tokyo (Cable: Toshiba); 530 Fifth
Ave., New York, N.Y. 10036 (Tel:
587-5471); Berliner Allee 26, Duessel-
dorf 1, Germany (Tel: 29648-9)
Yokogawa Electric Works, Ltd.

Antennas and Accessories

DX Antenna Co., Ltd.
Fujitsu Limited

Furukawa Electric Co., Ltd.
Kobe Industries Corp.
Nippon Electric Co., Ltd., 7-15 Shiba
Gochome, Minato-ku, Tokyo (Cable:
Microphone); 200 Park Ave., New
York, N.Y. 10017 (Tel: MO 1-3420); 80
rue de Namur, Bruxelles 1, Belgique
(Tel: 12-74-61)
Tokyo Shibaura Electric Co., Ltd.
(Toshiba), 1-1 Uchisaiwaicho, Chiyoda-
ku, Tokyo (Cable: Toshiba); 530
Fifth Ave., New York, N.Y. 10036
(Tel: 587-5471); Berliner Allee 26,
Duesseldorf 1, Germany (Tel: 29648-9)
Yokowo Mfg. Co., Ltd.

Attenuators

Anritsu Electric Co., Ltd., 4-12-20 Min-
ami-Azabu, Minato-ku, Tokyo (Cable:
Anritdenki)
DX Antenna Co., Ltd.
Hitachi Ltd.
Nippon Electric Co., Ltd., 7-15 Shiba
Gochome, Minato-ku, Tokyo (Cable:
Microphone); 200 Park Ave., New
York, N.Y. 10017 (Tel: MO 1-3420);
80 rue de Namur, Bruxelles 1, Belgique
(Tel: 12-74-61)
TDS Electronics Co., Ltd., Apond Bldg.,
1-7-12 Soto-Kanda, Chiyoda-ku, Tokyo
(Cable: Tdselectronics)
Takeda Riken Industry Co., Ltd., 285
Asahi-cho, Nerima-ku, Tokyo (Cable:
Tritronics)

Audio Equipment

Chiyoda Electronic Co., Ltd.
Foster Electric Co., Ltd., 512 Miyazawa-
machi, Akishima-city, Tokyo (Cable:
Foster Akishima); 230 N. Michigan
Ave., Chicago, Ill.
Fujitsu Limited
Hayakawa Electric Co., Ltd., Abeno-ku,
Osaka (Cable: Labomet Osaka); Sharp
Electronics Corp., 178 Commerce Rd.,
Carlstadt, N.J. (Tel: 201-933-4200);
Hohe Bleichen 16, 2 Hamburg 36,
Germany
Nippon Electric Co., Ltd., 7-15 Shiba
Gochome, Minato-ku, Tokyo (Cable:
Microphone); 200 Park Ave., New
York, N.Y. 10017 (Tel: MO 1-3420);
80 rue de Namur, Bruxelles 1, Bel-
gique (Tel: 12-74-61)
Oki Electric Industry Co., Ltd.
Osaka Onkyo Co., Ltd., 5-32 Ohmiya
Nishinocho, Asahi-ku, Osaka (Cable:

Onkyo Osaka); JEG, Stegstrasse 34,
6000 Frankfurt/M., Germany (Tel:
61-35-95)

Pioneer Electronic Corp., 15-5 Nishi 4-
chome Ohmori, Ohta-ku, Tokyo (Cable:
Pioneer); 140 Smith St., Farmingdale,
N.Y. 11735 (Tel: 516-694-7720); 59
Forch Strasse, 8032 Zurich, Switzer-
land (Tel: 477565)
Sansui Electric Co., Ltd., 460 Izumi-cho,
Suginami-ku, Tokyo (Cable: Sansui-
elec)
Sony Corp., 351 Kitashinagawa-6, Shina-
gawa-ku, Tokyo (Cable: Sonycorp)
Telecon Corp.
Tokai Communication Apparatus Corp.
Tokyo Cosmos Electric Co., Ltd.
Tokyo Shibaura Electric Co., Ltd.
(Toshiba), 1-1 Uchisaiwaicho, Chiyoda-
ku, Tokyo (Cable: Toshiba); 530 Fifth
Ave., New York, N.Y. 10036 (Tel:
587-5471); Berliner Allee 26, Duessel-
dorf 1, Germany (Tel: 29648-9)

Automatic Control Equipment

Fujitsu Limited, Furukawa Sogo Bldg.,
2-8 Marunouchi, Chiyoda-ku, Tokyo
(Cable: Fujitsulimited); 680 Fifth Ave.,
New York, N.Y. 10019 (Tel: CO
5-5360)
Hokuyo Electric Industrial Co., Ltd.
Izumi Denki Co., Ltd.
Kobe Industries Corp.
Nippon Electric Co., Ltd., 7-15 Shiba
Gochome, Minato-ku, Tokyo (Cable:
Microphone); 200 Park Ave., New
York, N.Y. 10017 (Tel: MO 1-3420);
80 rue de Namur, Bruxelles 1, Belgique
Tel: 12-74-61)
Ohkura Electric Co., Ltd.
Oki Electric Industry Co., Ltd.
Ono Measuring Instrument Co., Ltd.
Shibaura Electronics Co., Ltd.
Takeda Riken Industry Co., Ltd., 285
Asahi-cho, Nerima-ku, Tokyo (Cable:
Tritronics)
Tateisi Electronics Co., Ltd.
Tokyo Seimitsu Co., Ltd.
Yokogawa Electric Works, Ltd.

Batteries and Energy Conversion Devices

Fuji Electrochemical Co., Ltd., Hamagomu
Bldg., 5-11-36 Shimbashi, Minato-ku,
Tokyo (Cable: Noveldrycell); 437 Fifth
Ave., New York, N.Y. 10016 (Tel:

LE 2-5630); Neuerwall 34, Hamburg 36, Germany

Tokyo Shibaura Electric Co., Ltd. (Toshiba), 1-1 Uchisaiwaicho, Chiyoda-ku, Tokyo (Cable: Toshiba); 530 Fifth Ave., New York, N.Y. 10036 (Tel: 587-5471); Berliner Allee 26, Duesseldorf 1, Germany (Tel: 29648-9)

Bio-Medical Equipment

Hayakawa Electric Co., Ltd., Abeno-ku, Osaka (Cable: Labomet Osaka); Sharp Electronics Corp., 178 Commerce Rd., Carlstadt, N.J. (Tel: 201-933-4200); Hohe Bleichen 16, 2 Hamburg 36, Germany

Horiba Instruments, Inc.

Japan Vacuum Engineering Co., Ltd.

Nippon Electric Co., Ltd., 7-15 Shiba Gochome, Minato-ku, Tokyo (Cable: Microphone); 200 Park Ave., New York, N.Y. 10017 (Tel: MO 1-3420); 80 rue de Namur, Bruxelles 1, Belgique (Tel: 12-74-61)

Osaka Onkyo Co., Ltd.

Shibaura Electronics Co., Ltd.

Taiyo Electronics Corp., 6-5-1 Togoshi, Shinagawa-ku, Tokyo (Cable: Apolohagita)

Tateisi Electronics Co., Ltd.

Toa Electric Co., Ltd.

Tokyo Shibaura Electric Co., Ltd. (Toshiba), 1-1 Uchisaiwaicho, Chiyoda-ku, Tokyo (Cable: Toshiba); 530 Fifth Ave., New York, N.Y. 10036 (Tel: 587-5471); Berliner Allee 26, Duesseldorf 1, Germany (Tel: 29648-9)

Yanagimoto Mfg. Co., Ltd.

Yokogawa Electric Works, Ltd.

Blowers and Fans

Nippon Blower Co., Ltd.

Bridges and Decades

Meguro Denpa Sokki K. K.

Nippon Electric Co., Ltd., 7-15 Shiba Gochome, Minato-ku, Tokyo (Cable: Microphone); 200 Park Ave., New York, N.Y. 10017 (Tel: MO 1-3420); 80 rue de Namur, Bruxelles 1, Belgique (Tel: 12-74-61)

Tokyo Shibaura Electric Co., Ltd. (Toshiba), 1-1 Uchisaiwaicho, Chiyoda-ku, Tokyo (Cable: Toshiba); 530 Fifth Ave., New York, N.Y. 10036 (Tel: 587-5471); Berliner Allee 26, Duesseldorf 1, Germany (Tel: 29648-9)

Yokogawa Electric Works, Ltd.

Cabinets and Enclosures

Izumi Denki Co., Ltd.

Pioneer Electronic Corp., 15-5 Nishi 4-chome Ohmori, Ohta-ku, Tokyo (Cable: Pioneer); 140 Smith St., Farmingdale, N.Y. 11735 (Tel: 516-694-7720); 59 Forch Strasse, 8032 Zurich, Switzerland (Tel: 477565)

Settsu Metal Industrial Co., Ltd.

Cable and Wire

DX Antenna Co., Ltd.

Furukawa Electric Co., Ltd.

Hitachi, Ltd.

Tohoku Metal Industries, Ltd., 7-4 Ginza-Higashi, Chuo-ku, Tokyo (Cable: Tohokumetal)

Cameras and Photographic Devices

Canon Camera Co., Inc.

Ikegami Tsushinki Co., Ltd., 20 Motoki, Kawasaki-city (Cable: Iketsu Kawasaki); Ikegami Electronics Industries, Inc., 501 Fifth Ave., New York, N.Y. 10017 (Tel: 867-9209)

Nippon Electric Co., Ltd., 7-15 Shiba Gochome, Minato-ku, Tokyo (Cable: Microphone); 200 Park Ave., New York, N.Y. 10017 (Tel: MO 1-3420); 80 rue de Namur, Bruxelles 1, Belgique (Tel: 12-74-61)

Capacitors, Fixed

Fox Electronics Co., Ltd., 5-32-8 Kamata, Ohta-ku, Tokyo (Cable: Foxdenshi); JEG, Stegstrasse 34, 6000 Frankfurt, Germany (Tel: 61-35-95)

Fujitsu Limited, Furukawa Sogo Bldg., 2-8 Marunouchi, Chiyoda-ku, Tokyo (Cable: Fujitsulimited); 680 Fifth Ave., New York, N.Y. 10019 (Tel: CO 5-5360)

FOX offers you the finest products

Printed Circuit Boards, UL approved, and Electrolytic Capacitors..... high quality, high stability, long life and reasonable price.

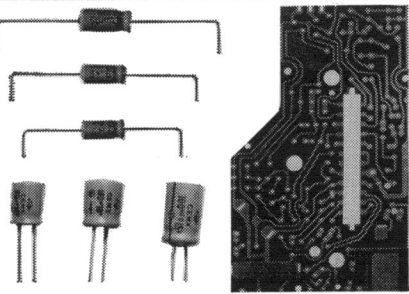

Main Products:

- Electrolytic Capacitors
- Solid Electrolytic Tantalum & Aluminum Capacitors
- Printed Circuit Boards



For full details, please write to:
FOX ELECTRONICS CO., LTD.
Export Dept., 32-8, kamata 5-chome Ohta-ku, Tokyo, Japan

MATSUO

Highly Reliable Capacitors

POLYESTER FILM CAPACITORS.



Type MXT



Type MFK

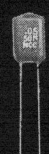

Type MFL

Type MXT In plastic tube. Capacitance Range: .001 MFD to .22 MFD. Voltages: 100v, 200v, 400v, 600v DC.

Type MFK Dipped flat shape, non-inductive construction. capacitance Range: .01 MFD to .47 MFD. Voltages: 100v, 200v, 400v, 600v DC.

Type MFL Dipped flat shape. Capacitance Range: .001 MFD to .22 MFD. Voltages: 50v, 100v, 200v DC.

METALLIZED POLYESTER FILM CAPACITORS.



Type FNX-H

Type FNX-H Mylar wrapped semioval with epoxy end seal. Capacitance Range: 1 MFD to 10 MFD. Voltages: 100v, 200v, 400v, 600v DC.

SOLID TANTALUM CAPACITORS.



Type TAX



Type TSX



Type TSL

Type TAX MIL-C-26655A hermetically sealed.

Type TSX · TSL Sealed with epoxy resin. Capacitance Range: .22MFD to 330 MFD. Voltages: 3v, 6v, 10v, 15v, 20v, 25v, 35v, 50v DC.

for full details, contact :

MATSUO ELECTRIC CO., LTD.

3-chome, Sennari-cho, Toyonaka-shi, Osaka, Japan
Cable Address "NCC MATSUO" OSAKA

TAIYO's RESISTORS & CAPACITORS

FIXED COMPOSITION RESISTORS

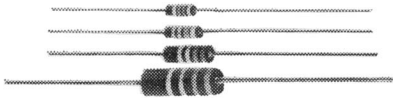

CERAMIC DISK CAPACITORS



ELECTROLYTIC CAPACITORS

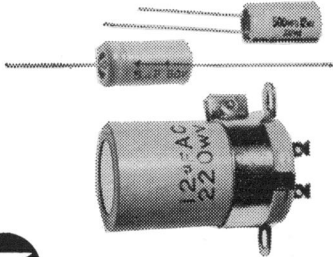

Further information write to:

TAIYO DENKI CO., LTD.

1-12, 3-chome, Sunamichi, Sakai City,
Osaka, Japan.

Cable address: SOLIDTAIYOHM SAKAI
Telephone: SAKAI (3) 6841

KCK Co., Ltd.

Matsuo Electric Co., Ltd., 3-chome
Sennari-cho, Toyonaka-city, Osaka
(Cable: Ncmatsuo Osaka)

Matsushita Electric Industrial Co., Ltd.,
Electronic Components Div., Osaka;
Matsushita Electric Corp. of America,
200 Park Ave., New York, N.Y. 10017
(Tel: 973-5710); Jungfernstieg 40,
2 Hamburg 36, Germany (Tel: 344743)

Murata Mfg. Co., Ltd.

Nichicon Capacitor, Ltd.

Nippon Chemical Condenser Co., Ltd.

Nippon Electric Co., Ltd., 7-15 Shiba
Gochome, Minato-ku, Tokyo (Cable:
Microphone); 200 Park Ave., New
York, N.Y. 10017 (Tel: MO 1-3420);
80 rue de Namur, Bruxelles 1, Bel-
gique (Tel: 12-74-61)

Nissei Electric Co., Ltd.

Nitsuko Ltd., 260 Kitamikata, Kawasaki-
city (Cable: Kawasaki Nicomm)

Oki Electric Industry Co., Ltd.

Omori Denki Seisakusho Co., Ltd.

Shinyei Co., Ltd.

Soshin Electric Co, Ltd., 1-18-18 Naka-
magome, Ohta-ku, Tokyo (Cable: So-
shin Capacitor)

TDK Electronics Co., Ltd., 2-14-6
Uchi-Kanda, Chiyoda-ku, Tokyo (Cable:
Tdkcore); 81 Wall St., New York, N.Y.
10005 (Tel: 425-7070); 6151 W. Cen-
tury Blvd., Los Angeles, Calif. 90045
(Tel: OR 0-5515)

Taiyo Denki Co., Ltd., 3-1-12 Sunamichi-
cho, Sakai-city, Osaka (Cable: Solid-
taiyohm Osaka)

Teikoku Tsushin Kogyo Co., Ltd.

Tokyo Denki Co., Ltd.

Towa Chikudenki Co., Ltd.

Capacitors, Variable

Alps Electric Co., Ltd., 247 Yukigaya-cho,
Ohta-ku, Tokyo (Cable: Alpsden-
ki); 1 Whitehall St., New York, N.Y.
10004

Fujitsu Limited, Furukawa Sogo Bldg.,
2-8 Marunouchi, Chiyoda-ku, Tokyo
(Cable: Fujitsulimited); 680 Fifth Ave.,
New York, N.Y. 10019 (Tel: CO 5-
5360)

KCK Co., Ltd.

Matsushita Electric Industrial Co., Ltd.,
Electronic Components Div., Osaka;
Matsushita Electric Corp. of America,
200 Park Ave., New York, N.Y. 10017
(Tel: 973-5710); Jungfernstieg 40, 2
Hamburg 36, Germany (Tel: 344743)

Mitsumi Electric Co., Ltd., 1056 Koadachi,
Koma-cho, Kitatama-gun, Tokyo
(Cable: Mparts Tokyochofu); 11 Broad-
way, New York, N.Y. 10004 (Tel: HA
5-3085); Marienstrasse 12, Duessel-
dorf, Germany

Murata Mfg. Co., Ltd.

Nippon Electric Co., Ltd., 7-15 Shiba
Gochome, Minato-ku, Tokyo (Cable:
Microphone); 200 Park Ave., New
York, N.Y. 10017 (Tel: MO 1-3420);
80 rue de Namur, Bruxelles 1, Belgique
(Tel: 12-74-61)

San Esu Electronics Co., Ltd.

Sansei Electric Co., Ltd.

TDK Electronics Co., Ltd., 2-14-6 Uchi-
Kanda, Chiyoda-ku, Tokyo (Cable:
Tdkcore); 82 Wall St., New York, N.Y.
10005 (Tel: 425-7070)

Toyo Communication Equipment Co.,
Ltd.

Ceramics

Fujitsu Limited

Kyoto Ceramic Co., Ltd., 11 Hara-machi,
Nishino-kyo, Nakagyo-ku, Kyoto
(Cable: Kyocera Kyoto) (Including
hermetic seals and transistor beads)

Matsushita Electric Industrial Co., Ltd.,
Electronic Components Div., Osaka;
Matsushita Electric Corp. of America,
200 Park Ave., New York, N.Y. 10017
(Tel: 973-5710); Jungfernstieg 40, 2
Hamburg 36, Germany (Tel: 344743)

Murata Mfg. Co., Ltd.

NGK Spark Plug Co., Ltd., Mizuho-ku,
Nagoya (Cable: Plugngk Nagoya);
4010 Sawtelle Blvd., Los Angeles,
Calif. 90066 (Tel: 213-397-8184)

Nihon Steatite Industry Co., Ltd.

Nippon Electric Co., Ltd., 7-15 Shiba
Gochome, Minato-ku, Tokyo (Cable:
Microphone); 200 Park Ave., New
York, N.Y. 10017 (Tel: MO 1-3420);
80 rue de Namur, Bruxelles 1, Belgique
(Tel: 12-74-61)

"ARIGATO"
有難う!

in actual size

"Arigato" is Thank You in Japanese. And this is what Soshin would like to convey to the many American users — 27 top manufacturers — of its Mica Capacitors. They have immensely helped Soshin in becoming a proud producer of more than 22,000,000 pcs. a month. Soshin is also proud of having supplied its products without a single complaint against either quality or delivery.

Monthly output of Soshin's "trio"
in mica capacitors:

- Dipped Mica Capacitors.... 2,000,000 pcs.
- V-FMCON..... 8,000,000 pcs.
- FMCON..... 12,000,000 pcs.

The only mica capacitor maker in Japan with
MIL-C-5C qualifications.

For further information, write to
**SOSHIN SOSHIN
ELECTRIC CO., LTD.**
18-18, Nakamagome 1-chome, Ohta-ku, Tokyo, Japan
Cables: SOSHINCAPACITOR TOKYO

CAPACITORS

(Catalog No. E-302)

(Catalog No. E-303)

All-welded construction Miniature
Aluminum Electrolytic Capacitors

eam File System | Sec.
electronic engineers master | 1500

Announcement:
NEW NAME effective August 1st, 1967!

Sole Sales Rep.: (USA & Canada Area)
MH & W International Corporation
280 Midland Avenue, Saddle Brook,
New Jersey 07662, U.S.A.
TEL: 201-7916277, 201-7916278

Nitsuko Ltd.

(Formerly NIPPON COMMUNICATION INDUSTRIAL CO., LTD.)
260 Kitamikata, Kawasaki, Japan
(Cable: KAWASAKI NITSUKO) TELEX: 3842-177 NITSUKO KAW

Chemicals and Compounds

Fujitsu Limited
Murata Mfg. Co., Ltd.
Risho Kogyo Co., Ltd.
Tamura Seisakusho Co., Ltd. (Tamradio Co., Ltd.)
Tokyo Shibaura Electric Co., Ltd. (Toshiba), 1-1 Uchisaiwaicho, Chiyoda-ku, Tokyo (Cable: Toshiba); 530 Fifth Ave., New York, N.Y. 10036 (Tel: 587-5471); Berliner Allee 26, Duesseldorf 1, Germany (Tel: 29648-9)

Circuits and Modules

Fox Electronics Co., Ltd., 5-32-8 Kamata, Ohta-ku, Tokyo (Cable: Foxdenshi); JEG, Stegstrasse 34, 6000 Frankfurt, Germany (Tel: 61-35-95)
Fujitsu Limited
Kobe Industries Corp.
Matsushita Electric Industrial Co., Ltd., Electronic Components Div., Osaka; Matsushita Electric Corp. of America, 200 Park Ave., New York, N.Y. 10017 (Tel: 973-5710); Jungfernstieg 40, 2 Hamburg 36, Germany (Tel: 344743)
Murata Mfg. Co., Ltd.
Nippon Electric Co., Ltd., 7-15 Shiba Gochome, Minato-ku, Tokyo (Cable: Microphone); 200 Park Ave., New York, N.Y. 10017 (Tel: MO 1-3420); 80 rue de Namur, Bruxelles 1, Belgique (Tel: 12-74-61)
Sanwa Print Seisakusho Co., Ltd.
Shin-ei Industrial Co., Ltd.
TDK Electronics Co., Ltd., 2-14-6 Uchi-Kanda, Chiyoda-ku, Tokyo (Cable: Tdkcore); 82 Wall St., New York, N.Y. 10005 (Tel: 425-7070)
Tokyo Print Industrial Co., Ltd., 782 Shimoishihara, Chofu-city, Tokyo (Tel: 0424-83-5711)
Toyo Communication Equipment Co., Ltd.

Circuits, IC

Fujitsu Limited
Kyodo Electronic Laboratories, Inc., 5153 Kamitsuruma, Sagamihara-City (Cable: Kelic Machida)
Matsushita Electric Industrial Co., Ltd., Electronic Components Div., Osaka; Matsushita Electric Corp. of America, 200 Park Ave., New York, N.Y. 10017 (Tel: 973-5710); Jungfernstieg 40, 2 Hamburg 36, Germany (Tel: 344743)
Nippon Electric Co., Ltd., 7-15 Shiba Gochome, Minato-ku, Tokyo (Cable: Microphone); 200 Park Ave., New York, N.Y. 10017 (Tel: MO 1-3420); 80 rue de Namur, Bruxelles 1, Belgique (Tel: 12-74-61)
Oki Electric Industry Co., Ltd.
Tokyo Denki Co., Ltd.
Tokyo Shibaura Electric Co., Ltd. (Toshiba), 1-1 Uchisaiwaicho, Chiyoda-ku, Tokyo (Cable: Toshiba); 530 Fifth Ave., New York, N.Y. 10036 (Tel: 587-5471); Berliner Allee 26, Duesseldorf 1, Germany (Tel: 29648-9)

Coils and Coil Winders

Fujitsu Limited
Hokuyo Musen Kogyo Co., Ltd.
Mitsumi Electric Co., Ltd., 1054 Koadachi, Komae-cho, Kitatama-gun, Tokyo (Cable: Mparts Tokyochofu); 11 Broadway, New York, N.Y. 10004 (Tel: HA 5-3085); Marienstrasse 12, Duesseldorf, Germany
Nippon Electric Co., Ltd., 7-15 Shiba Gochome, Minato-ku, Tokyo (Cable: Microphone); 200 Park Ave., New York, N.Y. 10017 (Tel: MO 1-3420); 80 rue de Namur, Bruxelles 1, Belgique (Tel: 12-74-61)
TDK Electronics Co., Ltd., 2-14-6 Uchi-Kanda, Chiyoda-ku, Tokyo (Cable: Tdkcore); 82 Wall St., New York, N.Y. 10005 (Tel: 425-7070) (Choke coils)
Teikoku Tsushin Kogyo Co., Ltd.
Tohoku Metal Industries, Ltd., 7-4 Ginza-Higashi, Chuo-ku, Tokyo (Cable: Tohokumetal)
Toko, Inc.
Toyo Conepaper Co., Ltd.

Communications Receivers and Transmitters

Anritsu Electric Co., Ltd., 4-12-20 Minami-azabu, Minato-ku, Tokyo (Cable: Anritdenki)
Fujitsu Limited, Furukawa Sogo Bldg., 2-8 Marunouchi, Chiyoda-ku, Tokyo (Cable: Fujitsulimited); 680 Fifth Ave., New York, N.Y. 10019 (Tel: CO 5-5360)
Ikegami Tsushinki Co., Ltd., 21 Motoki, Kawasaki-city (Cable: Iketsu Kawasaki); Ikegami Electronics Industries, Inc., 501 Fifth Ave., New York, N.Y. 10017 (Tel: 867-9209)
Iwasaki Communication Apparatus Co., Ltd., 2-710 Kugayama, Sugiyama-ku, Tokyo (Cable: Telephiwasaki)
Kobe Industries Corp.
Nippon Electric Co., Ltd., 7-15 Shiba Gochome, Minato-ku, Tokyo (Cable: Microphone); 200 Park Ave., New York, N.Y. 10017 (Tel: MO 1-3420); 80 rue de Namur, Bruxelles 1, Belgique (Tel: 12-74-61)
Nissin Electronics Co., Ltd.
Oki Electric Industry Co., Ltd.

Tamura Seisakusho Co., Ltd. (Tamradio Co., Ltd.)
Tokai Communication Apparatus Corp.
Tokyo Shibaura Electric Co., Ltd. (Toshiba), 1-1 Uchisaiwaicho, Chiyoda-ku, Tokyo (Cable: Toshiba); 530 Fifth Ave., New York, N.Y. 10036 (Tel: 587-5471); Berliner Allee 26, Duesseldorf 1, Germany (Tel: 29648-9)
Toyo Communication Equipment Co., Ltd.

Computer Accessories

Fujitsu Limited, Furukawa Sogo Bldg., 2-8 Marunouchi, Chiyoda-ku, Tokyo (Cable: Fujitsulimited); 680 Fifth Ave., New York, N.Y. 10019 (Tel: CO 5-5360)
Hayakawa Electric Co., Ltd., Abeno-ku, Osaka (Cable: Labomet); Sharp Electronics Corp., 178 Commerce Rd., Carlstadt, N.J. (Tel: 201-933-4200); Hohe Bleichen 16, 2 Hamburg 36, Germany
Iwasaki Communication Apparatus Co., Ltd., 2-710 Kugayama, Sugiyama-ku, Tokyo (Cable: Telephiwasaki)
Nippon Electric Co., Ltd., 7-15 Shiba Gochome, Minato-ku, Tokyo (Cable: Microphone); 200 Park Ave., New York, N.Y. 10017 (Tel: MO 1-3420); 80 rue de Namur, Bruxelles 1, Belgique (Tel: 12-74-61)
Tateisi Electronics Co., Ltd.
Tokyo Shibaura Electric Co., Ltd. (Toshiba), 1-1 Uchisaiwaicho, Chiyoda-ku, Tokyo (Cable: Toshiba); 530 Fifth Ave., New York, N.Y. 10036 (Tel: 587-5471); Berliner Allee 26, Duesseldorf 1, Germany (Tel: 29648-9)

Computer Memories and Subsystems

Fuji Electrochemical Co., Ltd., Hamagomu Bldg., 5-11-36 Shimbashi, Minato-ku, Tokyo (Cable: Noveldrycell); 537 Fifth Ave., New York, N.Y. 10016 (Tel: LE 2-5630); Neuerwall 34, Hamburg 36, Germany
Fujitsu Limited, Furukawa Sogo Bldg., 2-8 Marunouchi, Chiyoda-ku, Tokyo (Cable: Fujitsulimited); 680 Fifth Ave., New York, N.Y. 10019 (Tel: CO 5-5360)

11 experts at work on every printed board

(UL Approved: E-38255)

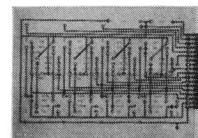
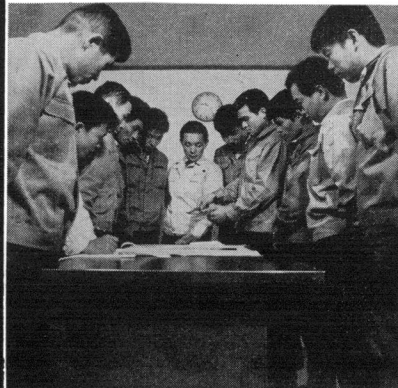

For computer use

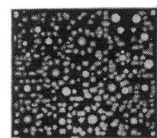

For TV use



● Top in performance & Service.

TOKYO PRINT INDUSTRIAL CO., LTD.
No. 782, Shimoishihara, Chofu-shi, Tokyo, Japan
Tel. 0424 (83) 5711

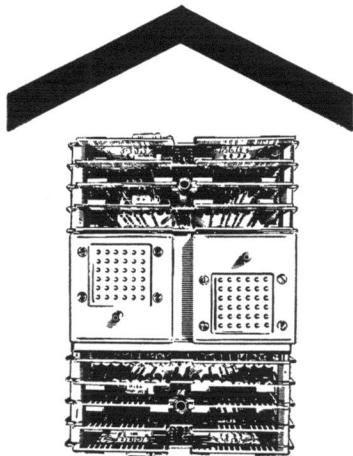

**all under
one roof:**

Tokin memory systems are totally Tokin from start to finish. At Tokin we handle everything concerned with the memory systems we make. That's why we guarantee top quality: the Tokin quality you expect. We not only save time by doing it all ourselves, we save you money by cutting costs.

Tokin is the largest manufacturer of memory cores, planes and stacks in Japan. (We make more 20-mil-and-under cores than anyone else here.) Tokin uses its famous ferrite cores for the very latest in 2½D memory systems: you get improved performance, lower cost potential in larger memory sizes.

Write:

Tokin

Tohoku Metal Industries, Ltd.
4, 7-chome, Ginza-Higashi, Chuo-ku, Tokyo, Japan
Telephone: Tokyo 542-6171
Cable Address: TOHOKUMETAL TOKYO

Nippon Electric Co., Ltd., 7-15 Shiba Gochome, Minato-ku, Tokyo (Cable: Microphone); 200 Park Ave., New York, N.Y. 10017 (Tel: MO 1-3420); 80 rue de Namur, Bruxelles 1, Belgique (Tel: 12-74-61)

TDK Electronics Co., Ltd., 2-14-6 Uchi-Kanda, Chiyoda-ku, Tokyo (Cable: Tdkcore); 82 Wall St., New York, N.Y. 10005 (Tel: 425-7070)

Tateisi Electronics Co., Ltd.

Tohoku Metal Industries, Ltd., 7-4 Ginza-Higashi, Chuo-ku, Tokyo (Cable: Tohokumetal)

Toko, Inc.

Toyo Communication Equipment Co., Ltd.

Computers and Calculators

Canon Camera Co., Inc. (calculators)

Casio Computer Co., Ltd. (calculators)

Fujitsu Limited, Furukawa Sogo Bldg., 2-8 Marunouchi, Chiyoda-ku, Tokyo (Cable: Fujitsulimited); 680 Fifth Ave., New York, N.Y. 10019 (Tel: CO 5-5360)

Hayakawa Electric Co., Ltd., Abeno-ku, Osaka (Cable: Labomet); Sharp Electronics Corp., 178 Commerce Rd., Carlstadt, N.J. (Tel: 291-933-4200); Hohe Bleichen 16, 2 Hamburg 36, Germany

Midori Precisions Co., Ltd. (calculators)

Nippon Electric Co., Ltd., 7-15 Shiba Gochome, Minato-ku, Tokyo (Cable: Microphone); 200 Park Ave., New York, N.Y. 10017 (Tel: MO 1-3420);

80 rue de Namur, Bruxelles 1, Belgique (Tel: 12-74-61)

Oki Electric Industry Co., Ltd.

Sony Corp.

Tokyo Shibaura Electric Co., Ltd. (Toshiba), 1-1 Uchisaiwaicho, Chiyoda-ku, Tokyo (Cable: Toshiba); 530 Fifth Ave., New York, N.Y. 10036 (Tel: 587-5471); Berliner Allee 26, Duesseldorf 1, Germany (Tel: 29648-9)

Yokogawa Electric Works, Ltd.

Connectors, Terminals, Jacks, Plugs, etc.

DX Antenna Co., Ltd.

Fujitsu Limited, Furukawa Sogo Bldg., 2-8 Marunouchi, Chiyoda-ku, Tokyo (Cable: Fujitsulimited); 680 Fifth Ave., New York, N.Y. 10019 (Tel: CO 5-5360)

Hirose Electric Co., Ltd.

Hoshiden Electronics Co., Ltd.

Iizuka Electric Industry Co., Ltd.

Japan Vacuum Engineering Co., Ltd.

Mitsumi Electric Co., Ltd., 1054 Koadachi, Komae-cho, Kitatama-gun, Tokyo (Cable: Mparts Tokyochofu); 11 Broadway, New York, N.Y. 10004 (Tel: HA 5-3085); Marienstrasse 12, Duesseldorf, Germany

Nippon Electric Co., Ltd., 7-15 Shiba Gochome, Minato-ku, Tokyo (Cable: Microphone); 200 Park Ave., New York, N.Y. 10017 (Tel: MO 1-3420); 80 rue de Namur, Bruxelles 1, Belgique (Tel: 12-74-61)

Oki Electric Industry Co., Ltd.

Showa Musen Kogyo Co., Ltd., 6-5-5 Togoshi, Shinagawa-ku, Tokyo (Cable: Showamusen)

Converters, Choppers, Inverters, etc.

Anritsu Electric Co., Ltd., 4-12-20 Minami-azabu, Minato-ku, Tokyo (Cable: Anritdenki)

DX Antenna Co., Ltd.

Fujitsu Limited

Hokuyo Electric Industry Co., Ltd.

Nippon Electric Co., Ltd., 7-15 Shiba Gochome, Minato-ku, Tokyo (Cable: Microphone); 200 Park Ave., New York, N.Y. 10017 (Tel: MO 1-3420); 80 rue de Namur, Bruxelles 1, Belgique (Tel: 12-74-61)

Ohkura Electric Co., Ltd.

Tateisi Electronics Co., Ltd.

Toritsu Tsushin Kogyo Co., Ltd., 5-20-8 Nishi-Gotanda, Shinagawa-ku, Tokyo

Cores

Fuji Electrochemical Co., Ltd., Hamagomu Bldg., 5-11-36 Shimbashi, Minato-ku, Tokyo (Cable: Noveldrycell); 537 Fifth Ave., New York, N.Y. 10016 (Tel: LE 2-5630); Neuerwall 34, Hamburg 36, Germany

Nichiwa Sangyo Co., Ltd.

Nippon Electric Co., Ltd., 7-15 Shiba Gochome, Minato-ku, Tokyo (Cable: Microphone); 200 Park Ave., New

SMK HIGH RELIABILITY Electronic Components AVAILABLE TODAY!

Power Jacks

XH-3504

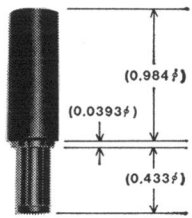

CG-9010

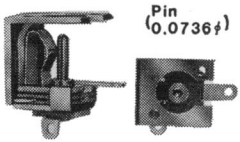

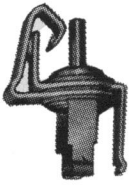

SOG-0122

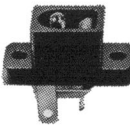

XG-9212

Unit: Inches

MAIN PRODUCTS:

- Plugs
- Fuse Holders
- Jacks
- Lamp Sockets
- Switches
- Binding Posts
- Connectors
- Other Components

● For further, please write to:

SHOWA MUSEN KOGYO CO., LTD.
No. 5-5, 6-chome, Togoshi, Shinagawa-ku, Tokyo, Japan
Phone: 783-1171 Cables: "SHOWAMUSEN" Tokyo

**NEW VALUE
Added to
-TR-5578C
Universal Counters
by Combining
Human and
Electronic
Engineering...
Low Cost, Easy to
Operate, Com-
plete Plug-in Units**

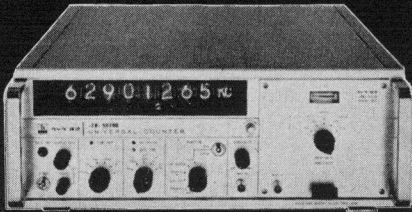

FEATURES

■ Direct Counting Speed: 62MHz
 ■ Measures Frequency 10Hz to 1020MHz (wider range available in near future) ■ High Quality and Reliability by adopting Modular System ■ Measures Frequency, Period, Frequency Ratio, Time Interval, Voltage (DC), and performs High Speed Totalizing

SPECIFICATIONS

■ Frequency Measurements □ Range: 10Hz to 62MHz (without plug-ins), 61 to 520MHz (with -TR-3012M), 201 to 1020MHz (with -TR-3014M), 101MHz to 15GHz (with -TR-3012M and -TR-3101) □ Accuracy: ± 1 count \pm time base accuracy ■ Period Measurements □ Range: 10⁻⁵Hz to 1MHz □ Gate Time: 1, 10, 100, 1000, 10000 period of unknown ■ Frequency Ratio Measurements □ Range: A/B = (1/1 to 10⁹/1) × 1, 10, 100, 1000, 10000 ■ Time Interval Measurements □ Range: 1.0μs to 10⁵s (with -TR-4011) ■ DC Voltage Measurements □ Range: $\pm 0.1, 1, 10, 100, 1000V$ DC f. s. (with -TR-6025M) ■ General □ Stability: 3×10^{-9} /day after initial stabilization □ Power: 100/115/200/230 $\pm 10\%$, 50/60Hz, approx. 100VA □ Dimension: 16¹/₂" (w) × 5⁷/₈" (h) × 17¹/₄" (d) □ Weight: Net 39 lbs (without plug-ins)

For further details, write to:

**Takeda Riken
Industry Co., Ltd.**

285, Asahi-cho, Nerima-ku, Tokyo, Japan
 Cables: TRITRONICS TOKYO Phones: 930-4111

York, N.Y. 10017 (Tel: MO 1-3420);
 80 rue de Namur, Bruxelles 1, Belgique
 (Tel: 12-74-61)

Nippon Ferrite Industrial Co., Ltd.
 Sony Corp.

TDK Electronics Co., Ltd., 2-14-6 Uchi-
 Kanda, Chiyoda-ku, Tokyo (Cable: Tdkcore); 82 Wall St., New York, N.Y. 10005 (Tel: 425-7070)

Tohoku Metal Industries, Ltd., 7-4 Ginza-
 Higashi, Chuo-ku, Tokyo (Cable: Toho-
 kumetal)

Counters

Anritsu Electric Co., Ltd., 4-12-20 Minami-
 azabu, Minato-ku, Tokyo (Cable: An-
 ritdenki)

Aoba Seiki Seisakusho Co., Ltd.

Hokuyo Electric Industry Co., Ltd.

Iwasaki Communication Apparatus Co.,
 Ltd., 2-710 Kugayama, Suginami-ku,
 Tokyo (Cable: Telephiwasaki)

Kinsekisha Laboratory, Ltd.

Takeda Riken Industry Co., Ltd., 285
 Asahi-cho, Nerima-ku, Tokyo (Cable: T-
 ritrronics)

Tokyo Denpa Co., Ltd. (Tokyo Electric
 Wave), 5-6-11 Chuo, Ohta-ku, Tokyo
 (Cable: Tewdenpa)

Yokogawa Electric Works, Ltd.

Crystals and Oscillators

Anritsu Electric Co., Ltd., 4-12-20 Min-
 ami-azabu, Minato-ku, Tokyo (Cable: An-
 ritdenki)

Fujitsu Limited

Kinsekisha Laboratory, Ltd., 2-17-23
 Miyasaka, Setagaya-ku, Tokyo (Cable: C-
 rystal)

Nippon Electric Co., Ltd., 7-15 Shiba
 Gochome, Minato-ku, Tokyo (Cable: M-
 icrophone); 200 Park Ave., New
 York, N.Y. 10017 (Tel: MO 1-3420);
 80 rue de Namur, Bruxelles 1, Belgique
 (Tel: 12-74-61)

Tohoku Metal Industries, Ltd., 7-4
 Ginza-Higashi, Chuo-ku, Tokyo (Cable: T-
 ohokumetal)

Tokyo Denpa Co., Ltd. (Tokyo Electric
 Wave), 5-6-11 Chuo, Ohta-ku, Tokyo
 (Cable: Tewdenpa)

Tokyo Shibaura Electric Co., Ltd.
 (Toshiba), 1-1 Uchisaiwaicho, Chiyoda-
 ku, Tokyo (Cable: Toshiba); 530
 Fifth Ave., New York, N.Y. 10036 (Tel:
 587-5471); Berliner Allee 26, Duessel-
 dorf 1, Germany (Tel: 29648-9)

Toyo Communication Equipment Co.,
 Ltd., Toranomon Bldg., 15 Shiba-
 Toranomon, Minato-ku, Tokyo (Cable: E-
 xportoyocom)

Delay Lines

Fujitsu Limited

Kinsekisha Laboratory, Ltd.

Mitsumi Electric Co., Ltd., 1056 Ko-
 a-dachi, Komae-cho, Kitatama-gun, Tokyo
 (Cable: Mparts Tokyochofu); 11 Broad-
 way, New York, N.Y. 10004 (Tel: HA
 5-3085); Marienstrasse 12, Duessel-
 dorf, Germany

Nippon Electric Co., Ltd., 7-15 Shiba
 Gochome, Minato-ku, Tokyo (Cable:
 Microphone); 200 Park Ave., New
 York, N.Y. 10017 (Tel: MO 1-3420);
 80 rue de Namur, Bruxelles 1, Bel-
 gique (Tel: 12-74-61)

Oki Electric Industry Co., Ltd.

Educational Equipment

Hayakawa Electric Co., Ltd., Abeno-ku,
 Osaka (Cable: Labomet); Sharp Elec-
 tronics Corp., 178 Commerce Rd.,
 Carlstadt, N.J. (Tel: 201-933-4200);
 Hohe Bleichen 16, 2 Hamburg 36,
 Germany

Ikegami Tsushinki Co., Ltd.

Nippon Electric Co., Ltd., 7-15 Shiba
 Gochome, Minato-ku, Tokyo (Cable:
 Microphone); 200 Park Ave., New
 York, N.Y. 10017 (Tel: MO 1-3420);
 80 rue de Namur, Bruxelles 1, Belgique
 (Tel: 12-74-61)

Nissin Electronics Co., Ltd.

Sony Corp., 351 Kitashinagawa-6, Shina-
 gawa-ku, Tokyo (Cable: Sonycorp)

TDS Electronics Co., Ltd., Apond Bldg.,
 1-7-12 Soto-Kanda, Chiyoda-ku, Tokyo
 (Cable: Tdselectronics)

Tateisi Electronics Co., Ltd.

Tokyo Denpa Co., Ltd. (Tokyo Electric
 Wave), 5-6-11 Chuo, Ohta-ku, Tokyo
 (Cable: Tewdenpa)

Tokyo Shibaura Electric Co., Ltd.
 (Toshiba), 1-1 Uchisaiwaicho, Chiyoda-
 ku, Tokyo (Cable: Toshiba); 530 Fifth
 Ave., New York, N.Y. 10036 (Tel:
 587-5471); Berliner Allee 26, Duessel-
 dorf 1, Germany (Tel: 29648-9)

Toritsu Tsushin Kogyo Co., Ltd., 5-20-8
 Nishi-Gotanda, Shinagawa-ku, Tokyo
 Yokogawa Electric Works, Ltd.

Filters

Anritsu Electric Co., Ltd., 4-12-20 Minami-
 azabu, Minato-ku, Tokyo (Cable: An-
 ritdenki)

Fujitsu Limited

Japan Electronic Instrument Co., Ltd.

Kinsekisha Laboratory, Ltd., 2-17-23
 Miyasaka, Setagaya-ku, Tokyo
 (Cable: Crystal)

Kokusai Electric Co., Ltd., 9 Nishikubo-
 Sakuragawa-cho, Minato-ku, Tokyo
 (Cable: Sineshiba)

Matsushita Electric Industrial Co., Ltd.,
 Electronic Components Div., Osaka;
 Matsushita Electric Corp. of America,
 200 Park Ave., New York, N.Y. 10017
 (Tel: 973-5710); Jungfernstieg 40, 2
 Hamburg 36, Germany (Tel: 344743)

Mitsumi Electric Co., Ltd.

Murata Mfg. Co., Ltd.

Nippon Electric Co., Ltd., 7-15 Shiba
 Gochome, Minato-ku, Tokyo (Cable:
 Microphone); 200 Park Ave., New
 York, N.Y. 10017 (Tel: MO 1-3420);
 80 rue de Namur, Bruxelles 1, Belgique
 (Tel: 12-74-61)

Oki Electric Industry Co., Ltd.

TDK Electronics Co., Ltd., 2-14-6 Uchi-
 Kanda, Chiyoda-ku, Tokyo (Cable:

Tdkcore); 82 Wall St., New York, N.Y. 10005 (Tel: 425-7070)

Tohoku Metal Industries, Ltd., 7-4 Ginza-Higashi, Chuo-ku, Tokyo (Cable: Tohokumetal)

Tokyo Denpa Co. Ltd. (Tokyo Electric Wave), 5-6-11 Chuo, Ohta-ku, Tokyo (Cable: Tewdenpa)

Toritsu Tsushin Kogyo Co., Ltd., 5-20-8 Nishi-Gotanda, Shinagawa-ku, Tokyo

Toyo Communication Equipment Co., Ltd., Toranomom Bldg., 15 Shiba-Toranomon, Minato-ku, Tokyo (Cable: Exportoyocom)

Fuses, Circuit Breakers, Over-load Devices, etc.

Fujitsu Limited

Nichicon Capacitor, Ltd.

Nissin Electronics Co., Ltd.

Showa Musen Kogyo Co., Ltd.

Taiyo Electronics Corp., 6-5-1 Togoshi, Shinagawa-ku, Tokyo (Cable: Apolohagita)

Tateisi Electronics Co., Ltd.

Tokyo Shibaura Electric Co., Ltd. (Toshiba), 1-1 Uchisaiwaicho, Chiyoda-ku, Tokyo (Cable: Toshiba); 530 Fifth Ave., New York, N.Y. 10036 (Tel: 587-5471); Berliner Allee 26, Duesseldorf 1, Germany (Tel: 29648-9)

Geophysical Apparatus

Toyo Communication Equipment Co., Ltd.

Yanagimoto Mfg. Co., Ltd.

Hardware

Akiyoshi Electric Co., Ltd. (shafts, knobs)

KCC Shokai, Ltd., 4-71 Kita-dori, Nada-ku, Kobe (Cable: Wmkkc Kobe); 35-60 74th, Jackson Heights, N.Y.

Ogura Jewel Industrial Co., Ltd.

Showa Musen Kogyo Co., Ltd., 6-5-5 Togoshi, Shinagawa-ku, Tokyo (Cable: Showamusen)

Heating and Welding Equipment

Japan Vacuum Engineering Co., Ltd.

Kokusai Electric Co., Ltd., 9 Nishikubo-Sakuragawa-cho, Minato-ku, Tokyo

(Cable: Sineshiba)

Sansha Electric Trading Co., Ltd.

Tokyo Shibaura Electric Co., Ltd. (Toshiba), 1-1 Uchisaiwaicho, Chiyoda-ku, Tokyo (Cable: Toshiba); 530 Fifth Ave., New York, N.Y. 10036 (Tel: 587-5471); Berliner Allee 26, Duesseldorf 1, Germany (Tel: 29648-9)

Home Appliances and Devices

Funai Electric Co., Ltd.

Hayakawa Electric Co., Ltd., Abeno-ku, Osaka (Cable: Labomet); Sharp Electronics Corp., 178 Commerce Rd., Carlstadt, N.J. (Tel: 291-933-4200); Hohe Bleichen 16, 2 Hamburg 36, Germany

Hitachi, Ltd.

Hokuyo Musen Kogyo Co., Ltd.

Katsuragawa Electric Co., Ltd.

Kobe Industries Corp. (auto radios)

Matsunaga International, Ltd.

Nippon Electric Co., Ltd., 7-15 Shiba Gochome, Minato-ku, Tokyo (Cable: Microphone); 200 Park Ave., New York, N.Y. 10017 (Tel: MO 1-3420); 80 rue de Namur, Bruxelles 1, Belgique (Tel: 12-74-61)

Osaka Onkyo Co., Ltd., 5-32 Ohmiya Nishinocho, Asahi-ku, Osaka (Cable: Onkyo Osaka); JEG, Stegstrasse 34, 6000 Frankfurt, Germany (Tel: 61-35-95) (auto radios)

Tensho Electric Industries Co., Ltd. (record players)

Tokyo Shibaura Electric Co., Ltd. (Toshiba), 1-1 Uchisaiwaicho, Chiyoda-ku, Tokyo (Cable: Toshiba); 530 Fifth Ave., New York, N.Y. 10036 (Tel: 587-5471); Berliner Allee 26, Duesseldorf 1, Germany (Tel: 29648-9)

Indicator Lamps and Displays

Fujitsu Limited

Nippon Electric Co., Ltd., 7-15 Shiba Gochome, Minato-ku, Tokyo (Cable: Microphone); 200 Park Ave., New York, N.Y. 10017 (Tel: MO 1-3420); 80 rue de Namur, Bruxelles 1, Belgique (Tel: 12-74-61)

Tateisi Electronics Co., Ltd.

10.7Mc Crystal Filter from K. S. S.

This is designed for use in FM receivers to especially maintain excellent characteristics in Temperature and Shock.

The main characteristics of the standard 10.7Mc crystal filters are shown below.

Type	Center Freq.	6 db Bandwidth Min.	Bandwidth max.	Insertion Loss max.	In & S Output Impedance Ohms	Dimensions % J W H
KFD-15 K	10.7MC	30K C	75db 50K C	6 db	2 K	70 x 22 x 22
KFE-15 K	10.7	30	60db 60K C	6	2 K	46 x 22 x 22
KFE-7.5K	10.7	15	60db 30K C	5	1 K	35 x 22 x 22
KFF-6 K	10.7	12	60db 34K C	5	1 K	35 x 22 x 22
KFF-15 K	10.7	30	75db 50K C	5	2 K	24 x 22 x 22
KFG-15 K	10.7	30	40db 100K C	3	2 K	24 x 22 x 22

Operating Temp. Range -20 - +60 C

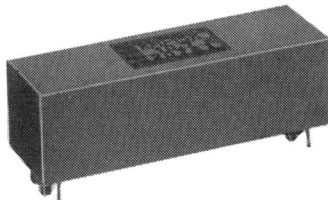

For catalog, write to:

Kinsekisha Laboratory Ltd.

Tel. 429-2111 Cables: CRYSTAL TOKYO

23-17, Miyasaka 2-chome, Setagaya-ku, Tokyo, Japan

KOKUSAI'S

MECHANICAL FILTER

50cps..... 500kc



LOW FREQUENCY ML SERIES

300cps.....50kc
Percent Bandwidth 0.1%.....10%
Low Impedance Termination

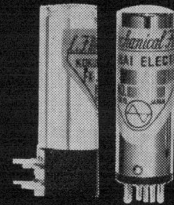

LOW FREQUENCY FK SERIES

100cps 6kc
Available as filter and oscillator

Telecontrol and Telemetry use

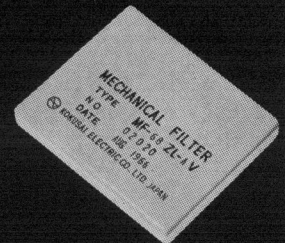
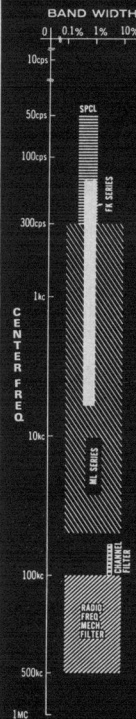

V x 12 CHANNEL FILTER

64kc.....108kc
Carrier telephone terminal equipment application



RADIO FREQUENCY MECHANICAL FILTER

100kc.....500kc

SSB, AM, FM, TRANSCEIVER use



Patented in France, Federal Republic of Germany, Great Britain, U.S.A. and Japan

KOKUSAI ELECTRIC CO., LTD.

9, Nishikubo-Sakuragawa-cho, Minato-ku, Tokyo, Japan
Cable Address: SINESHIBA TOKYO

FREQUENCY SYNTHESIZER

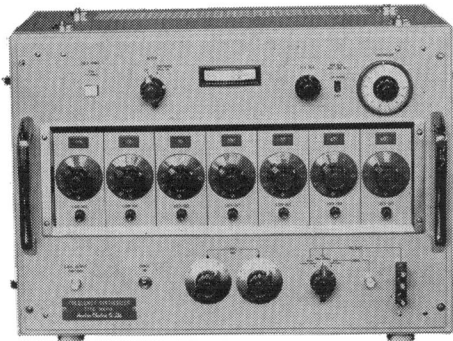

MG31A 10Hz - 1MHz \$ 4,229

- Frequency setting
 - 0.01Hz to 10kHz steps 10Hz~100kHz
 - 0.1Hz to 100kHz steps 10Hz~1MHz & continuously variable
- Output level accuracy ± 0.2 dB
- Output Impedance
 - 75 Ω Unbalance 10Hz~1MHz
 - 75 Ω Balance 10kHz~650kHz
 - 600 Ω Balance 300Hz~150kHz

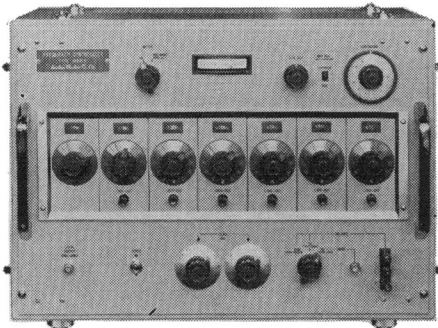

MG41A 200Hz - 30MHz \$ 4,229

- Frequency setting 10Hz to 10MHz steps & continuously variable
- Output level accuracy ± 0.2 dB at 1MHz, +5dBm
- Output Impedance
 - 75 Ω Unbalance 200Hz~30MHz
 - 75 Ω Balance 10kHz~650kHz
 - 600 Ω Balance 300Hz~150kHz

General

- Frequency stability 5×10^{-8} / day
- Output level -50 ~ +15 dBm 1dB, 5dB steps
- Frequency sweep Available by external input DC ~ 50Hz
- Dimensions & weight 370 x 520 x 315 mm, 30kg

Prices f. o. b. Yokohama

Anritsu Electric Co., Ltd.

4-12-20, Minamiazabu, Minato-ku, Tokyo
cable address ANRITDENKI TOKYO

Insulation

Murata Mfg. Co., Ltd.
Nitto Electric Industrial Co. Ltd.
Risho Kogyo Co., Ltd.
Tokyo Shibaura Electric Co., Ltd. (Toshiba), 1-1 Uchisaiwaicho, Chiyoda-ku, Tokyo (Cable: Toshiba); 530 Fifth Ave., New York, N.Y. 10036 (Tel: 587-5471); Berliner Allee 26, Duesseldorf 1, Germany (Tel: 29648-9)

Lighting Equipment

KCC Shokai, Ltd., 4-71 Kita-dori, Nada-ku, Kobe (Cable: Wmcc Kobe); 35-60 74th, Jackson Heights, N.Y. (switchboards)
Shindengen Electric Mfg. Co., Ltd. (dimers)
Tokyo Shibaura Electric Co., Ltd. (Toshiba), 1-1 Uchisaiwaicho, Chiyoda-ku, Tokyo (Cable: Toshiba); 530 Fifth Ave., New York, N.Y. 10036 (Tel: 587-5471); Berliner Allee 26, Duesseldorf 1, Germany (Tel: 29648-9)

Machinery and Tools

Hitachi, Ltd.
Kobe Industries Co., Ltd.
Tokyo Seimitsu Co., Ltd.
Tokyo Shibaura Electric Co., Ltd. (Toshiba), 1-1 Uchisaiwaicho, Chiyoda-ku, Tokyo (Cable: Toshiba); 530 Fifth Ave., New York, N.Y. 10036 (Tel: 587-5471); Berliner Allee 26, Duesseldorf 1, Germany (Tel: 29648-9)

Magnets, Magnetic Materials, Magnetic Equipment

Murata Mfg. Co., Ltd.
Neo Ark Science & Technology, Inc., 1-23 Wakamatsu-cho, Fuchu-city, Tokyo (Cable: Neoark Fuchu)
Nichiwa Sangyo Co., Ltd.
Nippon Electric Co., Ltd., 7-15 Shiba Gochome, Minato-ku, Tokyo (Cable: Microphone); 200 Park Ave., New York, N.Y. 10017 (Tel: MO 1-3420); 80 rue de Namur, Bruxelles 1, Belgique (Tel: 12-74-61)

Nippon Ferrite Industrial Co., Ltd.
Sony Corp., 351 Shinagawa-6, Shinagawa-ku, Tokyo (Cable: Sonycorp)
Sumitomo Special Metals Co., Ltd.
TDK Electronics Co., Ltd., 2-14-6 Uchi-Kanda, Chiyoda-ku, Tokyo (Cable: Tdkcore); 82 Wall St., New York, N.Y. 10005 (Tel: 425-7070)

TDS Electronics Co., Ltd., Apond Bldg., 1-7-12 Soto-Kanda, Chiyoda-ku, Tokyo (Cable: Tdselectronics)
Tohoku Metal Industries, Ltd., 7-4 Ginza-Higashi, Chuo-ku, Tokyo (Cable: Tohokumetal)
Toritsu Tsushin Kogyo Co., Ltd., 5-20-8 Nishi-Gotanda, Shinagawa-ku, Tokyo
Yokogawa Electric Works, Ltd.

Marine and Underwater Equipment

Kobe Industries Corp.
Nippon Electric Co., Ltd.

Materials and Metals

Hitachi, Ltd.
KCC Shokai, Ltd., 4-71 Kita-dori, Nada-ku, Kobe (Cable: Wmcc Kobe); 35-60 74th, Jackson Heights, N.Y.
Nichiwa Sangyo Co., Ltd.
Osaka Titanium Co., Ltd.
Sumitomo Special Metals Co., Ltd.
Tohoku Metal Industries, Ltd., 704 Ginza-Higashi, Chuo-ku, Tokyo (Cable: Tohokumetal)
Tokyo Shibaura Electric Co., Ltd. (Toshiba), 1-1 Uchisaiwaicho, Chiyoda-ku, Tokyo (Cable: Toshiba); 530 Fifth Ave., New York, N.Y. 10036 (Tel: 587-5471); Berliner Allee 26, Duesseldorf 1, Germany (Tel: 29648-9)

Measuring Instruments and Standards

Anritsu Electric Co., Ltd., 4-12-20 Minami-azabu, Minato-ku, Tokyo (Cable: Anritdenki)
Horiba Instruments, Inc.
Ikegami Tsushinki Co., Ltd.
Iwasaki Communication Apparatus Co., Ltd., 2-710 Kugayama, Suginami-ku, Tokyo (Cable: Telephiwasaki)
Izumi Denki Co., Ltd.
Japan Electronic Instrument Co., Ltd. (Standards)
Japan Vacuum Engineering Co., Ltd.
Kobe Industries Co., Ltd.
Meguro Denpa Sokki Co., Ltd.
Metronix Corp.
Mitutoyo Mfg. Co., Ltd.
Neo Ark Science & Technology, Inc., 1-23 Wakamatsu-cho, Fuchu-city, Tokyo (Cable: Neoark Fuchu)
Nippon Coil Co., Ltd.
Nippon Electric Co., Ltd., 7-15 Shiba Gochome, Minato-ku, Tokyo (Cable: Microphone); 200 Park Ave., New York, N.Y. 10017 (Tel: MO 1-3420); 80 rue de Namur, Bruxelles 1, Belgique (Tel: 12-74-61)
Ohkura Electric Co., Ltd.
Oki Electric Industry Co., Ltd.
Primo Company, Ltd.
Shibaura Electronics Co., Ltd.
TDS Electronics Co., Ltd., Apond Bldg., 1-7-12 Soto-Kanda, Chiyoda-ku, Tokyo (Cable: Tdselectronics) (ESR's)
Takeda Riken Industry Co., Ltd., 285 Asahi-cho, Nerima-ku, Tokyo (Cable: Tritronics)
Tateisi Electronics Co., Ltd.
Tokyo Denpa Co., Ltd. (Tokyo Electric Wave), 5-6-11 Chuo, Ohta-ku, Tokyo (Cable: Tewdenpa)
Tokyo Seimitsu Co., Ltd.
Tokyo Shibaura Electric Co., Ltd. (Toshiba), 1-1 Uchisaiwaicho, Chiyoda-ku, Tokyo (Cable: Toshiba); 530 Fifth Ave., New York, N.Y. 10036 (Tel: 587-5471); Berliner Allee 26, Duesseldorf 1, Germany (Tel: 29648-9)
Tsuda Electric Meters Co., Ltd.
Vibration Development Co., Ltd.
Yanagimoto Mfg. Co., Ltd.
Yokogawa Electric Works, Ltd.

Meters and Indicators

Fujitsu Limited
 Hirai Denkeiki Co., Ltd.
 Hokuyo Electric Industrial Co., Ltd.
 Horiba Instruments, Inc.
 Meguro Denpa Sokki Co., Ltd.
 Mitaka Electrical Instrument Works
Nippon Electric Co., Ltd., 7-15 Shiba Gochome, Minato-ku, Tokyo (Cable: Microphone); 200 Park Ave., New York, N.Y. 10017 (Tel: MO 1-3420); 80 rue de Namur, Bruxelles 1, Belgique (Tel: 12-74-61)
 Ohkura Electric Co., Ltd.
 Primo Company, Ltd.
Takeda Riken Industry Co., Ltd., 285 Asahi-cho, Nerima-ku, Tokyo (Cable: Tritronics)
 Tateishi Electronics Co., Ltd.
 Tokyo Seimitsu Co., Ltd.
Tokyo Shibaura Electric Co., Ltd. (Toshiba), 1-1 Uchisaiwaicho, Chiyoda-ku, Tokyo (Cable: Toshiba); 530 Fifth Ave., New York, N.Y. 10036 (Tel: 587-5471); Berliner Allee 26, Duesseldorf 1, Germany (Tel: 29648-9)
Toyo Musen Co., Ltd., 1-8-10 Wakabayashi, Setagaya-ku, Tokyo (Cable: Toyoradicator); 938 Merchandise Mart, Chicago, Ill. 60654
 Tsuda Electric Meters Co., Ltd.
 Vibration Development Co., Ltd.
 Yokogawa Electric Works, Ltd.

Microphones

Foster Electric Co., Ltd., 512 Miyazawamachi, Akishima-city, Tokyo (Cable: Foster Akishima); 230 N. Michigan Ave., Chicago, Ill.
 Hoshiden Electronics Co., Ltd.
Nippon Electric Co., Ltd., 7-15 Shiba Gochome, Minato-ku, Tokyo (Cable: Microphone); 200 Park Ave., New York, N.Y. 10017 (Tel: MO 1-3420); 80 rue de Namur, Bruxelles 1, Belgique (Tel: 12-74-61)
Primo Company, Ltd., 2043 Mure, Mitakacity, Tokyo (Cable: Primo Musashino Mitaka); Suite No. 204, 530 W. Surf St., Chicago, Ill. 60657 (Tel: 312-472-6142)
Sony Corp., 351 Kitashinagawa-6, Shinagawa-ku, Tokyo (Cable: Sonycorp)
Tokyo Shibaura Electric Co., Ltd. (Toshiba), 1-1 Uchisaiwaicho, Chiyoda-ku, Tokyo (Cable: Toshiba); 530 Fifth Ave., New York, N.Y. 10036 (Tel: 587-5471); Berliner Allee 26, Duesseldorf 1, Germany (Tel: 29648-9)

Microwave, Radar and Telemetering Equipment

Anritsu Electric Co., Ltd., 4-12-20 Minami-azabu, Minato-ku, Tokyo (Cable: Anritdenki)
Fujitsu Limited, Furukawa Sogo Bldg., 2-8 Marunouchi, Chiyoda-ku, Tokyo (Cable: Fujitsulimited); 680 Fifth Ave., New York, N.Y. 10019 (Tel: CO 5-5360)

Kobe Industries Corp.
Neo Ark Science & Technology, Inc., 1-23 Wakamatsu-cho, Fuchu-city, Tokyo (Cable: Neoark Fuchu)
Nippon Electric Co., Ltd., 7-15 Shiba Gochome, Minato-ku, Tokyo (Cable: Microphone); 200 Park Ave., New York, N.Y. 10017 (Tel: MO 1-3420); 80 rue de Namur, Bruxelles 1, Belgique (Tel: 12-74-61)
 Ohkura Electric Co., Ltd. (telemetering)
TDS Electronics Co., Ltd., Apond Bldg., 1-7-12 Soto-Kanda, Chiyoda-ku, Tokyo (Cable: Tdselectronics)
Takeda Riken Industry Co., Ltd., 285 Asahi-cho, Nerima-ku, Tokyo (Cable: Tritronics)
Tokyo Shibaura Electric Co., Ltd. (Toshiba), 1-1 Uchisaiwaicho, Chiyoda-ku, Tokyo (Cable: Toshiba); 530 Fifth Ave., New York, N.Y. 10036 (Tel: 587-5471); Berliner Allee 26, Duesseldorf 1, Germany (Tel: 29648-9)

Microwave Components and Waveguides

Fujitsu Limited
Neo Ark Science & Technology, Inc., 1-23 Wakamatsu-cho, Fuchu-city, Tokyo (Cable: Neoark Fuchu)
Nippon Electric Co., Ltd., 7-15 Shiba Gochome, Minato-ku, Tokyo (Cable: Microphone); 200 Park Ave., New York, N.Y. 10017 (Tel: MO 1-3420); 80 rue de Namur, Bruxelles 1, Belgique (Tel: 12-74-61)
 Oki Electric Industry Co., Ltd.
TDS Electronics Co., Ltd., Apond Bldg., 1-7-12 Soto-Kanda, Chiyoda-ku, Tokyo (Cable: Tdselectronics)
Tokyo Shibaura Electric Co., Ltd. (Toshiba), 1-1 Uchisaiwaicho, Chiyoda-ku, Tokyo (Cable: Toshiba); 530 Fifth Ave., New York, N.Y. 10036 (Tel: 587-5471); Berliner Allee 26, Duesseldorf 1, Germany (Tel: 29648-9)

Military Devices

Fujitsu Limited
 Kobe Industries Corp.
Nippon Electric Co., Ltd., 7-15 Shiba Gochome, Minato-ku, Tokyo (Cable: Microphone); 200 Park Ave., New York, N.Y. 10017 (Tel: MO 1-3420); 80 rue de Namur, Bruxelles 1, Belgique (Tel: 12-74-61)
Toritsu Tsushin Kogyo Co., Ltd., 5-20-8 Nishi-Gotanda, Shinagawa-ku, Tokyo
 Toyo Communication Equipment Co., Ltd.

Motors, Generators, Prime Movers

Fujitsu Limited, Furukawa Sogo Bldg., 2-8 Marunouchi, Chiyoda-ku, Tokyo (Cable: Fujitsulimited); 680 Fifth Ave., New York, N.Y. 10019 (Tel: CO 5-5360)
 Hachiman Electronic Works, Ltd. (synchro)
 Hitachi, Ltd.

RADICATOR®?

It's super micro indicator

V-44

260µA
 2/3 scale
 410 Ω

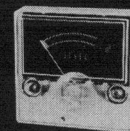

V-41

260µA
 2/3 scale
 410 Ω

V-14B

260µA
 2/3 scale
 500 Ω



A-81

500µA
 Full scale
 410 Ω



TOYO MUSEN CO., LTD.

1-8-10, Wakabayashi, Setagaya-ku, Tokyo, Japan
 Telex: Tokyo 242-2572
 Cable Address: TOYORADICATOR

Isao Hironaka c/o Marubeni-lida (America), Inc.
 Chicago Office 938 Merchandise Mart, Chicago, Illinois
 60654 U.S.A.

Primo

NEW!
 CARDIOID DYNAMIC
 MICROPHONE
 (Slim, Pop-out type)



UD-857

Provided with
 ★ Tone Controller
 ★ Wind Screen (inside)
 ★ Switch

Designed specifically for stage, broadcast applications.

SPECIFICATIONS

- Cartridge: DM-33
- Frequency Response: 50~15,000c/s ±5dB
- Impedance: 600 ohm
- Sensitivity: -72dB/dyne /cm.cm (0.25mV)
- Net Weight: 430g
- Finish: Chrome hair lined

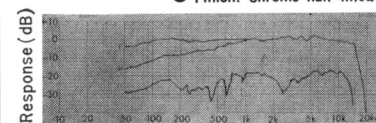

For catalog write to

PRIMO COMPANY LTD.

Chicago Illinois Office:
 A.P.T. No.204, 530 W. Surf. St., Chicago Illinois
 60657, U.S.A. Tel. 312-472-61421

Head Office:
 2043 MURE, MITAKASHI, TOKYO, JAPAN
 TEL 0422-43-3121~6 CABLES: "Primo Musashino Mitaka"
 TELEX: 2822-326 PRIMO MUS

Tall to flat

A new trend among engineers who hate to create average tape-recorders

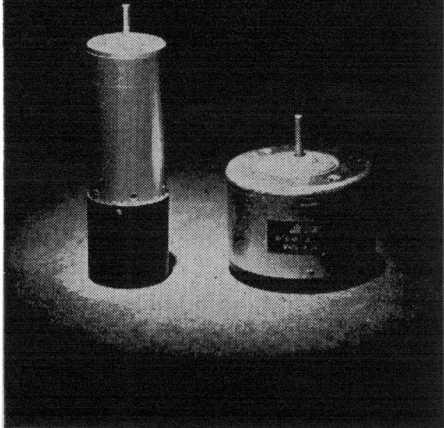

Today many engineers specify the new Mitsumi extra flat micro-motors for their tape-recorders, or record players. It gives you more flexibility in machine design.

Mitsumi micro motors eliminate starting error, minimize noise, provide long life, stable performance against change in temperature and humidity, and excellent regulation. Efficiency is over 50% which has always been considered impossible for a motor as small as 20mm in diameter. Advanced, yet simple, designs for easy mounting and wiring.

Ask for Mitsumi when you need a reliable, quality micro motor for portable tape-recorders, record-players, measuring instruments and 8mm 2-speed movie cameras. Over 30 types of AC or DC micro motors are immediately available.

MAIN PRODUCTS

- Polyethylene variable capacitors ● IF Transformers
- Micromotors ● Synchronous motors ● Front-end FM tuners ● UHF & VHF TV tuners ● CdS photoconductive cells ● Trimming potentiometers ● Various types of coils ● Various types of sockets ● Trimmer capacitors ● Various types of terminals ● Fuse holders



MITSUMI

MITSUMI ELECTRIC COMPANY LIMITED

1056 Koadachi, Komae-machi, Tokyo. 415-6211
302, Cheong Hing Bldg., 72 Nathan Road, Kowloon, Hong Kong. 666-925
Marienstrasse 12, Dusseldorf, W. Germany.

MITSUMI ELECTRONICS CORPORATION

11 Broadway, New York 4, N.Y. 10004. HA5-6007
333 N. Michigan Avenue, Chicago, Ill. 60601 263-6007

Hokuyo Electric Industries Co., Ltd.
Hoshiden Electronics Co., Ltd.
Katsuragawa Electric Co., Ltd.
Mitsumi Electric Co., Ltd., 1056 Koadachi, Komae-cho, Kitatama-gun, Tokyo (Cable: Mparts Tokyochofu); 11 Broadway, New York, N.Y. 10004 (Tel: HA 5-3085); Marienstrasse 12, Duesseldorf, Germany
Tanita Mfg. Co., Ltd.
Tokyo Shibaura Electric Co., Ltd. (Toshiba), 1-1 Uchisaiwaicho, Chiyoda-ku, Tokyo (Cable: Toshiba); 530 Fifth Ave., New York, N.Y. 10036 (Tel: 587-5471); Berliner Allee 26, Duesseldorf 1, Germany (Tel: 29648-9)
Yaskawa Electric Mfg. Co., Ltd.

Nuclear Equipment

Horiba Instruments, Inc.
Japan Vacuum Engineering Co., Ltd.
Kobe Industries Corp.
Ohkura Electric Co., Ltd.
TDS Electronics Co., Ltd., Apond Bldg., 1-7-12 Soto-Kanda, Chiyoda-ku, Tokyo (Cable: Tdselectronics)
Takeda Riken Industry Co., Ltd., 285 Asahi-cho, Nerima-ku, Tokyo (Cable: Tritronics)
Tateisi Electronics Co., Ltd.
Tokyo Shibaura Electric Co., Ltd. (Toshiba), 1-1 Uchisaiwaicho, Chiyoda-ku, Tokyo (Cable: Toshiba); 530 Fifth Ave., New York, N.Y. 10036 (Tel: 587-5471); Berliner Allee 26, Duesseldorf 1, Ger-

many (Tel: 29648-9)
Yanagimoto Mfg. Co., Ltd.

Optical Equipment, Lasers, Infrared, etc.

Canon Camera Co., Ltd.
Fujitsu Limited
Horiba Instruments, Inc. (infrared)
Ichizuka Optical Co., Ltd., 2-568 Shimo-ochiai, Shinjuku-ku, Tokyo (Cable: Moviekino) (lenses)
Kobe Industries Corp.
Neo Ark Science & Technology, Inc., 1-23 Wakamatsu-cho, Fuchu-city, Tokyo (Cable: Neorark Fuchu) (gas lasers)
Nippon Electric Co., Ltd., 7-15 Shiba Gochome, Minato-ku, Tokyo (Cable: Microphone); 200 Park Ave., New York, N.Y. 10017 (Tel: MO 1-3420); 80 rue de Namur, Bruxelles 1, Belgique (Tel: 12-74-61)
Shinko Seiki Co., Ltd. (comparators)
TDS Electronics Co., Ltd., Apond Bldg., 1-7-12 Soto-Kanda, Chiyoda-ku, Tokyo (Cable: Tdselectronics)
Takeda Riken Industry Co., Ltd., 285 Asahi-cho, Nerima-ku, Tokyo (Cable: Tritronics)
Tokyo Shibaura Electric Co., Ltd. (Toshiba), 1-1 Uchisaiwaicho, Chiyoda-ku, Tokyo (Cable: Toshiba); 530 Fifth Ave., New York, N.Y. 10036 (Tel: 587-5471); Berliner Allee 26, Duesseldorf 1, Germany (Tel: 29648-9)
Yokogawa Electric Works, Ltd.

Optical Materials

Tokyo Shibaura Electric Co., Ltd. (Toshiba), 1-1 Uchisaiwaicho, Chiyoda-ku, Tokyo (Cable: Toshiba), 530 Fifth Ave., New York, N.Y. 10036 (Tel: 587-5471); Berliner Allee 26, Duesseldorf 1, Germany (Tel: 29648-9)
Toyo Communication Equipment Co., Ltd., Toranomon Bldg., 15 Shiba-Toranomon, Minato-ku, Tokyo (Cable: Exportoyo-com)

Oscilloscopes and Displays

Ikegami Tsushinki Co., Ltd.
Iwasaki Communication Apparatus Co., Ltd., 2-710 Kugayama, Suginami-ku, Tokyo (Cable: Telephiwasaki)
Kobe Industries Corp.
Nippon Electric Co., Ltd., 7-15 Shiba Gochome, Minato-ku, Tokyo (Cable: Microphone); 200 Park Ave., New York, N.Y. 10017 (Tel: MO 1-3420); 80 rue de Namur, Bruxelles 1, Belgique (Tel: 12-74-61)
Sansei Electronics Corp.
TDS Electronics Co., Ltd., Apond Bldg., 1-7-12 Soto-Kanda, Chiyoda-ku, Tokyo (Cable: Tdselectronics)
Tokyo Shibaura Electric Co., Ltd. (Toshiba), 1-1 Uchisaiwaicho, Chiyoda-ku, Tokyo (Cable: Toshiba); 530 Fifth Ave., New York, N.Y. 10036 (Tel: 587-5471); Berliner Allee 26, Duesseldorf 1, Germany (Tel: 29648-9)

GAS LASER EXHIBITED AT IEEE

One mirror, built-in power supply. For laboratory and production-line use.

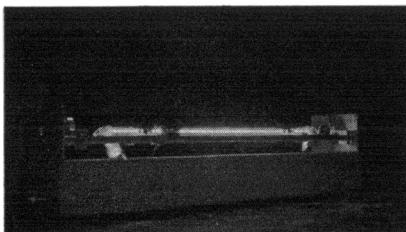

Also: Neo Ark Hystoroscope, Optoscope, wire parametrons, vacuum evaporator.

neoArk

Neo Ark Science & Technology Inc.
MICROWAVE, MAGNETISM & LASER RESEARCH
1-23 Wakamatsu-cho, Fuchu-shi, Tokyo (Cable: Neorark Fuchu)

Parts (Metal)

Showa Musen Kogyo Co., Ltd., 6-5-5
Togoshi, Shinagawa-ku, Tokyo (Cable:
Showamusen)

Plastics

Tensho Electric Industries Co., Ltd.

Potentiometers

Japan Resistor Mfg. Co., Ltd.

Matsushita Electric Industrial Co., Ltd.,
Electronic Components Div., Osaka;
Matsushita Electric Corp. of America,
200 Park Ave., New York, N.Y. 10017
(Tel: 973-5710; Jungfernstieg 40, 2
Hamburg 36, Germany (Tel: 344743)

Midori Precisions Co., Ltd.

Mitsumi Electric Co., Ltd., 1056 Koadachi,
Komae-cho, Kitatama-gun, Tokyo
(Cable: Mparts Tokyochofu); 11 Broadway,
New York, N.Y. 10004 (Tel: HA
5-3085); Marienstrasse 12, Duesseldorf,
Germany

Murata Mfg. Co., Ltd.

Nippon Electric Co., Ltd., 7-15 Shiba
Gochome, Minato-ku, Tokyo (Cable:
Microphone); 200 Park Ave., New York,
N.Y. 10017 (Tel: MO 1-3420); 80 rue de
Namur, Bruxelles 1, Belgique (Tel:
12-74-61)

Yokogawa Electric Works, Ltd.

Power Station Equipment

Furukawa Electric Co., Ltd.

Hitachi, Ltd.

Hokuyo Electric Industries Co., Ltd.

KCC Shokai, Ltd., 4-71 Kita-dori, Nada-
ku, Kobe (Cable: Wmkcc Kobe); 35-60
74th, Jackson Heights, N.Y. (cutting
ducts for panelboards)

Ohkura Electric Co., Ltd.

Tokyo Shibaura Electric Co., Ltd. (To-
shiba), 1-1 Uchisaiwaicho, Chiyoda-ku,
Tokyo (Cable: Toshiba); 530 Fifth
Ave., New York, N.Y. 10036 (Tel:
587-5471); Berliner Allee 26, Duesseld-
orf 1, Germany (Tel: 29648-9)

Tsuda Electric Meters Co., Ltd.

Power Supplies

Ikegami Tsushinki Co., Ltd., 21 Motoki,
Kawasaki-city (Cable: Iketsu Kawa-
saki); Ikegami Electronics Industries,
Inc., 501 Fifth Ave., New York, N.Y.
10017 (Tel: 867-9209)

Iwasaki Communication Apparatus Co.,
Ltd., 2-710 Kugayama, Suginami-ku,
Tokyo (Cable: Telephiwasaki)

Metronix Corp.

Sansei Electronics Corp.

Sansha Electric Trading Co., Ltd.

Sansui Electric Co., Ltd., 460 Izumi-cho,
Suginami-ku, Tokyo (Cable: Sansui-
elec)

TDS Electronics Co., Ltd., Apond Bldg.,
1-7-12 Soto-Kanda, Chiyoda-ku, Tokyo
(Cable: Tdselectronics)

Toritsu Tsushin Kogyo Co., Ltd., 5-20-8
Nishi-Gotanda, Shinagawa-ku, Tokyo

Production Equipment and Aids

Dainippon Screen Mfg. Co., Ltd. (Photo-
graphic)

Japan Vacuum Engineering Co., Ltd.

Nissin Electronics Co., Ltd. (Weight)

Space Mechatronics, Inc.

Tokyo Seimitsu Co., Ltd.

Railway and Transportation Equipment

Fujitsu Limited (Automatic train con-
trols)

Tateisi Electronics Co., Ltd.

Tokyo Shibaura Electric Co., Ltd. (To-
shiba), 1-1 Uchisaiwaicho, Chiyoda-ku,
Tokyo (Cable: Toshiba); 530 Fifth Ave.,
New York, N.Y. 10036 (Tel: 587-5471),
Berliner Allee 26, Duesseldorf 1, Ger-
many (Tel: 29648-9)

Tsuda Electric Meters Co., Ltd.

Recorders (Graphic)

Hitachi, Ltd.

Horiba Instruments, Inc.

Meguro Denpa Sokki Co., Ltd.

Ohkura Electric Co., Ltd.

Tateishi Electronics Co., Ltd.

Tokyo Seimitsu Co., Ltd.

Tokyo Shibaura Electric Co., Ltd. (To-
shiba), 1-1 Uchisaiwaicho, Chiyoda-ku,
Tokyo (Cable: Toshiba); 530 Fifth Ave.,
New York, N.Y. 10036 (Tel: 587-5471);
Berliner Allee 26, Duesseldorf 1, Ger-
many (Tel: 29648-9)

Watanabe Instruments Corp.

Yanagimoto Mfg. Co., Ltd.

Yokogawa Electric Works, Ltd.

Recording Accessories, Acoustic Components, Tape, etc.

Foster Electric Co., Ltd., 512 Miyazawa-
machi, Akishima-city, Tokyo (Cable:
Foster Akishima); 230 N. Michigan
Ave., Chicago, Ill. (professional-grade
heads)

Hachiman Electronic Works, Ltd. (heads)

Hayakawa Electric Co., Ltd., Abeno-ku,
Osaka (Cable: Labomet Osaka); Sharp
Electronics Corp., 178 Commerce Rd.,
Carlstadt, N.J. (Tel: 201-933-4200);
Hohe Bleichen 16, 2 Hamburg 36, Ger-
many

Iwasaki Communication Apparatus Co.,
Ltd., 2-710 Kugayama, Suginami-ku,
Tokyo (Cable: Telephiwasaki)

Matsushita Electric Industrial Co., Ltd.

Nippon Electric Co., Ltd., 7-15 Shiba
Gochome, Minato-ku, Tokyo (Cable:
Microphone); 200 Park Ave., New York,
N.Y. 10017 (Tel: MO 1-3420); 80 rue
de Namur, Bruxelles 1, Belgique (Tel:
12-74-61)

Pioneer Electronic Corp.

Sony Corp., 351 Kitashinagawa-6, Shina-
gawa-ku, Tokyo (Cable: Sonycorp)

TDK Electronics Co., Ltd., 2-14-6 Uchi-
Kanda, Chiyoda-ku, Tokyo (Cable:
Tdkcore); 82 Wall St., New York, N.Y.
10005 (Tel: 425-7070) (tape and heads)

Tokyo Shibaura Electric Co., Ltd. (To-
shiba), 1-1 Uchisaiwaicho, Chiyoda-ku,

yes, CCTV Cameras work best



with COSMICAR[®] LENSES

Superior cameras deserve superior lenses. COSMICAR's proven precision performance is the combined result of advanced optical engineering and exquisite workmanship.

Now widely used, COSMICAR LENSES come in 23 models for focal lengths ranging from 12.5 mm to 500 mm, and in 3 zoom models including a remote control zoom.

Your CCTV camera and COSMICAR LENSES will make an unbeatable team. For technical data and other particulars, please write.

Effective September 1, 1967,
ICHIZUKA OPTICAL CO., LTD.
changes its name to

 **COSMICAR
OPTICAL CO., LTD.**

2-568, Shimoochiai, Shinjuku-ku, Tokyo
Cable Address: "MOVIEKINO TOKYO"

Tokyo (Cable: Toshiba); 530 Fifth Ave., New York, N.Y. 10036 (Tel: 587-5471); Berliner Allee 26, Duesseldorf 1, Germany (Tel: 29648-9)

Vibration Development Co., Ltd.
Yokogawa Electric Works, Ltd.

Rectifiers

Kobe Industries Corp. (VT)

Nippon Electric Co., Ltd., 7-15 Shiba Gochome, Minato-ku, Tokyo (Cable: Microphone); 200 Park Ave., New York, N.Y. 10017 (Tel: MO 1-3420); 80 rue de Namur, Bruxelles 1, Belgique (Tel: 12-74-61)

Sansha Electric Trading Co., Ltd.

Shindegen Electric Mfg. Co., Ltd.

Tokyo Shibaura Electric Co., Ltd. (Toshiba), 1-1 Uchisaiwaicho, Chiyoda-ku, Tokyo (Cable: Toshiba); 530 Fifth Ave., New York, N.Y. 10036 (Tel: 587-5471); Berliner Allee 26, Duesseldorf 1, Germany (Tel: 29648-9)

Regulators and Controls

Fujitsu Limited, Furukawa Sogo Bldg., 2-8 Marunouchi, Chiyoda-ku, Tokyo (Cable: Fujitsulimited); 680 Fifth Ave., New York, N.Y. 10019 (Tel: CO 5-5360)

Hokuyo Electric Industries Co., Ltd.

Katsuragawa Electric Co., Ltd. (voltage)

Nippon Electric Co., Ltd., 7-15 Shiba Gochome, Minato-ku, Tokyo (Cable:

Microphone); 200 Park Ave., New York, N.Y. 10017 (Tel: MO 1-3420); 80 rue de Namur, Bruxelles 1, Belgique (Tel: 12-74-61)

Ohkura Electric Co., Ltd. (controllers)

Sansui Electric Co., Ltd., 460 Izumi-cho, Suginami-ku, Tokyo (Cable: Sansui-elec) (voltage)

Tokyo Seimitsu Co., Ltd.

Tokyo Shibaura Electric Co., Ltd. (Toshiba), 1-1 Uchisaiwaicho, Chiyoda-ku, Tokyo (Cable: Toshiba); 530 Fifth Ave., New York, N.Y. 10036 (Tel: 587-5471); Berliner Allee 26, Duesseldorf 1, Germany (Tel: 29648-9)

Toritsu Tsushin Kogyo Co., Ltd., 5-20-8 Nishi-Gotanda, Shinagawa-ku, Tokyo (voltage)

Relays

Anritsu Electric Co., Ltd., 4-12-20 Minami-azabu, Minato-ku, Tokyo (Cable: Anritdenki)

Fujitsu Limited, Furukawa Sogo Bldg., 2-8 Marunouchi, Chiyoda-ku, Tokyo (Cable: Fujitsulimited); 680 Fifth Ave., New York, N.Y. 10019 (Tel: CO 5-5360)

Hasegawa Engineering Corp.

Matsushita Electric Industrial Co., Ltd., Electronic Components Div., Osaka; Matsushita Electric Corp. of America, 200 Park Ave., New York, N.Y. 10017 (Tel: 973-5710); Jungfernstieg 40, 2 Hamburg 36, Germany (Tel: 344743)

Nippon Electric Co., Ltd., 7-15 Shiba Gochome, Minato-ku, Tokyo (Cable: Microphone); 200 Park Ave., New York, N.Y. 10017 (Tel: MO 1-3420); 80 rue de Namur, Bruxelles 1, Belgique (Tel: 12-74-61)

Nippon Keidenki Mfg. Co., Ltd.

Oki Electric Industry Co., Ltd.

Sun Dengyosha Co., Ltd. (micro)

Takamisawa Electric Co., Ltd.

Tateisi Electronics Co., Ltd.

Tokyo Shibaura Electric Co., Ltd. (Toshiba), 1-1 Uchisaiwaicho, Chiyoda-ku, Tokyo (Cable: Toshiba); 530 Fifth Ave., New York, N.Y. 10036 (Tel: 587-5471); Berliner Allee 26, Duesseldorf 1, Germany (Tel: 29648-9)

Tsuda Electric Meters Co., Ltd.

Yaskawa Electric Mfg. Co., Ltd.

Resistors

Alps Electric Co., Ltd., 247 Yukigaya-cho, Tokyo (Cable: Alpsdenki); 1 Whitehall St., New York, N.Y. 10004

Asahi Ohm Co., Ltd. (carbon)

Copal Electronics Co., Ltd.

Fujitsu Limited

Japan Resistor Mfg. Co., Ltd.

Matsunaga International, Ltd.

Matsushita Electric Industrial Co., Ltd., Electronic Components Div., Osaka; Matsushita Electric Corp. of America, 200 Park Ave., New York, N.Y. 10017 (Tel: 973-5710); Jungfernstieg 40, 2 Hamburg 36, Germany (Tel: 344743)

Mitsumi Electric Co., Ltd., 1056 Koadachi, Komae-cho, Kitatama-gun, Tokyo (Cable: Mparts Tokyochofu); 11 Broadway, New York, N.Y. 10004 (Tel: HA 5-3085); Marienstrasse 12, Duesseldorf, Germany

Murata Mfg. Co., Ltd. (thermistors)

New Cosmos Electric Co., Ltd. (variable)

Nippon Electric Co., Ltd., 7-15 Shiba Gochome, Minato-ku, Tokyo (Cable: Microphone); 200 Park Ave., New York, N.Y. 10017 (Tel: MO 1-3420); 80 rue de Namur, Bruxelles 1, Belgique (Tel: 12-74-61)

Noblestat Co., Ltd. (variable)

Oizumi Mfg. Co., Ltd. (thermistors)

Oki Electric Industry Co., Ltd.

Shibaura Electronics Co., Ltd. (thermistors, varistors)

Susumu Industrial Co., Ltd., 6 Shonouchi-cho, Nakadoji, Shimokyo-ku, Kyoto (metal film modules)

TDK Electronics Co., Ltd., 2-14-6 Uchikanda, Chiyoda-ku, Tokyo (Cable: Tdkcore); 82 Wall St., New York, N.Y. 10005 (Tel: 425-7070) (thermistors, varistors)

Taiyo Denki Co., Ltd., 3-1-12 Sunamichi-cho, Sakai-city, Osaka (Cable: Solid-taiyohm) (solid fixed)

Teikoku Tsushin Kogyo Co., Ltd.

Tokyo Cosmos Electric Co., Ltd.

Toyo Communication Equipment Co., Ltd.

Toyo Electronics Industry Corp.

Yokogawa Electric Works, Ltd.

SILICON

"chisso"

Single crystal • Poly crystal

Reasonable Price. Stable Supply. /



Lapped wafer
Polished wafer
Epitaxial wafer



CHISSO CORP. SILICON DIVISION.

TOKYO BLDG. MARUNOUCHI 2-CHOME, CHIYODA-KU,
TOKYO, JAPAN

TELEPHONE: TOKYO (231) 4571 (Rep.) CABLE: CHISSO TOKYO TELEX: TK 2554 CHISSO

Semiconductors and Semiconductor Materials

Chisso Corp., Silicon Div., Tokyo Bldg., Marunouchi 2-chome, Chiyoda-ku, Tokyo (Cable: Chisso) (silicon)

Fujitsu Limited, Furukawa Sogo Bldg., 2-8 Marunouchi, Chiyoda-ku, Tokyo (Cable: Fujitsulimited); 680 Fifth Ave., New York, N.Y. 10019 (Tel: CO 5-5360)

Hitachi, Ltd.

Kobe Industries Corp.

Komatsu Electronic Metals Co., Ltd.

Kyodo Electronic Laboratories, Inc.

Mitsumi Electric Co., Ltd., 1056 Koadachi, Komae-cho, Kitatama-gun, Tokyo (Cable: Mparts Tokyochofu); 11 Broadway, New York, N.Y. 10004 (Tel: HA 5-3085); Marienstrasse 12, Duesseldorf, Germany (CdS)

Mori Physics & Chemistry Laboratory Co., Ltd. (CdS)

Nippon Electric Co., Ltd., 7-15 Shiba Gochome, Minato-ku, Tokyo (Cable: Microphone); 200 Park Ave., New York, N.Y. 10017 (Tel: MO 1-3420); 80 rue de Namur, Bruxelles 1, Belgique (Tel: 12-74-61)

Oizumi Mfg. Co., Ltd.

Oki Electric Industry Co., Ltd.

Primo Company, Ltd.

Shindengen Electric Mfg. Co., Ltd.

Sony Corp.

Taiyo Electronics Corp., 6-5-1 Togoshi, Shinagawa-ku, Tokyo (Cable: Apollo-hagita) (CdS)

Tokyo Shibaura Electric Co., Ltd. (Toshiba), 1-1 Uchisaiwaicho, Chiyoda-ku, Tokyo (Cable: Toshiba); 530 Fifth Ave., New York, N.Y. 10036 (Tel: 587-5471); Berliner Allee 26, Duesseldorf 1, Germany (Tel: 29648-9)

Servomechanisms

Fujitsu Limited, Furukawa Sogo Bldg., 2-8 Marunouchi, Chiyoda-ku, Tokyo (Cable: Fujitsulimited); 680 Fifth Ave., New York, N.Y. 10019 (Tel: CO 5-5360)

Signal Generators

Anritsu Electric Co., Ltd., 4-12-20 Minami-azabu, Minato-ku, Tokyo (Cable: Anritdenki)

Ikegami Tsushinki Co., Ltd.

Meguro Denpa Sokki Co., Ltd.

Nippon Electric Co., Ltd., 7-15 Shiba Gochome, Minato-ku, Tokyo (Cable: Microphone); 200 Park Ave., New York, N.Y. 10017 (Tel: MO 1-3420); 80 rue de Namur, Bruxelles 1, Belgique (Tel: 12-74-61)

TDK Electronics Co., Ltd., 2-14-6 Uchi-Kanda, Chiyoda-ku, Tokyo (Cable: Tdkcore); 82 Wall St., New York, N.Y. 10005 (Tel: 425-7070)

Sockets

Fujitsu Limited

Hoshiden Electronics Co., Ltd.

Mitsumi Electric Co., Ltd., 1056 Koa-

dachi, Komae-cho, Kitatama-gun, Tokyo (Cable: Mparts Tokyochofu); 11 Broadway, New York, N.Y. 10004 (Tel: HA 5-3085); Marienstrasse 12, Duesseldorf, Germany)

Showa Musen Kogyo Co., Ltd., 6-5-5 Togoshi, Shinagawa-ku, Tokyo (Cable: Showamusen)

Sound Systems and Speakers

Foster Electric Co., Ltd., 512 Miyazawamachi, Akishima-city, Tokyo (Cable: Foster Akishima); 230 N. Michigan Ave., Chicago, Ill.

Hayakawa Electric Co., Ltd., Abeno-ku, Osaka (Cable: Labomet Osaka); Sharp Electronics Corp., 178 Commerce Rd., Carlstadt, N.J. (Tel: 201-933-4200); Hohe Bleichen 16, 2 Hamburg 36, Germany

Lux Corp.

Matsushita Electric Industrial Co., Ltd., Electronic Components Div., Osaka; Matsushita Electric Corp. of America, 200 Park Ave., New York, N.Y. 10017 (Tel: 973-5710); Jungfernstieg 40, 2 Hamburg 36, Germany (Tel: 344743)

Nippon Electric Co., Ltd., 7-15 Shiba Gochome, Minato-ku, Tokyo (Cable: Microphone); 200 Park Ave., New York, N.Y. 10017 (Tel: MO 1-3420); 80 rue de Namur, Bruxelles 1, Belgique (Tel: 12-74-61)

Nippon Trumpet Trading Co., Ltd.

Osaka Onkyo Co., Ltd., 5-3 Ohmiya Nishinocho, Asahi-ku, Osaka (Cable: Onkyo Osaka); JEG, Stegstrasse 34, 6000 Frankfurt/M., Germany (Tel: 61-35-95)

Pioneer Electronic Corp., 4-15-5 Nishi Ohmori, Ohta-ku, Tokyo (Cable: Pioneer); 140 Smith St., Farmingdale, N.Y. 11735 (Tel: 516-694-7720); 50 Forch Strasse, 8032 Zurich, Switzerland (Tel: 477565)

Shinon Electric Co., Ltd.

Sonics Corp.

Sony Corp., 351 Kitashinagawa-6, Shinagawa-ku, Tokyo (Cable: Sonycorp)

Toa Electric Co., Ltd.

Tokyo Shibaura Electric Co., Ltd. (Toshiba), 1-1 Uchisaiwaicho, Chiyoda-ku, Tokyo (Cable: Toshiba); 530 Fifth Ave., New York, N.Y. 10036 (Tel:

587-5471); Berliner Allee 26, Duesseldorf 1, Germany (Tel: 29648-9)

Tonegen Electric Mfg. Co., Ltd.

Toyo Conepaper Co., Ltd.

Switches, Contacts, Switchgear, etc.

Alps Electric Co., Ltd., 247 Yukigaya-cho, Ohta-ku, Tokyo (Cable: Alpsdenki); 1 Whitehall St., New York, N.Y. 10004

Fujitsu Limited

Hoshiden Electronics Co., Ltd.

Iwasaki Communication Apparatus Co., Ltd., 2-710 Kugayama, Suginami-ku, Tokyo (Cable: Telephiwasaki)

Izumi Denki Co., Ltd.

Mitsumi Electric Co., Ltd., 1056 Koadachi, Komae-cho, Kitatama-gun, Tokyo (Cable: Mparts Tokyochofu); 11 Broadway, New York, N.Y. 10004 (Tel: HA 5-3085); Marienstrasse 12, Duesseldorf, Germany)

Nippon Electric Co., Ltd., 7-15 Shiba Gochome, Minato-ku, Tokyo (Cable: Microphone); 200 Park Ave., New York, N.Y. 10017 (Tel: MO 1-3420); 80 rue de Namur, Bruxelles 1, Belgique (Tel: 12-74-61)

Oizumi Mfg. Co., Ltd.

Oki Electric Industry Co., Ltd.

Sansei Electric Co., Ltd.

Showa Musen Kogyo Co., Ltd., 6-5-5 Togoshi, Shinagawa-ku, Tokyo (Cable: Showamusen)

Sun Dengyosha Co., Ltd. (micro)

Teikoku Tsushin Kogyo Co., Ltd.

Tokyo Shibaura Electric Co., Ltd., (Toshiba), 1-1 Uchisaiwaicho, Chiyoda-ku, Tokyo (Cable: Toshiba), 530 Fifth Ave., New York, N.Y. 10036 (Tel: 587-5471); Berliner Allee 26, Duesseldorf 1, Germany (Tel: 29648-9)

Toyo Musen Co., Ltd.

Yaskawa Electric Mfg. Co., Ltd.

Tape Recorders, VTR's, etc.

Akai Electric Co., Ltd.

Hayakawa Electric Co., Ltd., Abeno-ku, Osaka (Cable: Labomet Osaka); Sharp Electronics Corp., 178 Commerce Rd., Carlstadt, N.J. (Tel: 201-933-4200); Hohe Bleichen 16, 2 Hamburg 36, Germany

PIONEER®

for superlatively natural sound...PIONEER

Pioneer provides remarkably high fidelity in a wide range of audio products. Loudspeakers (their quality has made Pioneer the world's largest manufacturer of speakers... 1,500,000 units per month!). Record players, amplifiers, complete stereophonic systems, automobile stereo systems—all Pioneer equipment is designed to reproduce the sound of music as close to the original as possible. Listen to Pioneer and hear how amazingly close that is.

PIONEER ELECTRONIC CORPORATION
15, 5 Nishi 4-chome, Ohmori, Ohta-ku, Tokyo, Japan
Cable Address: PIONEER TOKYO

PIONEER ELECTRONICS U.S.A. CORPORATION
140 Smith Street, Farmingdale, N.Y. 11735, U.S.A. Phone: (516) 694-7720

*Write your name and address and return with this coupon to PIONEER TOKYO. We will send you a free brochure.



Hitachi, Ltd.

Ikegami Tsushinki Co., Ltd., 21 Motoki, Kawasaki-city (Cable: Iketsu Kawasaki); Ikegami Electronics Industries, Inc., 501 Fifth Ave., New York, N.Y. 10017 (Tel: 867-9209)

Matsushita Electric Industrial Co., Ltd.

Nippon Electric Co., Ltd., 7-15 Shiba Gochome, Minato-ku, Tokyo (Cable: Microphone); 200 Park Ave., New York, N.Y. 10017 (Tel: MO 1-3420); 80 rue de Namur, Bruxelles 1, Belgique (Tel: 12-74-61)

Oki Electric Industry Co., Ltd.

Sony Corp., 351 Kitashinagawa-6, Shinagawa-ku, Tokyo (Cable: Sonycorp)

Tokyo Shibaura Electric Co., Ltd. (Toshiba), 1-1 Uchisaiwaicho, Chiyoda-ku, Tokyo (Cable: Toshiba); 530 Fifth Ave., New York, N.Y. 10036 (Tel: 587-5471); Berliner Allee 26, Duesseldorf 1, Germany (Tel: 29648-9)

Telegraph, Telephone, Carrier and Facsimile Equipment

Anritsu Electric Co., Ltd., 4-12-20 Minami-Azabu, Minato-ku, Tokyo (Cable: Anritdenki)

Fujitsu Limited, Furukawa Sogo Bldg., 2-8 Marunouchi, Chiyoda-ku, Tokyo (Cable: Fujitsulimited); 680 Fifth Ave., New York, N.Y. 10019 (Tel: CO 5-5360) (Telegraph, telephone, carrier)

Hasegawa Engineering Corp.

Nippon Communication Industrial Co., Ltd., 260 Kitamikata, Kawasaki-city (Cable: Kawasaki Nicomm)

Nippon Electric Co., Ltd., 7-15 Shiba Gochome, Minato-ku, Tokyo (Cable: Microphone); 200 Park Ave., New York, N.Y. 10017 (Tel: MO 1-3420); 80 rue de Namur, Bruxelles 1, Belgique (Tel: 12-74-61)

Ohkura Electric Co., Ltd.

Oki Electric Industry Co., Ltd.

Shindengen Electric Mfg. Co., Ltd.

Tokyo Shibaura Electric Co., Ltd. (Toshiba), 1-1 Uchisaiwaicho, Chiyoda-ku, Tokyo (Cable: Toshiba); 530 Fifth Ave., New York, N.Y. 10036 (Tel: 587-5471); Berliner Allee 26, Duesseldorf 1, Germany (Tel: 29648-9)

Toyo Communication Equipment Co., Ltd., Toranomom Bldg., 15 Shiba-Toranomom, Minato-ku, Tokyo (Cable: Exportoyocom)

Television and Studio Equipment

Canon Camera Co., Inc.

Hayakawa Electric Co., Ltd., Abeno-ku Osaka (Cable: Labomet Osaka); Sharp Electronics Corp., 178 Commerce Rd., Carlstadt, N.J. (Tel: 201-933-4200); Hohe Bleichen 16, 2 Hamburg 36, Germany

Ikegami Tsushinki Co., Ltd., 21 Motoki, Kawasaki-city (Cable: Iketsu Kawasaki); Ikegami Electronics Industries, Inc., 501 Fifth Ave., New York, N.Y. 10017 (Tel: 867-9209)

Iwasaki Communication Apparatus Co., Ltd., 2-710 Kugayama, Suginami-ku, Tokyo (Cable: Telephiwasaki)

Kobe Industries Corp.

Kokusai Electric Co., Ltd., 9 Nishikubo-Sakuragawa-cho, Minato-ku, Tokyo (Cable: Sineshiba)

Nippon Electric Co., Ltd., 7-15 Shiba Gochome, Minato-ku, Tokyo (Cable: Microphone); 200 Park Ave., New York, N.Y. 10017 (Tel: MO 1-3420); 80 rue de Namur, Bruxelles 1, Belgique (Tel: 12-74-61)

Oki Electric Industry Co., Ltd.

Sony Corp., 351 Kitashinagawa-6, Shinagawa-ku, Tokyo (Cable: Sonycorp)

Tokyo Shibaura Electric Co., Ltd. (Toshiba), 1-1 Uchisaiwaicho, Chiyoda-ku, Tokyo (Cable: Toshiba); 530 Fifth Ave., New York, N.Y. 10036 (Tel: 587-5471); Berliner Allee 26, Duesseldorf 1, Germany (Tel: 29648-9)

Toritsu Tsushin Kogyo Co., Ltd., 5-20-8 Nishi-Gotanda, Shinagawa-ku, Tokyo (frequency multiplier)

Temperature and Cooling Devices

Ohkura Electric Co., Ltd. (controllers)

Tateisi Electronics Co., Ltd.

Tokyo Shibaura Electric Co., Ltd. (Toshiba), 1-1 Uchisaiwaicho, Chiyoda-ku, Tokyo (Cable: Toshiba); 530 Fifth Ave., New York, N.Y. 10036 (Tel: 587-5471); Berliner Allee 26, Duesseldorf 1, Germany (Tel: 29648-9)

Test Equipment and Testers (Electrical)

Musashi Electrical Instrument Works, Ltd.

Ohkura Electric Co., Ltd.

Tokyo Seimitsu Co., Ltd.

Tokyo Shibaura Electric Co., Ltd., (Toshiba), 1-1 Uchisaiwaicho, Chiyoda-ku, Tokyo (Cable: Toshiba); 530 Fifth Ave., New York, N.Y. 10036 (Tel: 587-5471); Berliner Allee 26, Duesseldorf 1, Germany (Tel: 29648-9)

Yokogawa Electric Works, Ltd.

Test Equipment and Testers (Electronic)

Anritsu Electric Co., Ltd., 4-12-20 Minami-Azabu, Minato-ku, Tokyo (Cable: Anritdenki)

Horiba Instruments, Inc.

Ikegami Tsushinki Co., Ltd.

Iwasaki Communication Apparatus Co., Ltd., 2-710 Kugayama, Suginami-ku, Tokyo (Cable: Telephiwasaki)

Japan Electronic Instrument Co., Ltd. (sound level)

Meguro Denpa Sokki Co., Ltd.

Metronix Corp.

Nikkyo Electronics Industry Co., Ltd.

Ohkura Electric Co., Ltd.

Oki Electric Industry Co., Ltd.

Ono Measuring Instrument Co., Ltd.

Sansei Electronics Corp.

Seiden Seisakusho Co., Ltd. (insulating)

TDS Electronics Co., Ltd., Apond Bldg., 1-7-12 Soto-Kanda, Chiyoda-ku, Tokyo (Cable: Tdselectronics)

Tabai Seisakusho Co., Ltd.

Takeda Riken Industry Co., Ltd., 285 Asahi-cho, Nerima-ku, Tokyo (Cable: Tritronics)

Tokyo Denpa Co., Ltd. (Tokyo Electric Wave), 5-6-11 Chuo, Ohta-ku, Tokyo (Cable: Tewdenpa)

Tokyo Seimitsu Co., Ltd.

Tokyo Shibaura Electric Co., Ltd. (Toshiba), 1-1 Uchisaiwaicho, Chiyoda-ku, Tokyo (Cable: Toshiba); 530 Fifth Ave., New York, N.Y. 10036 (Tel: 587-5471); Berliner Allee 26, Duesseldorf 1, Germany (Tel: 29648-9)

Yanagimoto Mfg. Co., Ltd.

Yokogawa Electric Works, Ltd.

Timers and Clocks

Hokuyo Electric Industries Co., Ltd.

Kokusai Electric Co., Ltd., 9 Nishikubo-Sakuragawa-cho, Minato-ku, Tokyo (Cable: Sineshiba)

Matsushita Electric Industrial Co., Ltd., Electronic Components Div., Osaka; Matsushita Electric Corp. of America, 200 Park Ave., New York, N.Y. 10017 (Tel: 973-5710); Jungfernstieg 40, 2 Hamburg 36, Germany (Tel: 344743)

Nippon Electric Co., Ltd., 7-15 Shiba Gochome, Minato-ku, Tokyo (Cable: Microphone); 200 Park Ave., New York, N.Y. 10017 (Tel: MO 1-3420); 80 rue de Namur, Bruxelles 1, Belgique (Tel: 12-74-61)

Oki Electric Industry Co., Ltd.

Tateisi Electronics Co., Ltd.

Tokyo Shibaura Electric Co., Ltd. (Toshiba), 1-1 Uchisaiwaicho, Chiyoda-ku, Tokyo (Cable: Toshiba); 530 Fifth Ave., New York, N.Y. 10036 (Tel: 587-5471); Berliner Allee 26, Duesseldorf 1, Germany (Tel: 29648-9)

Toyo Communication Equipment Co., Ltd., Toranomom Bldg., 15 Shiba-Toranomom, Minato-ku, Tokyo (Cable: Exportoyocom)

Transceivers and Mobile Communications Equipment

Anritsu Electric Co., Ltd., 4-12-20 Minami-Azabu, Minato-ku, Tokyo (Cable: Anritdenki)

Chiyoda Electronic Co., Ltd.

Fujitsu Limited, Furukawa Sogo Bldg., 2-8 Marunouchi, Chiyoda-ku, Tokyo (Cable: Fujitsulimited); 680 Fifth Ave., New York, N.Y. 10019 (Tel: CO 5-5360)

Hayakawa Electric Co., Ltd., Abeno-ku, Osaka (Cable: Labomet Osaka); Sharp Electronics Corp., 178 Commerce Rd., Carlstadt, N.J. (Tel: 201-933-4200); Hohe Bleichen 16, 2 Hamburg 36, Germany

Hitachi, Ltd.

Kobe Industries Corp.

Kokusai Electric Co., Ltd., 9 Nishikubo-Sakuragawa-cho, Minato-ku, Tokyo (Cable: Sineshiba)

FOR PHYSICAL ANALYSIS OF MATERIALS

TOSHIBA presents the new "DIFFPET" Model ADG-301 X-Ray Diffractometer

Compact but complete

DIFFPET is fully equipped with everything needed in a recording X-ray diffractometer. Its expansive table provides space for large cameras, while four different observations can be made simultaneously. Yet its compact design reduces necessary floor space to the barest minimum.

Extremely versatile, easy to operate

Up to two goniometers can be used or substituted by four cameras. Outside X-ray tube can be operated by high-tension cable, as when goniometer Model GD-1 is used. No special skill is needed when installed in manufacturer or research laboratory.

"DIFFPET" Model ADG-301 Components

X-RAY GENERATOR 50 kVp 40 mA continuous rating with voltage stabilizer, current stabilizer, X-ray and interlocked circuit safety cooling system.

GONIMETER Attached to X-ray tube housing. Scanning radius, 180mm; Angle 0-165° (2θ); Scanning speeds, 2°, 1° and ½° per minute. Number of slits 4. Sensitivity and resolution adjustable. Divergence angles, 1°, 2°; Incidence widths 0.15mm, 0.3mm
Detector: Toshiba Halogen GM Tube with Head Amplifier.

Rate Meter Sensitivity: selector: 100, 200, 500, 1,000, 2,000, cps Time Constant: 1, 2, 4, seconds Calibration signal provided.

Recorder 150mm with angle mark.



Tokyo Shibaura Electric Co., Ltd.

Producer Goods Export Division, Uchisaiwaicho, Tokyo, Japan

Agents wanted.



For IR Applications!

HTV's IR VIDICON TUBES

For use in infrared CCTV systems; Spectral response covers 400 to 2400 mμ; 500-TV lines resolution; Heater power is 0.95 watt.

N156=1 inch dia., 6 inches long

N157=1 inch dia., 5 inches long

PHOTOMULTIPLIER TUBES

Side-On Type=1P21, R106, R136, R212, R166, R196 and others
 Head-On Type=R189, R207, 6199, R192, 7102, 7696 and others



PHOTON IS OUR BUSINESS



HAMAMATSU TV CO., LTD.

Head Office: 456, EBITSUKA-CHO, HAMAMATSU-CITY, JAPAN Telex: 4225-185 JAPAN

East Coast: KINSHO-MATAICHI CORP. = 80 PINE STREET, NEW YORK 5, N.Y., U.S.A. Phone: Digby 4-6226

West Coast: CALIFORNIA EASTERN LABO., INC. = 801 MAHLER ROAD, BURLINGAME, CALIF., U.S.A. Phone: 697-6670

Nippon Electric Co., Ltd., 7-15 Shiba Gochome, Minato-ku, Tokyo (Cable: Microphone); 200 Park Ave., New York, N.Y. 10017 (Tel: MO 1-3420); 80 rue de Namur, Bruxelles 1, Belgique (Tel: 12-74-61)

Nissin Electronics Co., Ltd.

Oki Electric Industry Co., Ltd.

Osaka Onkyo Co., Ltd., 5-3 Ohmiya Nishinocho, Asahi-ku Osaka (Cable: Onkyo Osaka); JEG, Stegstrasse 34, 6000 Frankfurt, Germany (Tel: 61-35-95)

Sony Corp., 351 Kitashinagawa-6, Shinagawa-ku, Tokyo (Cable: Sonycorp)

Telecon Corp.

Tensho Electric Industries Co., Ltd.

Tokai Communication Apparatus Corp.

Tokyo Shibaura Electric Co., Ltd. (Toshiba), 1-1 Uchisaiwaicho, Chiyoda-ku, Tokyo (Cable: Toshiba); 530 Fifth Ave., New York, N.Y. 10036 (Tel: 587-5471); Berliner Allee 26, Duesseldorf 1, Germany (Tel: 29648-9)

Transducers

Matsushita Electric Industrial Co., Ltd., Electronic Components Div., Osaka; Matsushita Electric Corp. of America, 200 Park Ave., New York, N.Y. 10017 (Tel: 973-5710); Jungfernstieg 40, 2 Hamburg 36, Germany (Tel: 344743)

Murata Mfg. Co., Ltd.

Nippon Coil Co., Ltd.

Nippon Electric Co., Ltd., 7-15 Shiba Gochome, Minato-ku, Tokyo (Cable: Microphone); 200 Park Ave., New York, N.Y. 10017 (Tel: MO 1-3420); 80 rue de Namur, Bruxelles 1, Belgique (Tel: 12-74-61)

Oki Electric Industry Co., Ltd.

Tokyo Shibaura Electric Co., Ltd. (Toshiba), 1-1 Uchisaiwaicho, Chiyoda-ku, Tokyo (Cable: Toshiba); 530 Fifth Ave., New York, N.Y. 10036 (Tel: 587-5471); Berliner Allee 26, Duesseldorf 1, Germany (Tel: 29648-9)

Yokogawa Electric Works, Ltd.

Transformers

Hitachi, Ltd.

Ikegami Tsushinki Co., Ltd.

Lux Corp. (including output)

Matsunaga International, Ltd.

Matsushita Electric Industrial Co., Ltd., Electronic Components Div., Osaka; Matsushita Electric Corp. of America, 200 Park Ave., New York, N.Y. 10017 (Tel: 973-5710); Jungfernstieg 40, 2 Hamburg 36, Germany (Tel: 344743)

Sansui Electric Co., Ltd., 460 Izumicho, Suginami-ku, Tokyo (Cable: Sansuielec)

Seiden Seisakusho Co., Ltd.

Shinon Electric Co., Ltd. (output)

TDK Electronics Co., Ltd., 2-14-6 Uchi-Kanda, Chiyoda-ku, Tokyo (Cable: Tdkcore); 82 Wall St., New York, N.Y. 10005 (Tel: 425-7070)

Tabuchi Electric Co., Ltd.

Tamura Seisakusho, Ltd., 433 Higashi-Oizumi-machi, Nerima-ku, Tokyo (Cable: Nipontamradio); Tamradio Co., Ltd., 501 Larree Bldg., 5817 N. Kenmore Ave., Chicago, Ill. 60626 (Tel: 312-561-3842) (miniature and milspec)

Tohoku Metal Industries, Ltd., 7-4 Ginza-Higashi, Chuo-ku, Tokyo (Cable: Tohokumetal)

Tokyo Shibaura Electric Co., Ltd. (Toshiba), 1-1 Uchisaiwaicho, Chiyoda-ku, Tokyo (Cable: Toshiba); 530 Fifth Ave., New York, N.Y. 10036 (Tel: 587-5471); Berliner Allee 26, Duesseldorf 1, Germany (Tel: 29648-9)

Tongen Electric Mfg. Co., Ltd. (output)
Toritsu Tsushin Kogyo Co., Ltd., 5-20-8 Nishi-Gotanda, Shinagawa-ku, Tokyo

Tsuda Electric Meters Co., Ltd.
Yokogawa Electric Works, Ltd.
Youth Electric Co., Ltd.

Transformers, IF

Hokuyo Musen Kogyo Co., Ltd.

Mitsumi Electric Co., Ltd., 1056 Koadachi, Komae-cho, Kitatama-gun, Tokyo (Cable: Mparts Tokyochofu); 11 Broadway, New York, N.Y. 10004 (Tel: HA 5-3085); Marienstrasse 12, Duesseldorf, Germany

Toko, Inc.

Tubes

Hamamatsu TV Co., Ltd., 456 Ebisuka-

cho, Hamamatsu-city (Cable: Hamatv Hamamatsu); 80 Pine St., New York, N.Y. 10005

Kobe Industries Corp.

Nippon Electric Co., Ltd., 7-15 Shiba Gochome, Minato-ku, Tokyo (Cable: Microphone); 200 Park Ave., New York, N.Y. 10017 (Tel: MO 1-3420); 80 rue de Namur, Bruxelles 1, Belgique (Tel: 12-74-61)

Taiyo Electronics Corp., 6-5-1 Togoshi, Shinagawa-ku, Tokyo (Cable: Apolohagita)

Tokyo Shibaura Electric Co., Ltd. (Toshiba), 1-1 Uchisaiwaicho, Chiyoda-ku, Tokyo (Cable: Toshiba); 530 Fifth Ave., New York, N.Y. 10036 (Tel: 587-5471); Berliner Allee 26, Duesseldorf 1, Germany (Tel: 29648-9)

Toyo Musen Co., Ltd., 1-8-10 Wakabayashi, Setagaya-ku, Tokyo (Cable: Toyoradicator); 938 Merchandise Mart, Chicago, Ill., 60654

Yaskawa Electric Mfg. Co., Ltd.

Tuners

Alps Electric Co., Ltd., 247 Yukigaya-cho, Ohta-ku, Tokyo (Cable: Alpsdenki); 1 Whitehall St., New York, N.Y. 10004

Fujitsu Limited

Hayakawa Electric Co., Ltd., Abeno-ku, Osaka (Cable: Labomet Osaka); Sharp Electronics Corp., 178 Commerce Rd., Carlstadt, N.J. (Tel: 201-

933-4200); Hohe Bleichen 16, 2 Hamburg 36, Germany

Mitsumi Electric Co., Ltd., 1056 Koadachi, Komae-cho, Kitatama-gun, Tokyo (Cable: Mparts Tokyochofu); 11 Broadway, New York, N.Y. 10004 (Tel: HA 5-3085); Marienstrasse 12, Duesseldorf, Germany

Nippon Electric Co., Ltd., 7-15 Shiba Gochome, Minato-ku, Tokyo (Cable: Microphone); 200 Park Ave., New York, N.Y. 10017 (Tel: MO 1-3420); 80 rue de Namur, Bruxelles 1, Belgique (Tel: 12-74-61)

San Esu Electronics Co., Ltd.

Sansui Electric Co., Ltd., 460 Izumicho, Suginami-ku, Tokyo (Cable: Sansuielec)

Ultrasonic Equipment

Hayakawa Electric Co., Ltd., Abeno-ku, Osaka (Cable: Labomet Osaka); Sharp Electronics Corp., 178 Commerce Rd., Carlstadt, N.J. (Tel: 201-933-4200); Hohe Bleichen 16, 2 Hamburg 36, Germany

Kobe Industries Corp.

Kokusai Electric Co., Ltd., 9 Nishikubo-Sakaragawa-cho, Minato-ku, Tokyo (Cable: Sineshiba)

Matsushita Electric Industrial Co., Ltd., Electronic Components Div., Osaka; Matsushita Electric Corp. of America, 200 Park Ave., New York, N. Y. 10017

**We manufacture —
All types of trans-
formers —
You name it and we make them!**

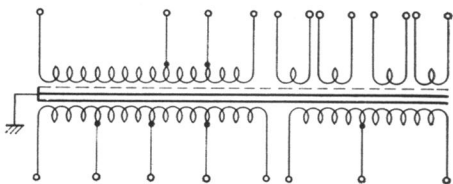

Tamura are the specialists in the manufacture of custom made transformers. Please feel free to send your inquiry and specifications to either Tamura's Foreign Department or TAMRADIO. Immediate and attentive responses are ensured at all times.

We are especially experienced in the field of such compact transformers as in use for small pulser, delay line, communication, broadcasting, MIL standards, measuring, sound reproduction, radio and television etc.

TAMURA SEISAKUSHO CO., LTD.

Head Office: 433 Higashi-Oizumi-machi, Nerima-ku, Tokyo
Cable: NIPONTAMRADIO Telex: 0-272-2201 TAMRADIO TOK
Foreign Department: Nichibi Bldg., 1-10-1 Nishi-Shinbashi, Minato-ku, Tokyo
Cable: SHINTAMRADIO Telex: 0-222-3449 TAMRADIO TOK

TAMRADIO COMPANY, LTD.

U.S.A.: #501 Larree Bldg., 5817 N. Kenmore Ave., Chicago, Ill. 60626
Tel: 312-561-3842 Telex: 253021 TAMRADIO CGO

Applications Galore! Alps Technology Means "Userbility"!



Alps VHF and UHF tuners are geared for unlimited applications— all-channel television, color television, and more ...

Where next ?

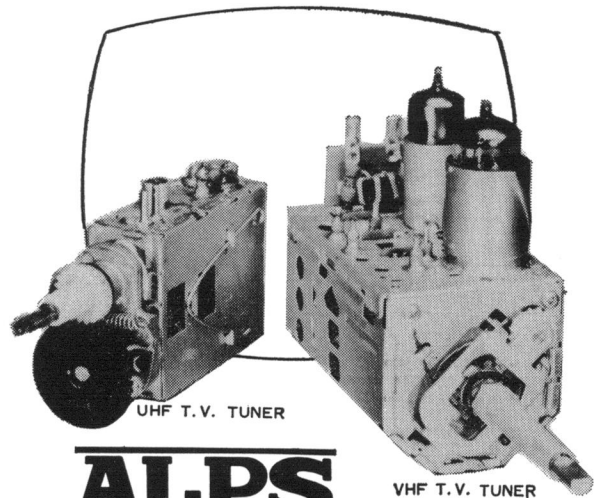

ALPS



ALPS ELECTRIC CO., LTD.

HEAD OFFICE: 2C, 318-3A-10, OHTA-KU, TOKYO, JAPAN
YOKOHAMA FACTORY: 1-10, NIPPON-CHO, KOHNO-KU, YOKOHAMA, JAPAN
OSAKA BRANCH: 2-1-1, NISHI-KU, SHINJUKU-KU, OSAKA, JAPAN
NEW YORK OFFICE: 604, WHITEHALL ST., NEW YORK, N. Y., U.S.A.

(Tel: 973-5710); Jungfernstieg 40, 2 Hamburg 36, Germany (Tel: 344743)
 Nippon Electric Co., Ltd., 7-15 Shiba-Gochome, Minato-ku, Tokyo (Cable: Microphone); 200 Park Ave., New York, N.Y. 10017 (Tel: MO 1-3420); 80 rue de Namur, Bruxelles 1, Belgique (Tel: 12-74-61)
 Oki Electric Industry Co., Ltd.
 Shindengen Electric Mfg. Co., Ltd.
 Tamura Seisakusho, Ltd.
 Teikoku Tsushin Kogyo Co., Ltd.
 Tokai Communication Apparatus Corp.

Vacuum Equipment and Components

Hitachi, Ltd.
 Japan Vacuum Engineering Co., Ltd.
 Kobe Industries Corp.
 Neo Ark Science & Technology, Inc., 1-23 Wakamatsu-cho, Fuchu-city, Tokyo (Cable: Neoark Fuchu)
 Nippon Electric Co., Ltd., 7-15 Shiba-Gochome, Minato-ku, Tokyo (Cable: Microphone); 200 Park Ave., New York, N.Y. 10017 (Tel: MO 1-3420); 80 rue de Namur, Bruxelles 1, Belgique (Tel: 12-74-61)
 Shinko Seiki Co., Ltd.
 Taiyo Electronics Corp., 6-5-1 Togoshi, Shinagawa-ku, Tokyo (Cable: Apollo-hagita)
 Tokyo Vacuum Machinery Co., Ltd.
 Toyo Communication Equipment Co., Ltd., Toranomon Bldg., 15 Shiba-Toranomon, Minato-ku, Tokyo (Cable: Exportoyocom)
 Yaskawa Electric Mfg. Co., Ltd.

SERVICES

Airlines Serving Japan

Trans-Pacific: BOAC, Japan Air Lines, Northwest Airlines, Pan American Airways, Canadian-Pacific Airways
Europe-Japan: Air France, Alitalia, BOAC, Japan Air Lines, KLM-Royal Dutch Airlines, Lufthansa-German Airlines, Pan American Airways, Scandinavian Airlines (SAS), Swissair

Associations

Electronic Industries Association of Japan (EIA-J), Tokyo Chamber of Commerce Bldg., 3-14 Marunouchi, Chiyoda-ku, Tokyo (Cable: Elindaso); 437 Fifth Ave., New York, N. Y. 10016 (Tel: MU 6-0731); Berliner Allee 32, Dueseldorf, Germany (Tel: 12351-3)
Japan Electric Measuring Instruments Mfrs. Association (JEMIMA), 20 Shiba Kotohira-cho, Minato-ku, Tokyo

Banks and Financial Institutions Serving Japan

American Express Co., Bank of America, Chase-Manhattan Bank, Continental Bank, First National City Bank
 Tokai Bank, Ltd., Naka-ku, Nagoya (Cable: Tokaibank Nagoya); 1-5-1 Tori-Nihombashi, Chuo-ku, Tokyo (Cable: Tokaibank Tokyo); 67 Broad St., New York, N. Y. 10004; Plantation House, Mincing Lane, London E.C. 3

Engineering, Technical Cooperation, R-D Services

Japan Vacuum Engineering Co., Ltd., 1-1 Kyobashi, Chuo-ku, Tokyo (Cable: Vactec)

Export-Import & Marketing Services

East/West Marketing Associates, Inc., Kuratomo Bldg., 1-12 Kanda-Nishiki-cho, Chiyoda-ku, Tokyo (Cable: East-westmktg)
 Funai Electric Co., Ltd., 3-20 Naka-Ikaino, Ikuno-ku, Osaka; 3004 W. Logan Blvd., Chicago, Ill. 60647
 Sansei Electronics Corp., Kinsan Bldg., 4-5 Nihombashi-Muromachi, Chuo-ku, Tokyo (Cable: Artnas)
Tsurumi Trading Co., Ltd., 1-2-4 Komagata, Daito-ku, Tokyo (Cable: Tsurimico)

Publishing

Dempa Publications, Inc., 1-129-1 Gotanda, Shinagawa-ku, Tokyo (Cable: Dempashinbun)
 Institute of Electrical Engineers of Japan, 1-3 Yuraku-cho, Chiyoda-ku, Tokyo
 Institute of Electrical Communications Engineers of Japan, 21-1-5 Shiba Koen, Minato-ku, Tokyo
 Institute of TV Engineers of Japan, Kikai Shinko Bldg., 21 Shiba Koen, Minato-ku, Tokyo
 Nikkan Kogyo Shimibun (Industrial Daily News, Ltd.), 1-8-10 Kudankita, Chiyoda-ku, Tokyo
 Radio Shyogyo Shinbun, Inc. (Japan Overseas Publication, Inc.), Chiyoda 1st Bldg., 1-27 Kanda Nishikicho, Chiyoda-ku, Tokyo

A listing of exhibitors at the annual Japan Electronics show begins on page 173.

READER SERVICE COUPON

To obtain additional information on any of the products advertised in this Directory of Japanese manufacturers, or in the section on the Japan Electronics Show which begins on page 173, complete the coupon below, showing the product in which you are interested, and mail to IEEE, Tokyo Advertising Office, Kuratomo Building, 1-12 Kanda Nishiki-cho, Chiyoda-ku, Tokyo, Japan.

Name _____
 Title _____
 Company _____
 Address _____
 City _____ State _____ Zip _____

August 1967
 IEEE Spectrum



Product	Name of Manufacturer	Page No.

ALPHABETICAL INDEX

(Bold-faced listings indicate firm has an advertisement in this issue or is a regular IEEE advertiser.)

Akai Electric Co., Ltd., 2-1-21-4 Higashi-Kojiya, Ohta-ku, Tokyo (Hifakai); 5922 Boweroft St., Los Angeles, Calif. 90016 (870-9631)

Akiyoshi Electric Co., Ltd., 2-12-5 Naka-Ikegami, Ohta-ku, Tokyo

Alps Electric Co., Ltd., 247 Yukigaya-cho, Ohta-ku, Tokyo (Alpsdenki); 1 Whitehall St., New York, N.Y. 10004

Anritsu Electric Co., Ltd., 4-12-20 Minami-Azabu, Minato-ku, Tokyo (Anritdenki)

Aoba Seiki Seisakusho Co., Ltd., 6-2652 Ohmori, Ohta-ku, Tokyo

Asahi Ohm Co., Ltd., 4-22 Sakuma-cho, Kanda, Chiyoda-ku, Tokyo (Asahiresistor)

Canon Camera Co., Inc., 5-3 Ginza, Chuo-ku, Tokyo (Canon); 550 Fifth Ave., New York, N.Y. 10036; 1 rue de Hesse, Geneva, Switzerland

Casio Computer Co., Ltd., 229 Yamatomachi, Kitatama-gun, Tokyo (Higashimurayama); Gubelstrasse 32, CH8050 Zurich, Switzerland

Chisso Corp., Silicon Div., Tokyo Bldg., Marunouchi 2-chome, Chiyoda-ku, Tokyo (Chisso)

Chiyoda Electronic Co., Ltd., 3-3-9 Soto-Kanda, Chiyoda-ku, Tokyo (Nikkaexport)

Copal Electronics Co., Ltd., #5 Mori Bldg., 26 Sakuragawa-cho, Minato-ku, Tokyo

DX Antenna Co., Ltd., 5-6 Irie-dori, Hyogo-ku, Kobe (Dxantenna Kobe)

Dainippon Screen Mfg. Co., Ltd., Hori-kawa-dori, Kuramaguchi, Kamikyo-ku, Kyoto; 3801 S. Broadway, Los Angeles, Calif. 90037

Foster Electric Co., Ltd., 512 Miyazawamachi, Akishima-city, Tokyo (Foster Akishima); 230 N. Michigan Ave., Chicago, Ill.

Fox Electronics Co., Ltd., 5-32-8 Kamata, Ohta-ku, Tokyo (Foxdenshi); JEG, Stegstrasse 34, 6000 Frankfurt/M., Germany (61-35-95)

Fuji Electrochemical Co., Ltd., Hamagomu Bldg., 5-11-36 Shimbashi, Minato-ku, Tokyo (Noveldrycell); 537 Fifth Ave., New York, N.Y. 10016 (LE 2-5630); Neuerwall 34, Hamburg 36, Germany

Fujitsu Limited, Furukawa Sogo Bldg., 2-8 Marunouchi, Chiyoda-ku, Tokyo (Fujitsulimited); 680 Fifth Ave., New York, N.Y. 10019 (CO 5-5360)

Funai Electric Co., Ltd., 3-20 Nakakaino, Ikuno-ku, Osaka; 3004 Logan Blvd., Chicago, Ill. 60647

Furukawa Electric Co., Ltd., 2-8 Maru-

nouchi, Chiyoda-ku, Tokyo (Furueleco)

Hachiman Electronic Works, Ltd., Koshin Bldg., 3-373 Hyakunincho, Shinjuku-ku, Tokyo (Hachimanex)

Hamamatsu TV Co., Ltd., 456 Ebisuka-cho, Hamamatsu-city, Japan (Hamatv Hamamatsu); 80 Pine St., New York, N.Y. 10005

Hasegawa Engineering Corp., 1-20-20 Oyamadai, Shinagawa-ku, Tokyo

Hayakawa Electric Co., Ltd., Abeno-ku, Osaka (Labomet Osaka); Sharp Electronics Corp., 178 Commerce Road, Carlstadt, N.J. (201-933-4200); POB 54274 Terminal Annex, Los Angeles, Calif. (269-7288); Chicago (312-263-7217); Hohe Bleichen 16, 2 Hamburg 36, Germany

Hirai Denkeiki Co., Ltd., 37 Miyano Nishicho, Kichijoyoin-Nakagawara, Minami-ku, Kyoto

Hirose Electric Co., Ltd., 6-5 chome, Higashi-Osaki, Shinagawa-ku, Tokyo (Beseleconhiro)

Hitachi, Ltd., 1-4 Marunouchi, Chiyoda-ku, Tokyo (Hitachy); 666 Fifth Ave., New York, N.Y. 10019; Graf-Adolf-Strasse, 4 Duesseldorf, Germany

Hokuyo Electric Industries Co., Ltd., Kokudo Bldg., Umeda Shinmichi, Kita-ku, Osaka (Hokuyodenki Osaka)

Just feel this precise action
rotary switch, lever switch, slide switch

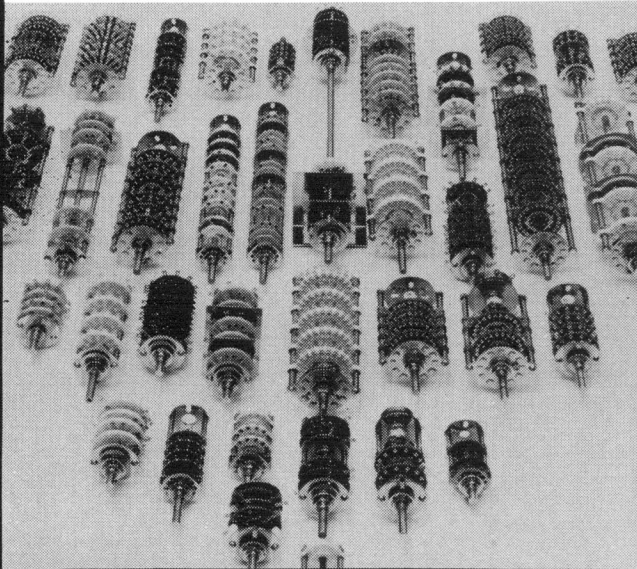

IWASAKI

COMMUNICATION APPARATUS CO., LTD.
710 2-chome, Suginami-ku, Tokyo, Japan
Cable: TELEPHIWASAKI Telex: TK-4225 TELEIWA

Voltan

Voltan (Ferro-Resonance Type Voltage Regulators)

- VN 33** Three phase output from three phase input
 - VN 31** Single phase output from three phase input
 - VN 13** Three phase output from single phase input
- Multif Voltan** (Magnetic Type Frequency Multipliers)
- MVN 31** Single phase output from three phase input
 - MVN 33** Three phase output from three phase input
 - MVN 11** Single phase output from single phase input
- Voltano Converter** (Phase Converter)
- VOC 13** Three phase output from single phase input

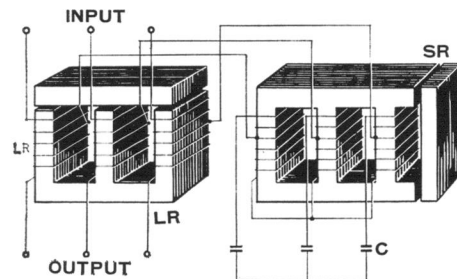

Circuit diagram of VN33

Main Features

- (a) Simple construction.
- (b) Low cost, compact and sturdy built.
- (c) Good waveform, well balancing.
- (d) Excellent stability, quick response.
- (e) High power factor, high efficiency.
- (f) Large output power.



TORITSU TSUSHIN KOGYO CO., LTD.

20-8, 5-chome, Nishigotanda, Shinagawa-ku, Tokyo, Japan
Phone: Tokyo 491-1191

Agency: **Maruka Machinery Co., Ltd.**

41 Bungo-machi, Higashi-ku, Osaka, Japan P.O. Box Higashi 350.

- Hokuyo Musen Kogyo Co., Ltd., 4-6 Shikishima-cho, Joto-ku, Osaka (Hokuyorising Osaka); JEG, Stegstrasse 34, 6000 Frankfurt/M., Germany (61-35-95)
- Horiba Instrument, Inc., Nakagawara-Miyano-Higashi, Kiichijyoin, Minami-ku, Kyoto
- Hoshiden Electronics Co., Ltd., 2120 Kyuhoji, Yao-city, Osaka (Hoshiden Yao); JEG, Stegstrasse 34, 6000 Frankfurt/M., Germany (61-35-95)
- Ichizuka Optical Co., Ltd., 2-568 Shimo-ochiai, Shinjuku-ku, Tokyo (Moviekino)
- Iizuka Electric Industry Co., Ltd., 1-20-6 Higashi-Ueno, Taito-ku, Tokyo
- Ikegami Tsushinki Co., Ltd., 21 Motoki, Kawasaki-city (Iketsu Kawasaki); Ikegami Electronics Industries, Inc., of N.Y., 501 Fifth Ave., New York, N.Y. 10017 (867-9209)
- Iwasaki Communication Apparatus Co., Ltd., 2-710 Kugayama, Suginami-ku, Tokyo (Telephiwasaki)
- Izumi Denki Co., Ltd., 2-17 Oimatsu-cho, Kita-ku, Osaka
- Japan Electronic Instrument Co., Ltd., 2-445 Naka-meguro, Meguro-ku, Tokyo
- Japan Resistor Mfg. Co., Ltd., 3-6-20 Minami-Oi, Shinagawa-ku, Tokyo (Japanresistor)
- Japan Vacuum Engineering Co., Ltd., 1-1 Kyobashi, Chuo-ku, Tokyo (Vactec)
- KCC Shokai, Ltd., 4-71 Kita-dori, Nada-ku, Kobe (Wmkcc Kobe); 35-60 74th, Jackson Heights, N.Y.
- KCK Co., Ltd., 5-16 Takinogawa, Kita-ku, Tokyo (Kawacera); 528 W. Wellington Ave., Chicago, Ill. 60657 (327-8392)
- Katsuragawa Electric Co., Ltd., 1-5-17 Yaguchi, Ohta-ku, Tokyo (Kazragawaden)
- Kinsekisha Laboratory, Ltd., 2-17-23 Miyasaka, Setagaya-ku, Tokyo (Crystal)
- Kobe Industries Corp., 2-8 Marunouchi, Tokyo (Kobeindustries); 5858 Hollywood Blvd., Los Angeles, Calif. 90054 (467-2445)
- Kokusai Electric Co., Ltd., 9 Nishikubo-Sakuragawa-cho, Minato-ku, Tokyo (Sineshiba)
- Komatsu Electronic Metals Co., Ltd., 2-3-6 Akasaka, Minato-ku, Tokyo (Komametal)
- Kyodo Electronic Laboratories, Inc., 5153 Kamitsuruma, Sagamihara-city (Kelic Machida)
- Kyoto Ceramic Co., Ltd., 11 Haramachi, Nishinokyo, Nakagyo-ku, Kyoto (Kyocera)
- Lux Corp., 2-22 Nagahashi-dori, Nishinari-ku, Osaka (Luxelect Osaka)
- Matsunaga International, Ltd., Kyowa Bldg., 34 Shiba Kotohiracho, Minato-ku, Tokyo (Matsunagaslide)
- Matsuo Electric Co., Ltd., 3-chome Sennari-cho, Toyonaka-city, Osaka (Nccmatsuo Osaka)
- Matsushita Electric Industrial Co., Ltd., Electronic Components Div., Kadoma, Osaka; Matsushita Electric Corp. of America, 200 Park Ave., New York, N.Y. 10017 (973-5710); Jungfernstieg 40, Hamburg 36, Germany (344743-45)
- Meguro Denpa Sokki Co., Ltd., 2-5-1 Chuo-cho, Meguro-ku, Tokyo (Megurodenpa)
- Metronix Corp., 76 Chofu-Chidori-cho, Ohta-ku, Tokyo (Metronixcorp)
- Midori Precisions Co., Ltd., 2-17-1 Kokuryo-machi, Chofu-city
- Mitaka Electrical Instrument Works, 4-14 Higashi-Ueno, Taito-ku, Tokyo (Mitakameter)
- Mitsumi Electric Co., Ltd., 1-56 Koadachi, Komae-cho, Kitatama-gun, Tokyo (Mparts Tokyochofu); 11 Broadway, New York, N.Y. 10004 (HA 5-3085); Marienstrasse 12, Duesseldorf, Germany
- Mitutoyo Mfg. Co., Ltd., 5-33-7 Shiba, Minato-ku, Tokyo; MTI Corp., 11 E. 26th St., New York, N.Y. 10010 (212-683-0860)
- Mori Physics & Chemistry Laboratory Co., Ltd., 2-5 Tozuka-machi, Tozuka-ku, Yokohama (Moririka Yokohama)
- Murata Mfg. Co., Ltd., Nagaoka-cho, Otokuni-gun, Kyoto (Murata Kyoto); 160 Broadway, New York, N.Y. 10038 (686-2510)
- Musashi Electrical Instruments Works, Ltd., 1-29-8 Nishikubo, Musashino-city
- NGK Spark Plug Co., Ltd., 1-17 Horitadori, Mizuho-ku, Nagoya (Plugngk Nagoya); 4010 Sawtelle Blvd., Los Angeles, Calif. 90066 (213-397-8184)
- Neo Ark Science & Technology, Inc., 1-23 Wakamatsu-cho, Fuchu-city, Tokyo (Neoark Fuchu)
- New Cosmos Electric Co., Ltd., 3-3 Mitsuya-Nakadori, Higashiyodogawa-ku, Osaka; Stegstrasse 34, 6000 Frankfurt/M., Germany (61-35-95)
- Nichicon Capacitor, Ltd., Oikedoru Karasumahigashi-iru, Nakagyo-ku, Kyoto (Capacitor Kyoto)
- Nichiwa Sangyo Co., 5-1 Itachibori-Minamidori, Nishi-ku, Osaka (Watoni Osaka)
- Nihon Steatite Industry Co., Ltd., Ohno Bldg., 70 Matsunaga-cho, Kanda, Chiyoda-ku, Tokyo
- Nikkoy Electronics Industry Co., Ltd., 14 Shimominamida-cho, Jyodoji, Sakyo-ku, Kyoto
- Nippon Blower Co., Ltd., 1-34 Minami-Tokiwadai, Itabashi-ku, Tokyo
- Nippon Chemical Condenser Co., Ltd., 2-7-8 Yutaka-cho, Shinagawa-ku, Tokyo; 1 Whitehall St., New York, N.Y. 10004 (HA 5-2700); Nyborgsgand 1, Hagersten, Sweden (08-195001)
- Nippon Coil Co., Ltd., Amakawa Bldg., 1-1 Hon-machi, Higashi-ku, Osaka
- Nippon Electric Co., Ltd., 7-15 Shiba Gochome, Minato-ku, Tokyo (Microphone); Pan Am Bldg., 200 Park Ave., New York, N.Y. 10017 (MO 1-3420); 80 rue de Namur, Bruxelles 1, Belgique (12-74-61)
- Nippon Ferrite Industrial Co., Ltd., 21 Ichigaya, Sanai-cho, Shinjuku-ku, Tokyo (Nippon Ferrite)
- Nippon Keidenki Mfg. Co., Ltd., 4-8-1 Ohmori-Kita, Ohta-ku, Tokyo
- Nippon Trumpet Trading Co., Ltd., 6-1 Fukae-Higashi, Higashinari-ku, Osaka (Sonopet Osaka)
- Nissei Electric Co., Ltd., 1-12 Ebisu-Minami, Shibuya-ku, Tokyo (Condensisei); 231 W. 25th St., New York, N.Y. 10001 (YU 9-9990)
- Nissin Electronics Co., Ltd., Toranomom Denki Bldg., 15 Shiba-Nishikubo Akefune-cho, Minato-ku, Tokyo (Nissin-electron)
- Nitsuko Ltd. (Nippon Communication Industrial Co., Ltd.), 260 Kitamikata, Kawasaki-city (Kawasaki Nicomm)
- Nitto Electric Industrial Co., Ltd., 27 Umeda-cho, Kita-ku, Osaka (Suneast Osaka); 501 Fifth Ave., New York, N.Y. 10017 (TN 7-3295)
- Nobelstat Co., Ltd., 105 Shinjo, Kawasaki-city
- Ogura Jewel Industries Co., Ltd., 5-12-7 Ohmori-Kita, Ohta-ku, Tokyo (Ogura-jewel)
- Ohkura Electric Co., Ltd., School Bldg., 1-11-16 Shibuya, Shibuya-ku, Tokyo (Electokra)
- Oizumi Mfg. Co., Ltd., 1-28-1 Nukui-cho, Nerima-ku, Tokyo
- Oki Electric Industry Co., Ltd., 1-Shiba Kotohira-cho, Minato-ku, Tokyo (Okidenki); 202 E. 44th St., New York, N.Y. 10017
- Omori Denki Seisakusho Co., Ltd., 2-15-15 Naka-Ikegami, Ohta-ku, Tokyo
- Ono Measuring Instrument Co., Ltd., 16-22-2 Shimo-Maruko, Ohta-ku, Tokyo
- Osaka Onkyo Co., Ltd., 5-32 Ohmiya Nishinocho, Asahi-ku, Osaka (Onkyo Osaka); JEG, Stegstrasse 34, 6000 Frankfurt/M., Germany (61-35-95)
- Osaka Titanium Co., Ltd., 3-6-10 Nishi-Shimbashi, Minato-ku, Tokyo
- Pioneer Electronic Corp., 4-15-5 Nishi Ohmori, Ohta-ku, Tokyo (Pioneer); 140 Smith St., Farmingdale, N.Y. 11735 (516-694-7720); 59 Forch Strasse, 8032 Zurich, Switzerland (477565)
- Primo Company, Ltd., 2043 Mure, Mitaka-city, Tokyo (Primo Musashino Mitaka); Suite 204, 530 W. Surf St., Chicago, Ill. 60657 (312-472-6142)
- Risho Kogyo Co., Ltd., 2-40 Dojima-Naka, Kita-ku, Osaka (Rishokogyo Osaka)
- San Esu Electronics Co., Ltd., 6-1-2 Nishi-Oi, Shinagawa-ku, Tokyo (Sanesaricon); JEG, Stegstrasse 34, 6 Frankfurt/M., Germany
- Sansei Electric Co., Ltd., 5-11-13 Ebara, Shinagawa-ku, Tokyo (Sanseiparts)
- Sansei Electronics Corp., Kinsan Bldg., 4-5 Nihombashi Muromachi, Chuo-ku, Tokyo (Artnas)
- Sansha Electric Trading Co., Ltd., P.O. Box Central 946, Osaka (Elemacine Osaka)
- Sansui Electric Co., Ltd., 460 Izumi-cho, Suginami-ku, Tokyo (Sansuielec)
- Sanwa Print Seisakusho Co., Ltd., 522 Koyama-machi, Matsudo-city, Chiba-prefecture
- Seiden Seisakusho Co., Ltd., 3-1-22 Hiratsuka, Shinagawa-ku, Tokyo
- Settsu Metal Industrial Co., Ltd., 2-173 Nishimachi, Moriguchi-city, Osaka (Ideal Moriguchi)
- Shiba Electric Co., Ltd., 2-20 Uchisaiwai-cho, Chiyoda-ku, Tokyo (Elecshiba); 58-25 Brooklyn-Queens Expressway, Woodside, N.Y. 11377 (898-1261)
- Shibaura Electronics Co., Ltd., 520 Machiya, Urawa-city, Saitama-prefecture (Electroshibaura)
- Shin-Ei Industrial Co., Ltd., 4-9-7 Meguro-Honcho, Meguro-ku, Tokyo
- Shindengen Electric Mfg. Co., Ltd., 2-4 Ohtemachi, Chiyoda-ku, Tokyo (Shindengen)
- Shinko Seiki Co., Ltd., 4-2 Karumo-Dori, Nagata-ku, Kobe (Nagatashinko Kobe)

foster® firsts

foster announces manufacturing facilities now in full operation on four new magnetic heads—including stereo heads for cassette recorders and 8-track stereo heads.

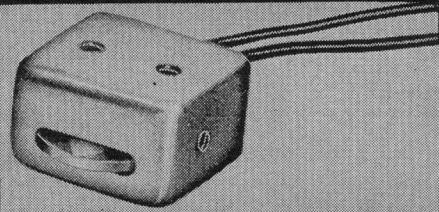

Featuring:

1. High-permeability ferrite as base material
2. Special alloy for area in contact with tape
3. Guaranteed life-span 3x existing heads!
4. Narrow-gap molding through unique mfg. process
5. Hi-frequency reproduction excellent under all conditions

Series No.	KF-18501 (Cassette St.)	KF-13101 (8 Tr. St. Pbk.)	KF-24501 (8mm cine- talkie)	KF-12504 (4 Tr. St.)
Sensitivity	-71dBm	-60dBm	-75dBm	-52dBm
Track Width	0.6mm	0.508mm	0.6mm	1.05mm
Crosstalk	45dB+	60dB+	60dB+	60dB+
Gap	1.5 mic.	2 mic.	3 mic.	3 mic.

Another foster first:

Industrial heads for machine tool numerical control—signal readout and applicable track width of 100mm.

Speakers, Microphones, Audio Equipment

FOSTER ELECTRIC CO., LTD.

Akishima, Tokyo, Japan
 Cable: Fosterelectric Akishima
 230 N. Michigan Ave., Suite 2330
 Chicago, Ill. 60601 (☎263-7107)

FILM THICKNESS MONITOR TVF-1



◀ Crystal Oscillator Type

SPECIFICATION:

● Stability of Detected Frequency

Within 1c/s (continuous operation for 10 minutes)

Within 5c/s (continuous operation for 1 hour)

* Under a constant temperature and humidity

● Covering Range of Measurement

x1000 scale:.....0—10Kc/s, Min. reading 100 c/s

x100 scale:.....0—1 Kc/s, Min. reading 10 c/s

x10 scale:.....0—100c/s, Min. reading 1 c/s

A single piece of sensing crystal can be utilized until the frequency variation reaches as low as 200Kc/s. This is equivalent to 20 in thickness for SiO₂ (i.e., specific gravity: 2.65). Thus it will be possible to utilize the same sensing crystal for 20 times in case the frequency variation per each time of use is 10Kc/s.

● Power Consumption

AC 100/220V, single phase (50 or 60c/s), 80W (Max.)

● Dimensions and Weight

Indicator assembly: 496mm(W) × 400mm(D) × 179mm(H), 8Kg

Oscillator unit: 77mm(W) × 158mm(D) × 124mm(H), 0.8Kg

Deposition speed meter: 96mm(W) × 150mm(D) × 120mm(H), 0.8Kg

OPTIONAL ATTACHMENT:

• Water-cooled type FW crystal holder

• Plug-in type Deposition speed meter

Newly developed technique on our long experience in quartz crystals and our unique circuit construction enable precise measurement of film thickness (conductor/non-conductor) in the evaporation. With the installed relay, the film thickness can be controlled automatically.

TOYO COM
TOYO COMMUNICATION
EQUIPMENT CO., LTD.

EXPORT DEPARTMENT:
TORANOMON BLDG.,
15, SHIBA-TORANOMON, MINATO-KU,
TOKYO, JAPAN.
CABLE: EXPORTOYOCOM TOKYO

Shinon Electric Co., Ltd., 2-30 Kami Hosoda-cho, Higashiumiyoshi-ku, Osaka; JEG, Stegstrasse 34, 6000 Frankfurt/M., Germany (61-35-95)

Shinyei Co., Ltd., 2-108 Nakayamatedori, Ikuta-ku, Kobe (Shinyeicap Kobe)

Showa Musen Kogyo Co., Ltd., 6-5-5 Togoshi, Shinagawa-ku, Tokyo (Showamusen)

Sonics Corp., 2-12 Kojimachi, Chiyoda-ku, Tokyo

Sony Corp., 351 Kitashinagawa-6, Shinagawa-ku, Tokyo (Sonycorp); 500 W. Florence Ave., Inglewood, Calif. 90307 (OR 8-8141)

Soshin Electric Co., Ltd., 1-18-18 Nakamagome, Ohta-ku, Tokyo (Soshin-capacitor)

Space Mechatronics, Inc., 4-19 Ebie-Kami, Fukushima-ku, Osaka

Sumida Electric Co., Ltd., 2-1279 Kanamachi, Katsushika-ku, Tokyo (Suden-kikogyo)

Sumitomo Special Metals Co., Ltd., 5-22 Kitahama, Higashi-ku, Osaka (Spec-metalsumit Osaka)

Sun Dengyosha Co., Ltd., 3-1-10 Togoshi, Shinagawa-ku, Tokyo

Susumu Industrial Co., Ltd., 6 Shonouchi-cho, Nakadoji, Shimogyo-ku, Kyoto

TDK Electronics Co., Ltd., 2-14-6 Uchikanda, Chiyoda-ku, Tokyo (Tdkcore); 82 Wall St., New York, N.Y. 10005 (425-7070); 6151 W. Century Blvd., Los Angeles, Calif. 90045 (OR 0-5515)

TDS Electronics Co., Ltd., Apond Bldg., 1-7-12 Soto-Kanda, Chiyoda-ku, Tokyo (Tdselectronics)

Tabai Seisakusho Co., Ltd., 2-18 Doshinocho Minami, Kita-ku, Osaka (Tabai-chamber Osaka)

Tabuchi Electric Co., Ltd., 1-10 Mitejima-Higashi, Nishiyodogawa-ku, Osaka (Zebraelec Osaka)

Taiyo Denki Co., Ltd., 3-1-12 Sunamichi-cho, Sakai-city, Osaka (Solidtaiyohm Osaka)

Taiyo Electronics Corp., 6-5-1 Togoshi, Shinagawa-ku, Tokyo (Apollhagita)

Takamisawa Electric Co., Ltd., 1-4-35 Koyama, Shinagawa-ku, Tokyo

Takeda Riken Industry Co., Ltd., 285 Asahi-cho, Nerima-ku, Tokyo (Trionics)

Tamura Seisakusho, Ltd., 433 Higashi-Oizumi-machi, Nerima-ku, Tokyo (Nip-pontamradio); Tamradio Co., Ltd., 501 Larree Bldg., 5817 N. Kenmore Ave., Chicago, Ill. 60626 (312-561-3842)

Tanita Mfg. Co., Ltd., 1-14 Maenochi, Itabashi-ku, Tokyo (Tanitamfg)

Tateisi Electronics Co., Ltd., 10 Tsuchido, Hanazono-cho, Ukyo-ku, Kyoto (Omronelco Kyoto); 23-25 E. 26th St., New York, N.Y. 10010 (OR 9-6858)

Teikoku Tsushin Kogyo Co., Ltd., 335 Nishi Nakamachi, Kariyado, Kawasaki-city (Teitsu Kawasaki)

Telecon Corp., 5-4-6 Osaki, Shinagawa-ku, Tokyo (Telecontoa)

Tensho Electric Industries Co., Ltd., 1-3-3 Koyama, Shinagawa-ku, Tokyo (Tenshoden)

Toa Electric Co., Ltd., 5 Hyogo-Shimosawa, Kobe (Toaelectric Kobe)

Tohoku Metal Industries, Ltd., 4-7 Ginza-Higashi, Chuo-ku, Tokyo (Tohokumetal)

Tokai Communication Apparatus Corp., Nakahara 816, Shizuoka-city (Tokaicac

Shizuoka); 500 Fifth Ave., New York, N.Y. 10036

Toko, Inc., 2-1-17 Higashi-Yukigaya, Ohta-ku, Tokyo (Radiocoilab); 350 Fifth Ave., New York, N.Y. 10001 (565-3767)

Tokyo Cosmos Electric Co., Ltd., 1-303 Horinouchi, Suginami-ku, Tokyo (Cosmosdenki)

Tokyo Denki Co., Ltd., 4-9 Nihonbashi-Honcho, Chuo-ku, Tokyo (Electromarcon)

Tokyo Denpa Co., Ltd. (Tokyo Electric Wave), 5-6-11 Chuo, Ohta-ku, Tokyo (Tewdenpa)

Tokyo Print Industrial Co., Ltd., 782 Shimoishihara, Chofu-city, Tokyo

Tokyo Seimitsu Co., Ltd., Iida Bldg., 3-24-9 Nishi-Shinbashi, Minato-ku, Tokyo (Tskdeltax)

Tokyo Shibaura Electric Co., Ltd. (Toshiba), 1-1 Uchisaiwaicho, Chiyoda-ku, Tokyo (Toshiba); 530 Fifth Ave., New York, N.Y. 10036 (587-5471); 465 California St., San Francisco, Calif. 94104 (434-2340); 141 W. Jackson Blvd., Chicago, Ill. 60604 (427-9382); 165 S. King St., Honolulu, Hawaii 96813 (569-211); Berliner Allee 26, Duesseldorf 1, Germany (29648-9)

Tokyo Vacuum Machinery Co., Ltd., 2-9-23 Yaguchi, Ohta-ku, Tokyo (Vacuumomoya)

Tonegen Electric Mfg. Co., Ltd., 1-37 Furuichi Minami-Dori, Joto-ku, Osaka

Toritsu Tsushin Kogyo Co., Ltd., 5-20-8 Nishi-Gotanda, Shinagawa-ku, Tokyo; Graybar Bldg., Room 556-8, 420 Lexington Ave., New York, N.Y. 10017

Towa Chikudenki Co., Ltd., 81 Ojiri, Hatano-city, Kanagawa - prefecture (Condensertowa)

Toyo Communication Equipment Co., Ltd., Toranomon Bldg., 15 Shiba-Toranomon, Minato-ku, Tokyo (Exportoyocom)

Toyo Conepaper Co., Ltd., 2-184 Nakanocho, Miyakojima-ku, Osaka

Toyo Electronics Industry Corp., 21 Sain-Misosaki-cho, Ukyo-ku, Kyoto (Rohm Kyoto); JEG, Stegstrasse 34, 6000 Frankfurt/M., Germany (61-35-95)

Toyo Musen Co., Ltd., 1-8-10 Wakabayashi, Setagaya-ku, Tokyo (Toyoradicator); 938 Merchandise Mart, Chicago, Ill. 60654

Tsuda Electric Meters Co., Ltd., 50 Kinugasacho, Kita-ku, Osaka

Vibration Development Co., Ltd., Konishi Bldg., 1-108 Tenjinbashi-Suji, Kita-ku, Osaka

Watanabe Instruments Corp., 3-19 Nishi-Shinagawa, Shinagawa-ku, Tokyo

Yanagimoto Mfg. Co., Ltd., Kiyamachi Sanjo Sagaru, Nakagyo-ku, Kyoto (Kyoyanagi Kyoto)

Yaskawa Electric Mfg. Co., Ltd., Ohtemachi Bldg., 1-4 Ohtemachi, Chiyoda-ku, Tokyo; Pan Am Bldg., 200 Park Ave., New York, N.Y. 10017; Grurerstrasse 38, 4 Duesseldorf, Germany

Yokogawa Electric Works, Ltd., Musashino-city, Tokyo (Yokogawa); 1995 Palmer Ave., Larchmont, N.Y. 10538 (914-834-3550); Blumenau 48, 2 Hamburg 22, Germany (25-00237)

Yokowo Mfg. Co., Ltd., 7-5 Takinogawa, Kita-ku, Tokyo (Shinebright)

Youth Electric Co., Ltd., 1-25-13 Nishi-Ochiai, Shinjuku-ku, Tokyo