

esi.

Electro Scientific Industries

13900 N.W. SCIENCE PARK DRIVE • PORTLAND, OREGON 97229

**BRIDGES
AND
ACCESSORIES**

APRIL 1967
REPLACES JUNE 1966

MODEL
250DE

Instruction Manual
**UNIVERSAL
IMPEDANCE BRIDGE**

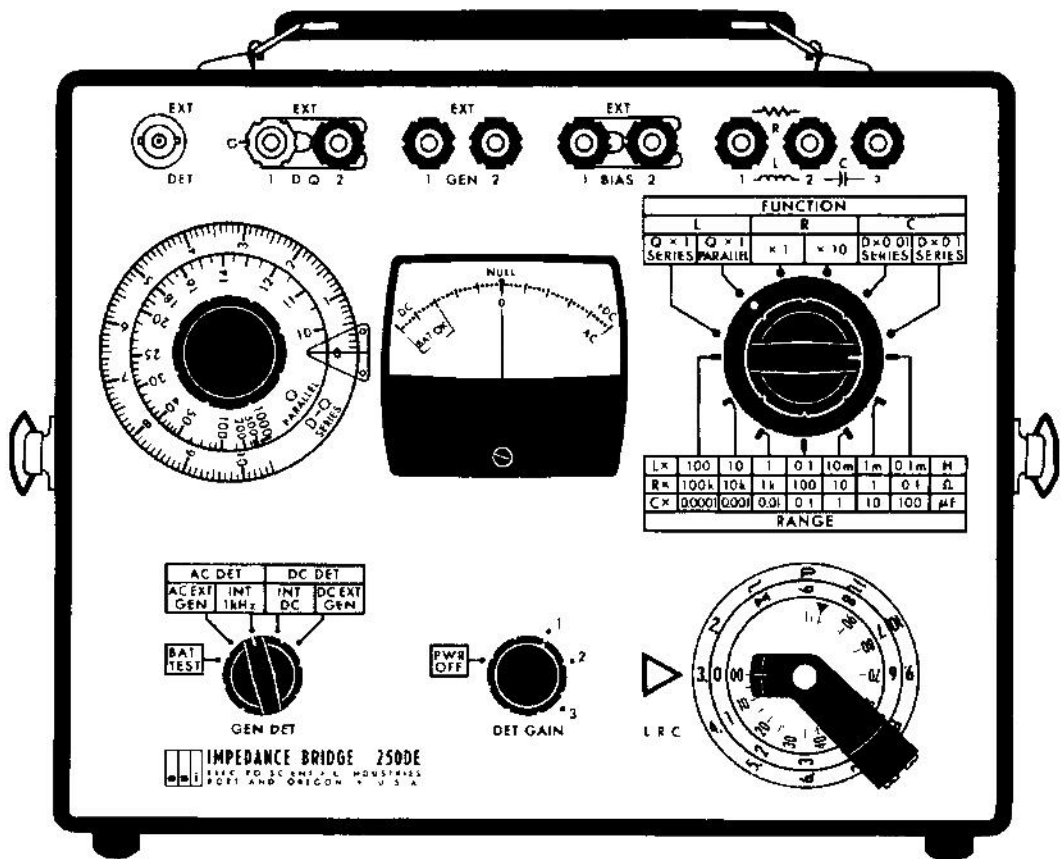

SERIAL NUMBER: _____

PART NUMBER: 13202

The following table lists the most recent revision of each page at the present printing:

<u>PAGES</u>	<u>DATE</u>
Title	4/67
A	4/67
i and ii	6/66
1-1	6/66
1-2	4/67
1-3	6/66
2-1 thru 2-3	6/66
3-1 thru 3-5	6/66
4-1 thru 4-5	6/66
4-6	4/67
4-7 thru 4-10	6/66
5-1 thru 5-12	6/66
6-1 thru 6-7	6/66
7-0 thru 7-2	4/67

TABLE OF CONTENTS

I. INTRODUCTION	1-1
1.1 DESCRIPTION	1-1
1.2 SPECIFICATIONS	1-2
II. OPERATION	
2.1 CONTROLS	2-1
2.2 CONNECTIONS	2-2
2.3 BASIC OPERATION	2-2
III. RESISTANCE MEASUREMENT	
3.1 DC RESISTANCE MEASUREMENT	3-1
3.2 AC RESISTANCE MEASUREMENT	3-3
3.3 NOTES ON RESISTANCE MEASUREMENT	3-5
3.3.1 Low Resistance	3-5
3.3.2 High Resistance	3-5
IV. CAPACITANCE MEASUREMENT	
4.1 NORMAL CAPACITANCE MEASUREMENT	4-1
4.2 CAPACITANCE MEASUREMENT WITH EXTENDED D RANGE	4-3
4.3 CAPACITANCE MEASUREMENT USING DC BIAS	4-5
4.3.1 DC Bias Supply	4-5
4.3.2 Operating Procedure	4-6
4.4 VOLTAGE ACROSS UNKNOWN CAPACITOR	4-8
4.5 NOTES ON CAPACITANCE MEASUREMENT	4-9
4.5.1 Series and Parallel Capacitance	4-9
4.5.2 Low Capacitance Measurements	4-9
4.5.3 High Capacitance Measurements	4-10
V. INDUCTANCE MEASUREMENT	
5.1 NORMAL INDUCTANCE MEASUREMENTS	5-2
5.2 INDUCTANCE MEASUREMENT WITH EXTENDED Q RANGE	5-3
5.2.1 Preliminary Procedure	5-3
5.2.2 Parallel Inductance	5-3
5.2.3 Series Inductance	5-4
5.3 INDUCTANCE MEASUREMENT USING DC	5-6
5.3.1 DC Supply	5-6
5.3.2 Operating Procedure	5-6
5.4 VOLTAGE AND CURRENT IN UNKNOWN INDUCTOR	5-9
5.4.1 Voltage	5-9
5.4.2 Current	5-10
5.5 NOTES ON INDUCTANCE MEASUREMENT	5-11
5.5.1 Series and Parallel Inductance	5-11
5.5.2 Low-Inductance Measurements	5-12
5.5.3 High-Inductance Measurements	5-12
IV. USEFUL MEASUREMENT TECHNIQUES	
6.1 EXTERNAL DETECTOR	6-1
6.2 EXTERNAL DC GENERATOR	6-2
6.3 EXTERNAL AC GENERATOR	6-3

6.4	OPERATION AT FREQUENCIES OTHER THAN ONE KILOHERTZ	6-4
6.4.1	D and Q Corrections	6-4
6.4.2	Accuracy	6-4
6.5	SLIDING BALANCE	6-5
6.6	EXTEND LEADS WITH AC MEASUREMENTS	6-6
VII.	REPLACEMENT PARTS	7-0

The following are registered trademarks of Electro Scientific Industries, Inc.:

ESI® Electro Scientific Industries, Inc.
 ESIAC® Algebraic Computer
 ESIPOT® Potentiometer
 DEKABOX® Decade Resistors and Capacitors
 DEKABRIDGE® Bridge Circuit
 DEKADIAL® Decade Dials
 DEKAMATIC® Automatic Unit
 DEKAPOT® Decade Potentiometers
 DEKASTAT® Decade Rheostat
 DEKAPACITOR® Decade Capacitor
 DEKAVIDER® Decade Voltage Divider
 KELVIN KLIPS® Four-terminal Clips
 KELVIN KLAMPS® Four-terminal Clamps
 PORTAMETRIC® Portable Measuring Instrument
 PVB® Potentiometric Voltmeter Bridge

Application for registration has been filed for the following:

DEKATRAN Decade Transformer

SECTION I

INTRODUCTION

1.1 DESCRIPTION

The esi[®] Model 250DE Impedance Bridge is an instrument that measures resistance, inductance, capacitance, and the dissipation factor (D) and the storage factor (Q) of inductors and capacitors.

The instrument is battery operated and completely portable. An internal generator supplies ac and dc, and an internal solid-state ac-dc detector indicates bridge balance.

Figure 1-1 is a simplified schematic diagram of the instrument in each of the four modes of operation: resistance, capacitance, and series and parallel inductance.

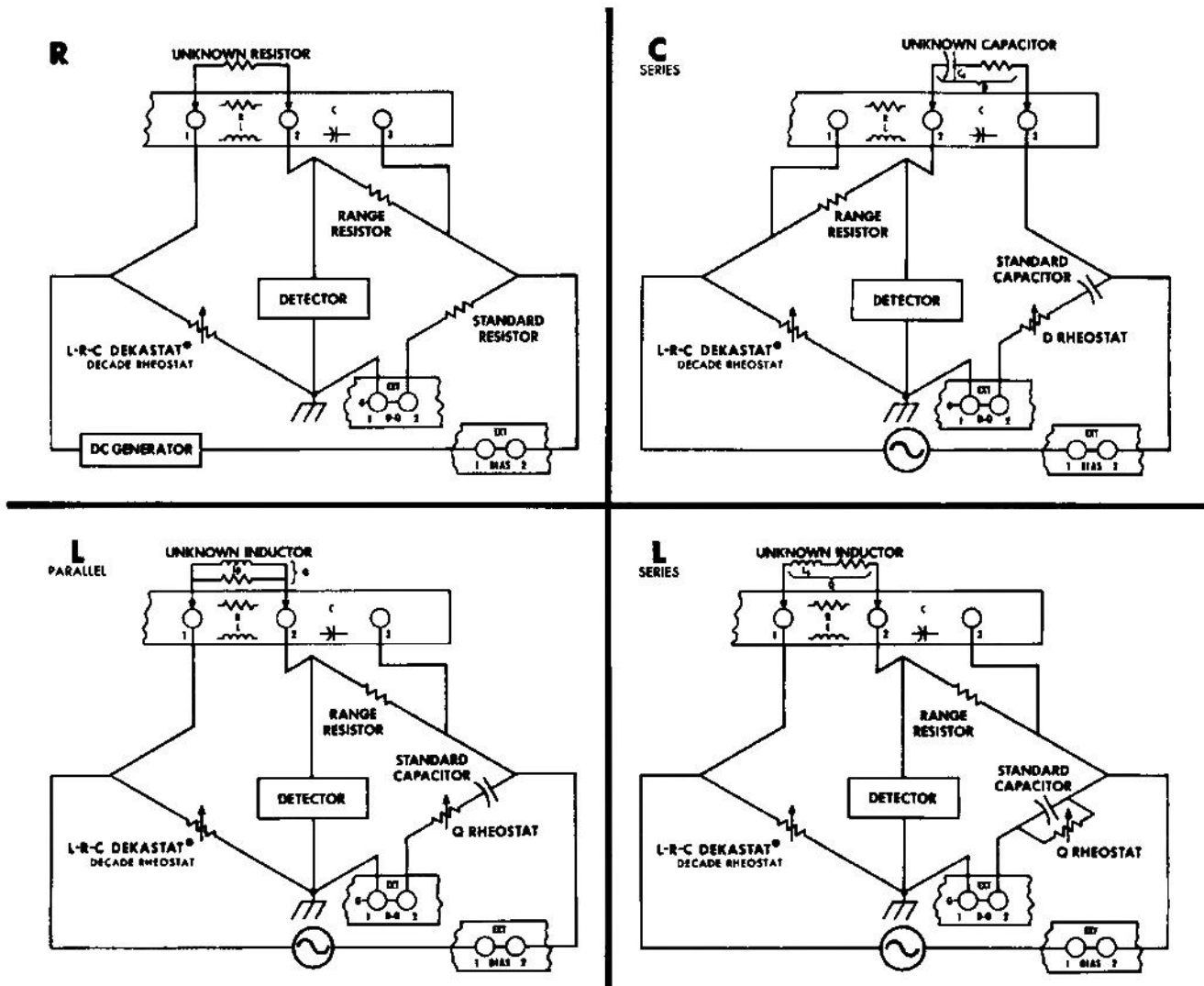

Figure 1-1. Simplified Schematic Diagrams

1.2 SPECIFICATIONS

Detector: A solid-state ac-dc-amplifier null detector

AC Characteristics:

Input Impedance: Approximately $1\text{ M}\Omega$

Sensitivity: Continuously variable, $10\ \mu\text{V}$ minimum detectable signal

Frequency: 1 kHz (kilocycle)

DC Characteristics:

Input Resistance: Approximately $1\text{ M}\Omega$

Sensitivity: Continuously variable to 1 millivolt full scale, 20 microvolts minimum detectable signal.

Generator: A solid-state ac generator with transformer output and diode rectifiers for dc.

AC Characteristics:

Open-Circuit Voltage: 2V rms

Short-Circuit Current: 70 mA

DC Characteristics:

Open-Circuit Voltage: 3V

Short-Circuit Current: 40 mA

Supply Power: Four 1.5-volt size D cells

Battery Life: Approximately 500 hours

FUNCTION	RANGES		ACCURACY		
	MAGNITUDE	D OR Q	RANGES	MAGNITUDE	D OR Q
Resistance	0-12 M Ω in eight ranges, 0.1 m Ω per dial division on lowest R range		All eight ranges	0.1% + 1 dial division	
Inductance (Series)	0-1200 H in seven ranges, 0.1 μ H per dial division on lowest L range	Q = 0 to 10.5, 0.1 per dial division	Highest	0.3% + 1 dial division + 4.0% \times 1/Q	0.040 (1 + Q ²) + 0.02Q
			Other five	0.3% + 1 dial division + 0.5% \times 1/Q	0.005 (1 + Q ²) + 0.02Q
			Lowest	0.3% + 1 dial division + 4.0% \times 1/Q	0.040 (1 + Q ²) + 0.02Q
Inductance (Parallel)	0-1200 H in seven ranges, 0.1 μ H per dial division on lowest L range	Q = 10 to 1000, scale reads Q dial is linear in 1/Q	Highest	0.3% + 1 dial division + 4.0% \times 1/Q	0.040 (1 + D ²) + 0.02Q
			Other five	0.3% + 1 dial division + 0.5% \times 1/Q	0.005 (1 + D ²) + 0.02Q
			Lowest	0.3% + 1 dial division + 4.0% \times 1/Q	0.040 (1 + D ²) + 0.02Q
Capacitance (Series)	0-1200 μ F in seven ranges, 0.1 pF per dial division on lowest C range	D = 0 to 1.05 in two ranges, 0.001 per dial division on lowest D range	Highest	0.2% + 1 dial division + 4.0% \times D	0.040 (1 + D ²) + 0.02D
			Other five	0.2% + 1 dial division + 0.5% \times D	0.005 (1 + D ²) + 0.02D
			Lowest	0.2% + 1 dial division + 4.0% \times D	0.040 (1 + D ²) + 0.02D

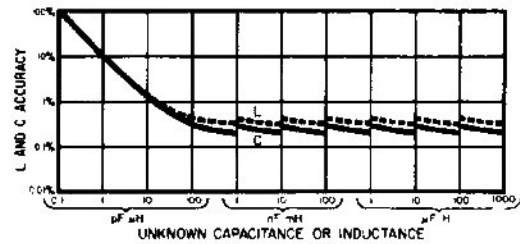
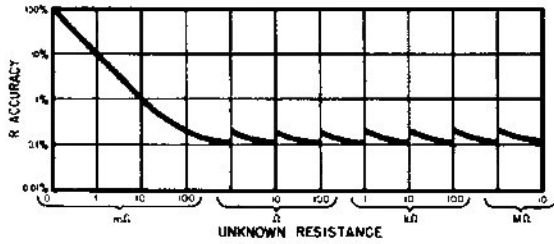

The specified accuracy for measurements of resistors, Low-loss inductors and capacitors.

The specified accuracy for measurements of D and Q.

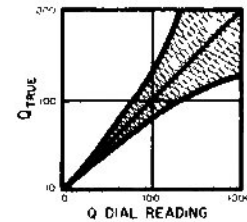
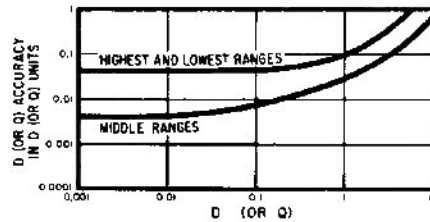

The accuracy of inductance and capacitance measurements is influenced by the D and Q value. This curve shows the accuracy to be expected at various D and Q values.

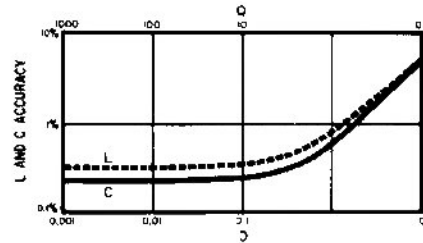

Figure 1-2.

SECTION II OPERATION

The controls and connections necessary to operate the Model 250DE Impedance Bridge are shown in Figure 2-1.

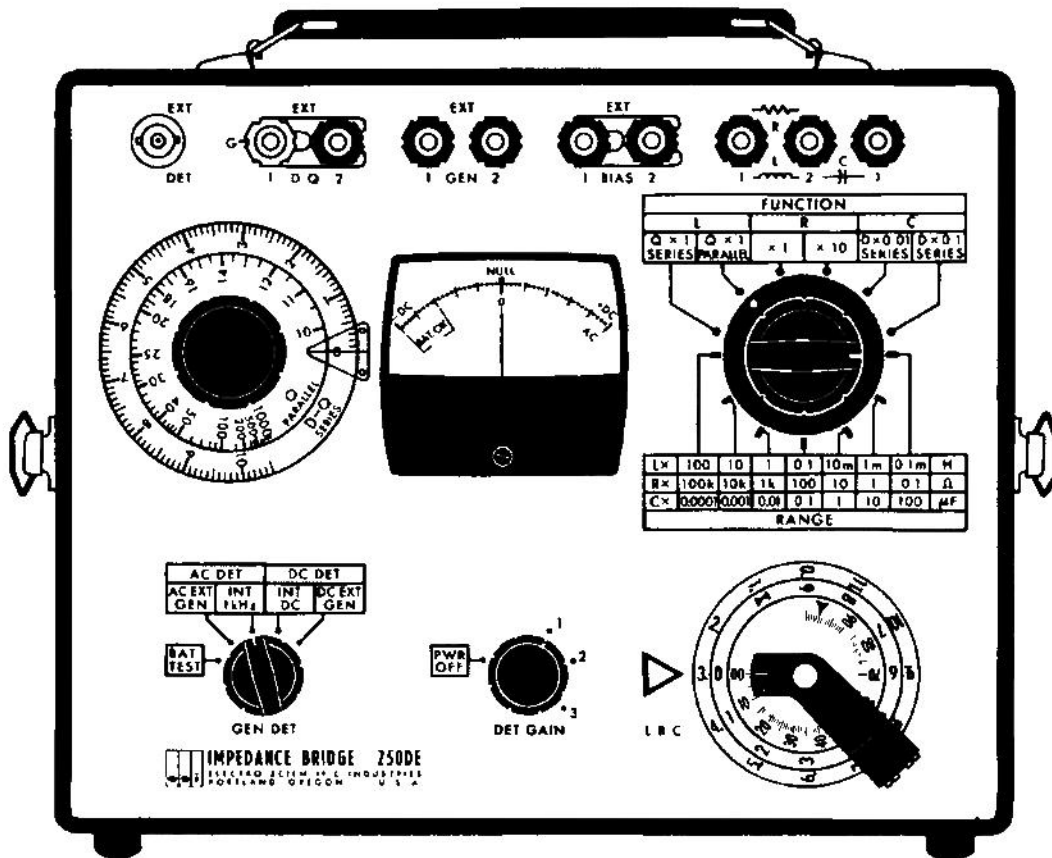

Figure 2-1. Model 250DE Panel View

2.1 CONTROLS

FUNCTION switch selects the type of bridge circuit that will measure resistance, capacitance, or inductance.

RANGE switch selects the multiplier for each function.

L-R-C decade dials are a DEKASTAT® Decade Resistor that is the main balancing element of the bridge. The setting of the dials after the bridge is balanced indicates the value of the inductance, resistance, or capacitance.

D-Q dial is used to balance the phase of the capacitance or inductance bridge. The setting of the dial after the bridge is balanced indicates the value of dissipation factor (D) or storage factor (Q).

GEN-DET switch selects bridge generator and detector connections, ac or dc, internal or external generator. The switch also connects the internal batteries to the battery test circuit.

DET GAIN control adjusts the sensitivity of the ac-dc detector and turns on power to the generator.

2.2 CONNECTIONS

R, L, and C terminals 1, 2, and 3 are used to connect unknown resistors, inductors, and capacitors to the bridge. Resistors and inductors are connected between terminals 1 and 2, capacitors between terminals 2 and 3.

EXT BIAS terminals are normally connected with a shorting lug. They allow insertion of a dc voltage or current to bias capacitors or inductors.

EXT GEN terminals provide a connection to the bridge for an external generator. When the GEN-DET switch is in the EXT AC GEN position, the terminals connect to an isolation transformer so that a grounded external generator can be used. When the GEN-DET switch is in the EXT DC GEN position, the terminals connect directly to the bridge.

EXT D-Q terminals are normally connected with a shorting lug. They allow an external rheostat to extend the range of the D-Q dial.

EXT DET connector is a BNC coaxial socket that allows an external detector to be used with the instrument. It is connected to the bridge at all times.

2.3 BASIC OPERATION

Simple operating instructions are inside the instrument lid. Figure 2-2 is a reproduction of these instructions.

BATTERY REPLACEMENT

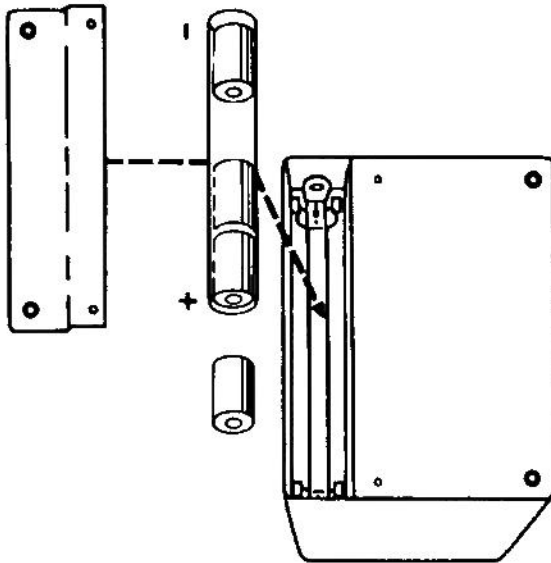

Check the battery before each day's operation. Turn DET GAIN control to 1 and set GEN-DET switch to BAT TEST. If the meter deflection beyond the BAT OK mark, the battery is good.

The battery consists of four 1.5-volt D cells. To change battery, remove cover from battery compartment using a screwdriver. Replace cells as shown in illustration.

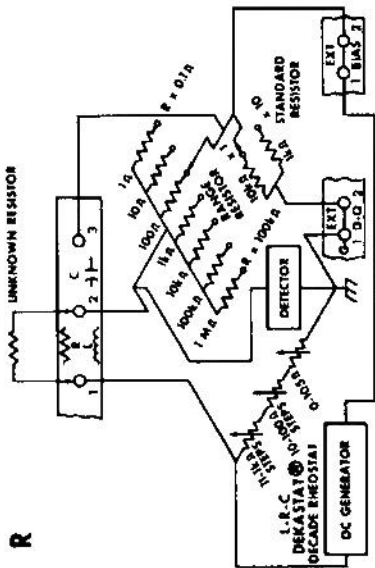

DC RESISTANCE MEASUREMENTS

- 1 Turn DET GAIN control to 2
- 2 Set FUNCTION switch to R x 1 or R x 10.
- 3 Set L-R-C decade dials to 3,000.
- 4 Connect the unknown resistor to R-L terminals 1 and 2.
- 5 Set GEN-DET switch to INT DC.
- 6 Adjust RANGE switch for minimum detector deflection.
- 7 Adjust L-R-C decade dials for null, turning DET GAIN control clockwise to increase sensitivity as necessary.
- 8 The measured resistance is the product of the L-R-C decade dial setting times the RANGE and FUNCTION switch settings.

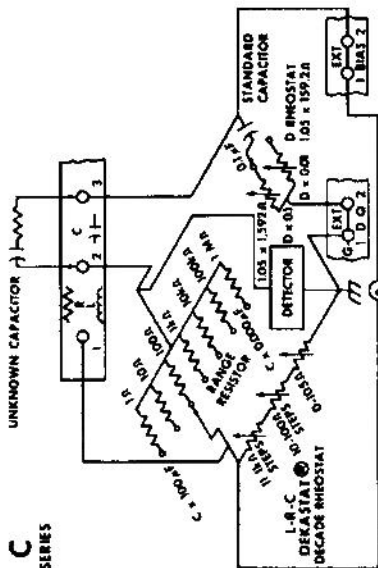

CAPACITANCE MEASUREMENTS

- 1 Turn DET GAIN control to 1
- 2 Set FUNCTION switch to C, D x 0.1 or D x 0.01 SERIES
- 3 Set L-R-C decade dials to 3,000 and D-Q dial to 0
- 4 Connect the unknown capacitor to C terminals 2 and 3
- 5 Set GEN-DET switch to INT 1 kHz.
- 6 Adjust RANGE SWITCH for minimum detector deflection
- 7 Adjust L-R-C decade dials and D-Q dial alternately for minimum meter deflection, turning DET GAIN control clockwise to increase sensitivity as necessary
- 8 The measured capacitance is the product of the L-R-C decade dial setting
- 9 The measured dissipation factor (D) is the product of the D-Q setting times the FUNCTION SWITCH setting

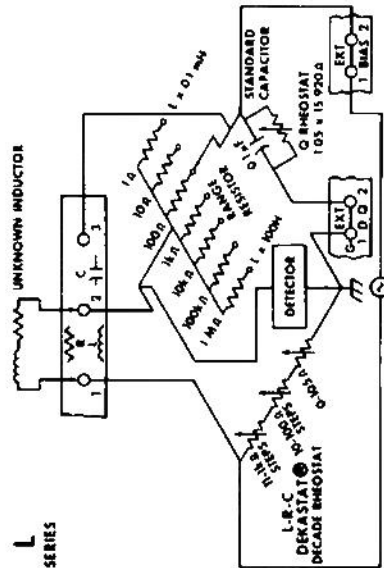

INDUCTANCE MEASUREMENTS

- 1 Turn DET GAIN control to 1
- 2 Set FUNCTION switch to L PARALLEL (R-Q) is greater than 10, to L SERIES if Q is less than 10.
- 3 Set L-R-C decade dials to 3,000 and D-Q dial to maximum
- 4 Connect the unknown inductor to R-L terminals 1 and 2
- 5 Set GEN-DET switch to INT 1 kHz.
- 6 Adjust RANGE switch for minimum detector deflection
- 7 Adjust L-R-C decade dials and D-Q dial alternately for minimum meter deflection, turning DET GAIN control clockwise to increase sensitivity as necessary
- 8 The measured inductance is the product of the L-R-C decade dial setting times the RANGE switch setting
- 9 The measured storage factor (Q) is read directly from the D-Q dial, inner scale for parallel and outer scale for series inductance

Figure 2-2. Operating Instructions

SECTION III

RESISTANCE MEASUREMENT

Resistance is usually measured with direct current for maximum accuracy. The Model 250DE Impedance Bridge can be used to measure resistance with alternating current, but external reactance compensation is usually required.

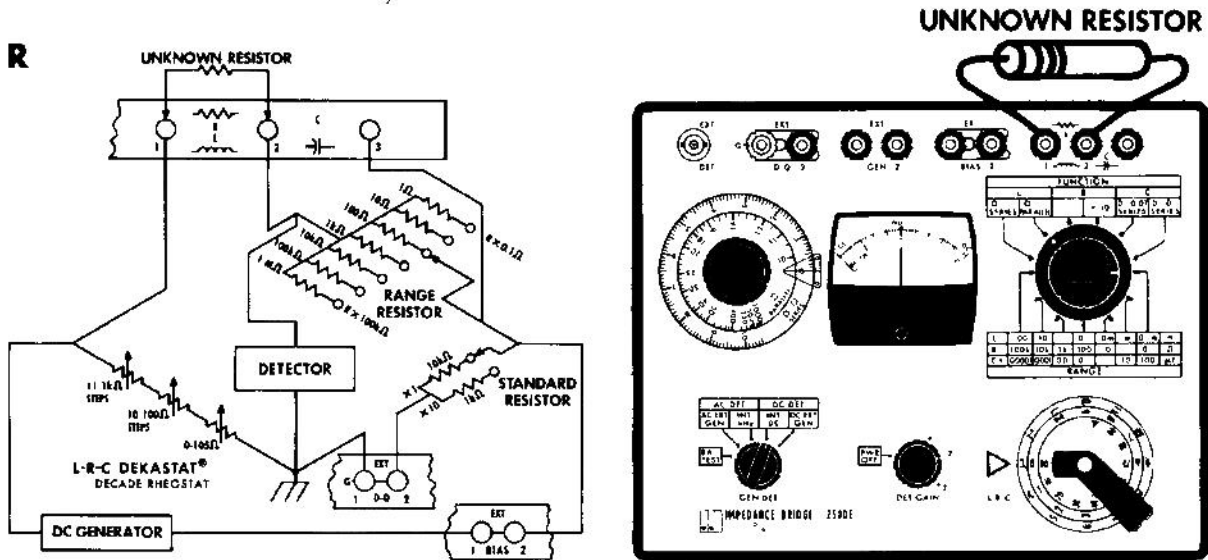

Figure 3-1. DC Resistance Measurement

3.1 DC RESISTANCE MEASUREMENT

- | | |
|---|--|
| 1. Turn DET GAIN control to 2. | This turns on all power to the instrument. |
| 2. Set GEN-DET switch to INT DC. | If an external detector or generator is required, see paragraph 6.1 or 6.2. |
| 3. Set FUNCTION switch to R × 1 or R × 10. | Use the R × 10 position for resistors between 1.2 and 12 megohms. |
| 4. Set L-R-C decade dials to 3,000. | This makes it easier to find the correct range. |
| 5. Connect the unknown resistor to R-L terminals 1 and 2. | Make good contact with the terminals. |
| 6. Adjust RANGE switch for minimum detector deflection. | This sets the range so that the value can be found with maximum resolution on the L-R-C dials. |

7. Adjust L-R-C decade dials for null.

Each time the detector indication approaches zero, turn the DET GAIN control clockwise to increase sensitivity.

8. Read the measured resistance as the product of L-R-C dial setting times RANGE and FUNCTION switch settings.

If L-R-C dial reading is less than 1.200, turn RANGE switch one step counterclockwise and repeat step 7 in order to take full advantage of the resolution.

9. Disconnect the unknown resistor and turn DET GAIN control to PWR OFF before leaving the instrument.

3.2 AC RESISTANCE MEASUREMENT

For greatest accuracy, resistors should be measured with dc. The accuracy of ac resistance measurements made with the Model 250DE Impedance Bridge is 0.3% for resistors of low reactance with resistance between 1 ohm and 1 kilohm.

The capacitor and potentiometer shown connected in Figure 3-2 compensate for series inductance or parallel capacitance. It is impossible to separate the correction for the unknown resistance from the correction for the rest of the bridge circuit.

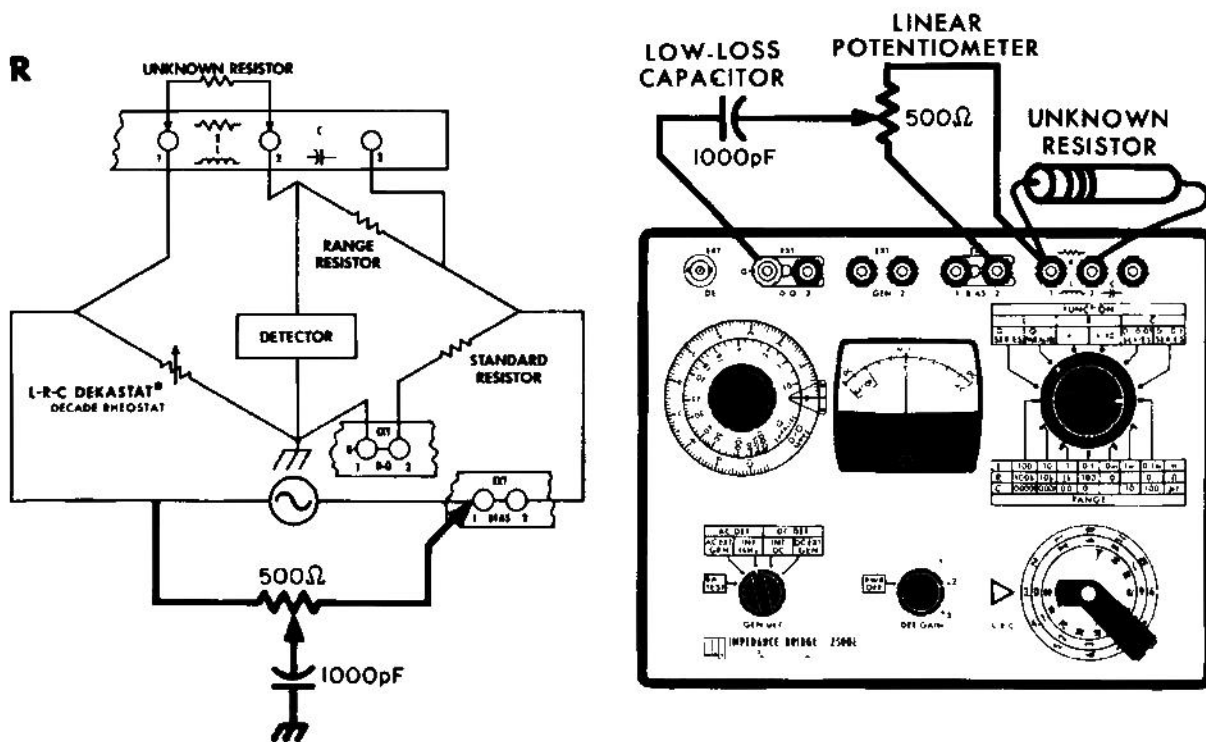

Figure 3-2. AC Resistance Measurement

- | | |
|--|--|
| <ol style="list-style-type: none"> 1. Turn DET GAIN control to 1. 2. Set FUNCTION switch to R X 1 or R x 10. 3. Set L-R-C decade dials to 3,000. 4. Connect the unknown resistor to R-L terminals 1 and 2. 5. Set GEN-DET switch to INT 1kHz. | <p>This turns on all power to the instrument.</p> <p>Use the R x 10 position for resistors between 1.2 and 12 megohms.</p> <p>This makes it easier to find the correct range.</p> <p>Make good contact with the terminals.</p> <p>If an external ac detector or generator is required, see paragraph 6.1 or 6.3.</p> |
|--|--|

6. Adjust RANGE switch for minimum detector deflection.
Turn DET GAIN control clockwise to increase sensitivity if necessary. If no range gives noticeably less deflection than any other, try measuring resistance on dc for a first approximation of the range.
7. Try to balance bridge by adjusting L-R-C dials.
The null indication on the meter may not be very sharp, which indicates that there is an uncompensated phase shift.
8. If a null cannot be reached, connect potentiometer and capacitor to the terminals as shown in Figure 3-2.
Be sure to use a low-loss capacitor; air and polyethylene dielectrics are sufficient.
9. Balance the bridge by adjusting L-R-C decade dials and external potentiometer alternately.
A higher value capacitor may be necessary to compensate for phase shift when measuring resistors that have large reactive components.
10. Read measured resistance as the product of L-R-C dials times RANGE and FUNCTION switch settings.
The measured resistance is correct for an equivalent circuit consisting of a resistor and a capacitor in parallel or a resistor and inductor in series.
11. Disconnect the unknown resistor and turn DET GAIN control to PWR OFF before leaving the instrument.

3.3 NOTES ON RESISTANCE MEASUREMENT

3.3.1 Low Resistance

On the low resistance ranges, the lead resistance becomes significant. A procedure to correct for the lead resistance by finding its value and subtracting it from the measured resistance is:

1. Short the test leads together at the point at which they are to be connected to the unknown resistor.
2. Measure the resistance of the leads. There is no loss of accuracy if the resistance of the leads is measured on the same range that the unknown resistor will be measured on.
3. Connect the leads to the unknown resistor and measure the resistance.
4. Subtract the lead resistance (step 2) from the measured resistance (step 3).

3.3.2 High Resistance

On the high resistance ranges, take care to avoid leakage across a resistor under test. Insulation with a resistance of 10^9 ohms, which is adequate for most purposes, will cause a measurement error of 1% if it shunts a 10-megohm resistor.

SECTION IV

CAPACITANCE MEASUREMENT

The Model 250DE Impedance Bridge measures capacitance in terms of a two-element equivalent circuit consisting of a capacitor in series with a resistor. The internal ac generator and detector of the Model 250DE bridge are tuned to 1 kilohertz (kilocycle). Other frequencies can be used but an external generator and detector are required. (See paragraph 6.4).

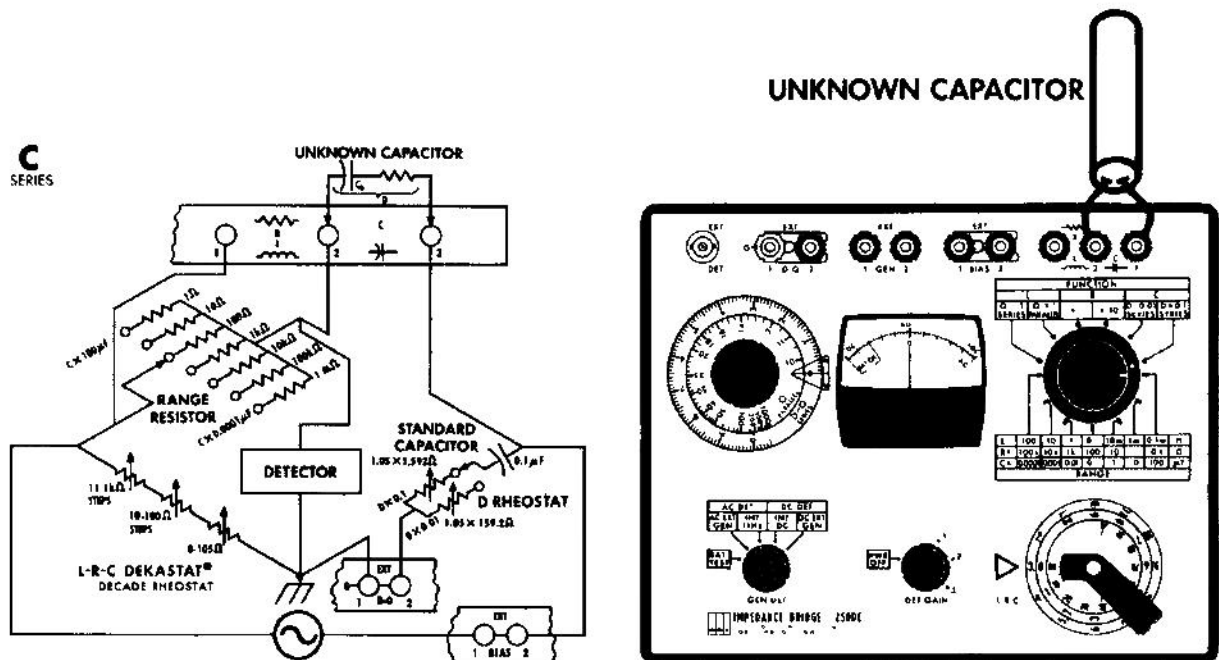

Figure 4-1. Capacitance Measurement

4.1 NORMAL CAPACITANCE MEASUREMENT

- | | |
|--|---|
| <ol style="list-style-type: none"> 1. Turn DET GAIN control to 1. | <p>This turns on all power to the instrument.</p> |
| <ol style="list-style-type: none"> 2. Set FUNCTION switch to C, D x 0.1 SERIES. | <p>This is the preferred D range for a preliminary balance</p> |
| <ol style="list-style-type: none"> 3. Set L-R-C decade dials to 3,000 and D-Q dial to 0. | <p>These settings make it easier to find the correct C range.</p> |
| <ol style="list-style-type: none"> 4. Connect the unknown capacitor to C terminals 2 and 3. | <p>Make good contact with the terminals.</p> |
| <ol style="list-style-type: none"> 5. Set GEN-DET switch to INT 1 kHz. | <p>If an external ac detector or generator is required, see paragraph 6.1 or 6.3.</p> |

6. Adjust RANGE switch for minimum detector deflection. Turn DET GAIN control clockwise to increase the sensitivity if necessary.
7. Adjust L-R-C decade dials and D-Q dial alternately for minimum meter deflection. As the null is approached, turn the DET GAIN control clockwise to increase sensitivity.
8. If D-Q dial setting is less than 1, set FUNCTION switch to $D \times 0.01$. If there is some difficulty in balancing the bridge, especially if the D is greater than 1, it may be due to a sliding balance. See paragraph 6.5.
9. Read measured capacitance as the product of L-R-C dial setting times RANGE switch setting. If L-R-C dial reading is less than 1.200, turn RANGE SWITCH one step clockwise and repeat steps 7 and 8 in order to take full advantage of the bridge resolution.
10. Read the measured dissipation factor (D) as the product of D-Q dial setting times FUNCTION switch setting. If the frequency is other than 1 kilohertz (kilocycle) see paragraph 6.4.
11. Disconnect the unknown capacitor and turn DET GAIN control to PWR OFF before leaving the instrument.

4.2 CAPACITANCE MEASUREMENT WITH EXTENDED D RANGE

The D and Q ranges of the bridge can be extended by use of an external rheostat connected to terminals provided. Figure 4-2 shows the ranges for which this technique is advisable.

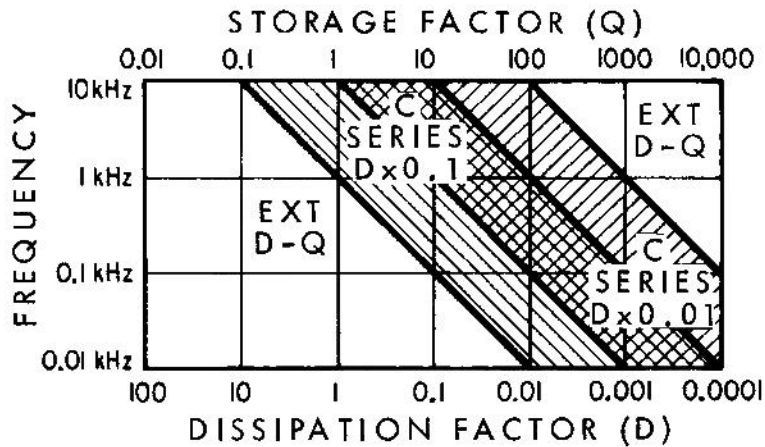

Figure 4-2. D and Q Range

1. Remove shorting lug from between EXT D-Q binding posts. The lug may be pivoted to one side.
2. Connect an external rheostat between EXT D-Q binding posts. See Figure 4-3.
3. Balance the bridge using external rheostat and D-Q dial. The measured capacitance is the product of the L-R-C dial setting times the setting of the RANGE switch.
4. Calculate D D is the dissipation factor

$$D = f_k (0.628 R_k + D_{\text{dial}})$$

f_k is the frequency in kilohertz (kilocycles)

R_k is the resistance of the external D rheostat in kilohms.

D_{dial} is the D-Q dial reading.

$f_k = 1$ if the internal generator and detector are used.

C
SERIES

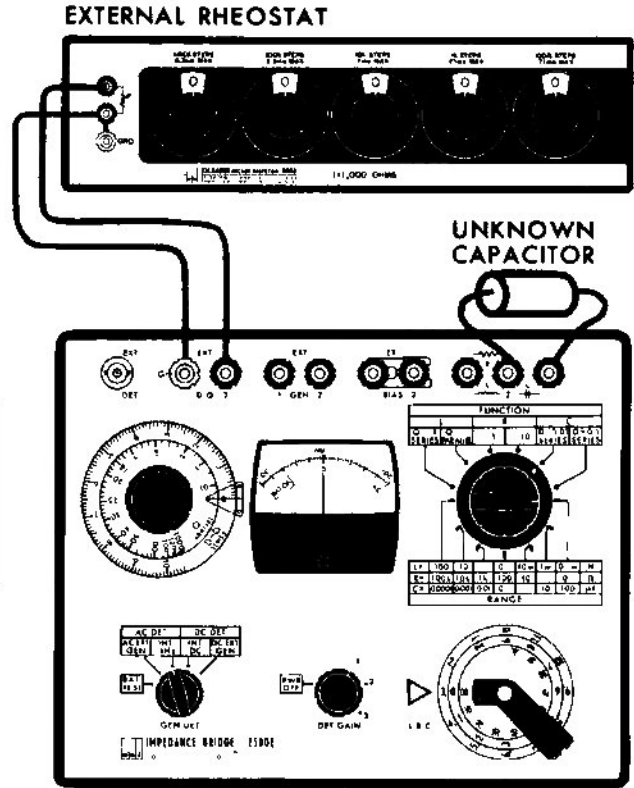
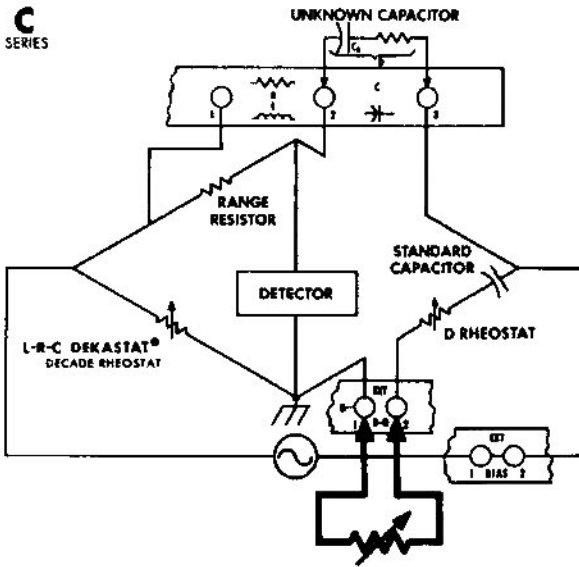

Figure 4-3. External D Rheostat

4.3 CAPACITANCE MEASUREMENT USING DC BIAS

Some capacitors need a polarizing voltage. Electrolytic and tantalum capacitors, for example, may give erroneous readings unless they are biased to prevent polarity reversal during test. Many electrolytic and tantalum capacitors can be damaged by the reverse half-cycle of an alternating current, although not generally by a low voltage level such as used in the Model 250DE Impedance Bridge.

4.3.1 DC Bias Supply

The dc bias should be supplied from a power-limited source in order to prevent damage to the bridge in case the unknown capacitor terminals are shorted. The dc supply circuit is shown in Figure 4-4.

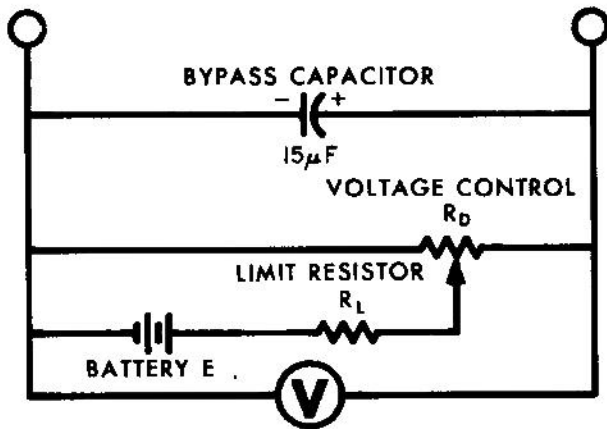

SUPPLY VOLTAGE E (VOLTS)	LIMITING RESISTOR R _L (OHMS)	VOLTAGE CONTROL R _D (OHMS)
1	0.27	2
1.5	0.56	5
2	1.0	10
3	2.7	25
4	4.7	40
4.5	5.6	50
6	10	100
9	22	250
12	39	400
15	56	500
22.5	150	1.5k
24	150	1.5k
28	220	2.5k
30	270	2.5k
45	560	3.0k
67.5	1.2k	10k
90	2.2k	20k
103.5	2.7k	30k
120	3.9k	50k
225	13k	100k
300	27k	250k

Figure 4-4. DC Bias Supply Circuit

The power in the circuit shown is limited to 1 watt by resistor R_L . Values shown are for commonly available voltages. The limiting resistors can have tolerances of 20% and should be rated at 5 watts or more. If the proper value of resistance is not available, use a larger value rather than smaller. The voltage control potentiometer may differ from the listed value by a factor of 2. It should be rated at 1 watt or more.

If a supply voltage much different from those listed is to be used, use the following formula to determine the proper value of limiting resistance:

$$R_L = \frac{E^2}{4}$$

Batteries are recommended because most line-operated power supplies have high leakage capacitance to ground and many have objectionably high dc leakage to ground.

For protection of the standard capacitor, do not use a voltage higher than 500 volts.

4.3.2 Operating Procedure

1. Set FUNCTION switch to C. With this setting, the standard capacitor and the unknown capacitor will block dc current from the other bridge arms.
2. Connect the unknown capacitor to C terminals 2 and 3. See Figure 4-5.
3. Remove shorting lug and connect dc bias supply between EXT BIAS terminals 1 and 2. See Figure 4-5. The shorting lug can be pivoted to one side.
4. Adjust dc voltage as required.
5. Measure capacitance. See paragraph 4.1 for the normal procedure.

C
SERIES

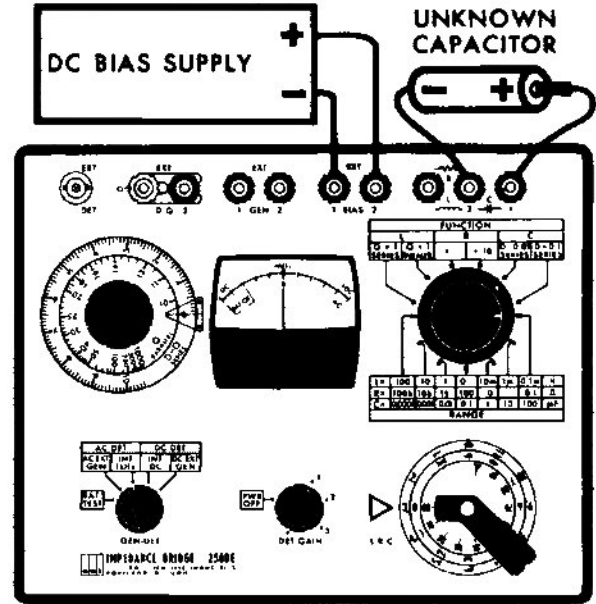
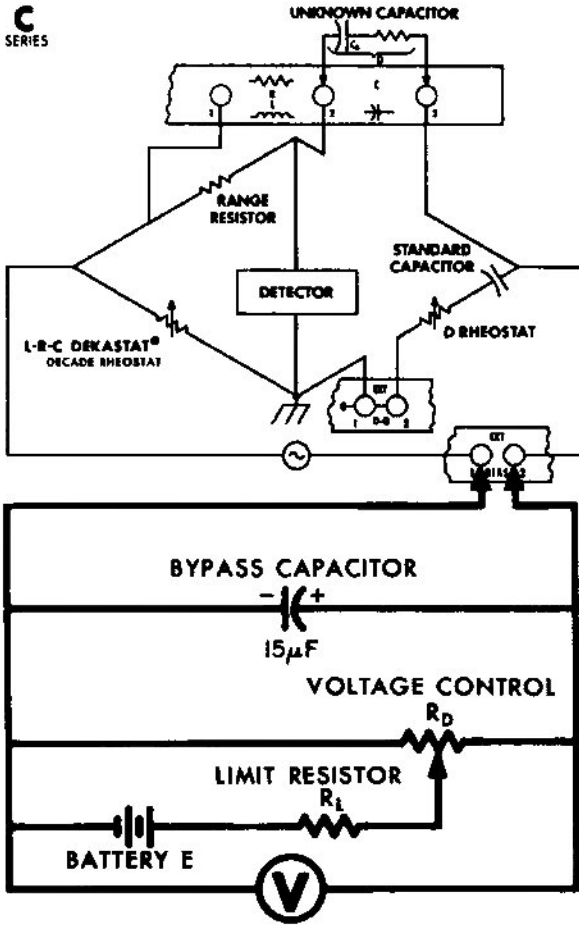

Figure 4-5. Capacitance Measurement Using DC

4.4 VOLTAGE ACROSS UNKNOWN CAPACITOR

In many cases it is necessary to measure the ac voltage across a capacitor being tested. With the following procedure, the voltage can be measured with a high-impedance ac voltmeter without loading the capacitor under test.

1. Connect grounded terminal of ac voltmeter to EXT D-Q terminal 1 and other terminal of the voltmeter to EXT BIAS terminal 2 (see Figure 4-6).
2. Balance the bridge and then read voltage on the voltmeter.

Since measuring voltage this way does not load the capacitor under test, the voltage will be correct. The capacitance reading of the bridge may be incorrect while the voltmeter is connected because the voltmeter may load the standard capacitor. For the correct capacitance reading, disconnect the voltmeter from the EXT BIAS terminal and rebalance the bridge.

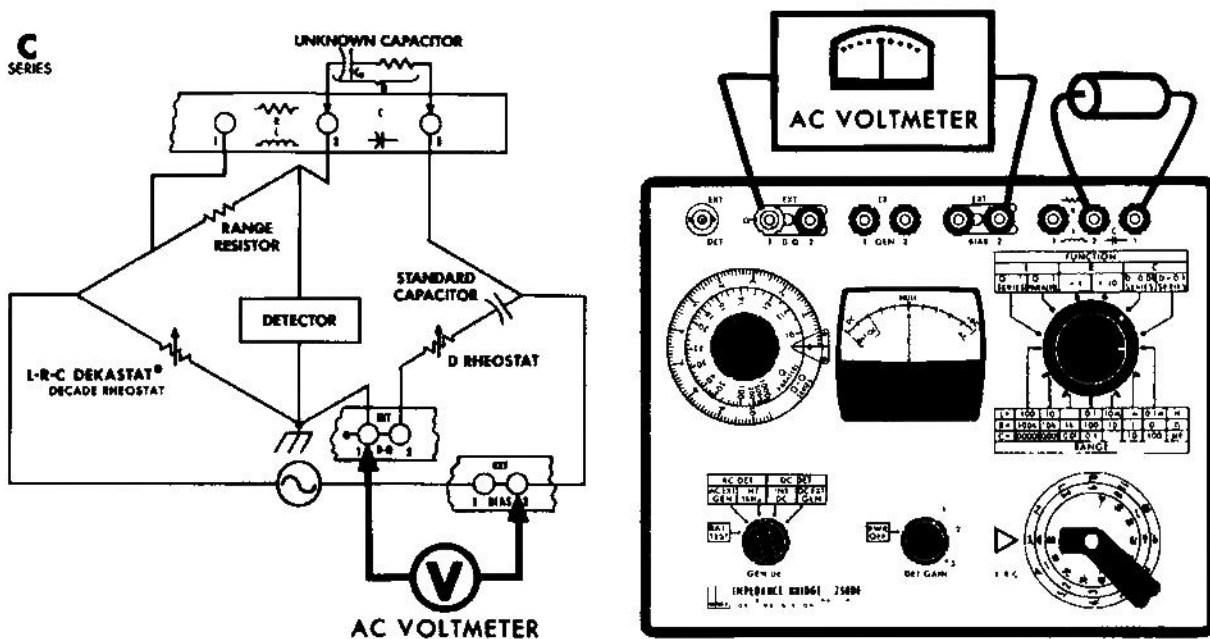

Figure 4-6. Voltage Across Unknown Capacitor

4.5 NOTES ON CAPACITANCE MEASUREMENT

4.5.1 Series and Parallel Capacitance

The bridge measures a simple equivalent circuit for the impedance connected to its terminals. This equivalent circuit consists of a capacitance and a resistance connected in series. An alternate representation of the same impedance is an equivalent circuit consisting of a different capacitance and resistance connected in parallel. The phase and magnitude of the measured impedance are identical for both circuits.

When the bridge measures series capacitance, C_s :

$$C_s = (\text{RANGE switch setting}) \times (\text{L-R-C decade dial reading})$$

$$D = (\text{FUNCTION switch setting}) \times (\text{D-Q dial reading}) \times (f_{\text{kHz}})$$

$Q = \frac{1}{D}$		R_s in kilohms
$R_s = \frac{D}{2\pi f C_s}$		f in kilohertz
$Z = \frac{D - j}{2\pi f C_s}$		C_s in microfarads
		$j = \sqrt{-1}$
		Z in kilohms

To calculate the equivalent parallel circuit:

$$C_p = \frac{C_s}{1 + D^2}$$

The D of the equivalent parallel circuit always equals the D of the equivalent series circuit. The same is true of Q .

4.5.2 Low-Capacitance Measurements

In making low-capacitance measurements, there are three things to watch out for:

1. Be careful to avoid pickup.
2. Keep the stray capacitance to a minimum.
3. Subtract the zero capacitance of the bridge from the dial reading.

To minimize the first two effects, keep hands as far as possible from the capacitor being measured. The zero capacitance of the bridge is measured with nothing connected to the C terminals; it is approximately 2 picofarads.

Keep the leads as short and direct as possible. If extended leads are necessary, the lead from terminal 2 should be shielded. (See paragraph 6.6).

4.5.3 High-Capacitance Measurements

The bridge measures the total impedance connected to its terminals. Both the unknown capacitor and its leads contribute to this impedance. The leads have some resistance and inductance which affect the value read from the bridge. For the greatest accuracy, minimize the lead impedance. Short heavy leads will reduce the resistance and closely spaced, twisted leads will reduce inductance and the pickup of stray fields.

SECTION V

INDUCTANCE MEASUREMENT

The Model 250DE Impedance Bridge measures inductance in terms of a two-element equivalent circuit consisting of an inductance either in series or in parallel with a resistance. The internal ac generator and detector of the Model 250DE Bridge are tuned to 1 kilohertz (kilocycle). Other frequencies can be used, but an external generator and detector is required. (See paragraph 6.4).

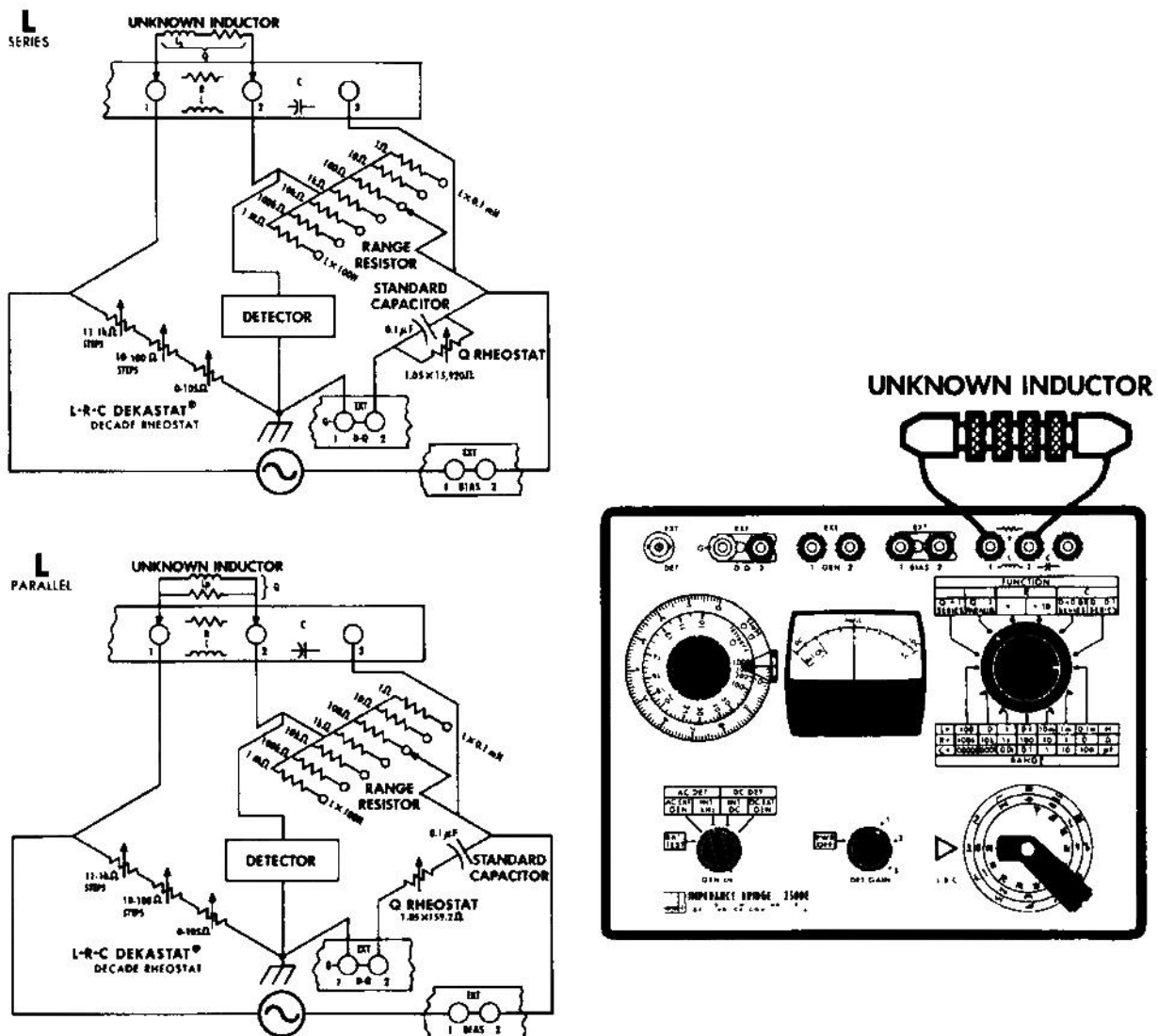

Figure 5-1. Inductance Measurement

5.1 NORMAL INDUCTANCE MEASUREMENTS

1. Turn DET GAIN control to 1. This turns on all power to the instrument.
2. Set FUNCTION switch to L, either $Q \times 1$ SERIES or $Q \times 1$ PARALLEL. Use the SERIES position for Q less than 10, the PARALLEL position for Q greater than 10.
3. Set L-R-C decade dials to 3.000 and D-Q dial to 1000 or 10.5. These settings make it easier to find the correct range.
4. Connect the unknown inductor to R-L terminals 1 and 2. Make good contact with the terminals.
5. Set GEN-DET switch to INT 1 kHz. If an external ac detector or generator is required, see paragraph 6.1 or 6.3.
6. Adjust RANGE switch for minimum detector deflection. Turn DET GAIN control clockwise to increase the sensitivity if necessary.
7. Adjust L-R-C decade dials and D-Q dial alternately for minimum meter deflection. As the null is approached, turn DET GAIN control clockwise to increase sensitivity. If there is some difficulty in balancing the bridge, especially if the Q is less than 1, it may be due to a sliding balance. See paragraph 6.5.
8. Read the measured inductance as the product of L-R-C dial setting times RANGE switch setting. If L-R-C dial reading is less than 1.200, turn RANGE control one step counterclockwise and repeat step 7 in order to take full advantage of the bridge resolution.
9. Read the measured storage factor (Q) directly from D-Q dial. Use the inner dial for L-parallel and the outer dial for L-series. If the frequency is other than 1 kilohertz (kilocycle) see paragraph 6.4.
10. Disconnect the unknown inductor and turn DET GAIN control to PWR OFF before leaving the instrument.

5.2 INDUCTANCE MEASUREMENT WITH EXTENDED Q RANGE

The D and Q ranges of the bridge can be extended by use of an external rheostat connected to terminals provided. Figure 5-2 shows the range for which this technique is advisable.

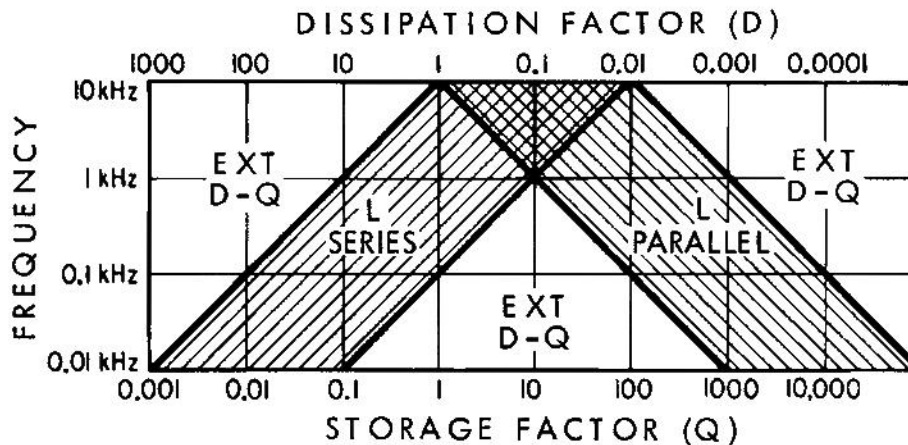

Figure 5-2. D and Q Range

5.2.1 Preliminary Procedure

The external Q rheostat can be used for either series or parallel inductance. In either case:

1. Set FUNCTION switch to L-PARALLEL. This bridge circuit gives the best result for either series or parallel inductance.
2. Turn D-Q dial to 1000 and leave it there during the measurement. This shorts out the internal D-Q rheostat, which is a tapped rheostat. To go beyond 1000 will increase the resistance.

5.2.2 Parallel Inductance

1. Remove shorting lug from between EXT D-Q binding posts. The lug may be pivoted to one side.
2. Connect an external rheostat between EXT D-Q binding posts. See Figure 5-3.
3. Balance the bridge using external rheostat instead of D-Q dial. The measured inductance is the product of the L-R-C dial setting times the setting of the RANGE control.

4. Calculate Q

$$Q = \frac{1.592}{f_k R_k}$$

Q is the storage factor.

f_k is the frequency in kilohertz (kilocycles)

R_k is the resistance in kilohms of the external Q rheostat.

$f_k = 1$ if the internal generator and detector are used.

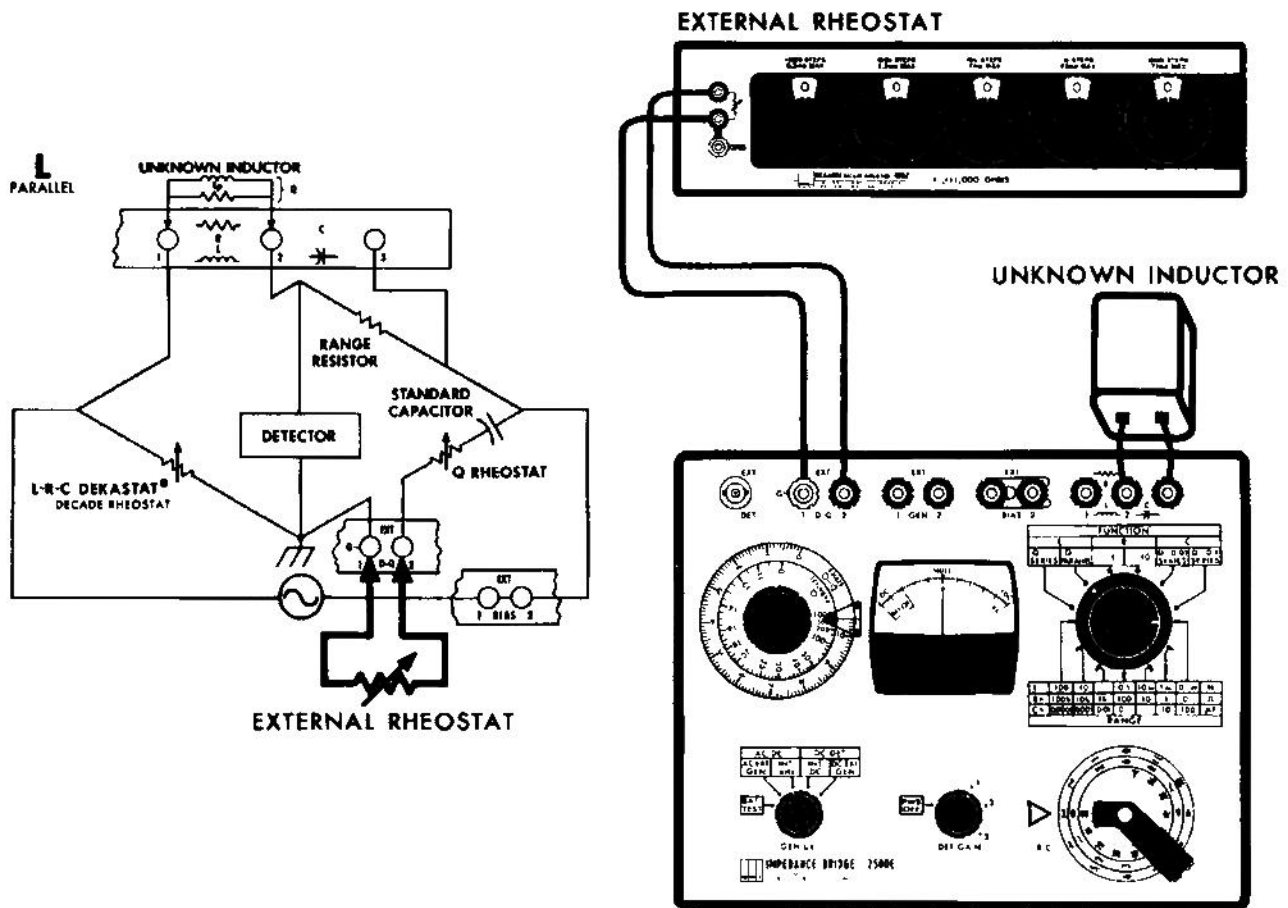

Figure 5-3. Parallel Inductance, External Q Rheostat

5.2.3 Series Inductance

1. Connect an external rheostat between C terminal 3 and EXT D-Q terminal 1.

See Figure 5-4. Be sure that the shorting lug is connected between EXT D-Q terminals.

2. Balance the bridge using external rheostat instead of D-Q dial.

3. Calculate Q.

$$Q = 0.628 f_k R_k$$

The measured inductance is the product of the L-R-C dial times the setting of the RANGE switch.

Q is the storage factor.

f_k is the frequency in kilohertz (kilocycles).

R_k is the resistance in kilohms of the external Q rheostat.

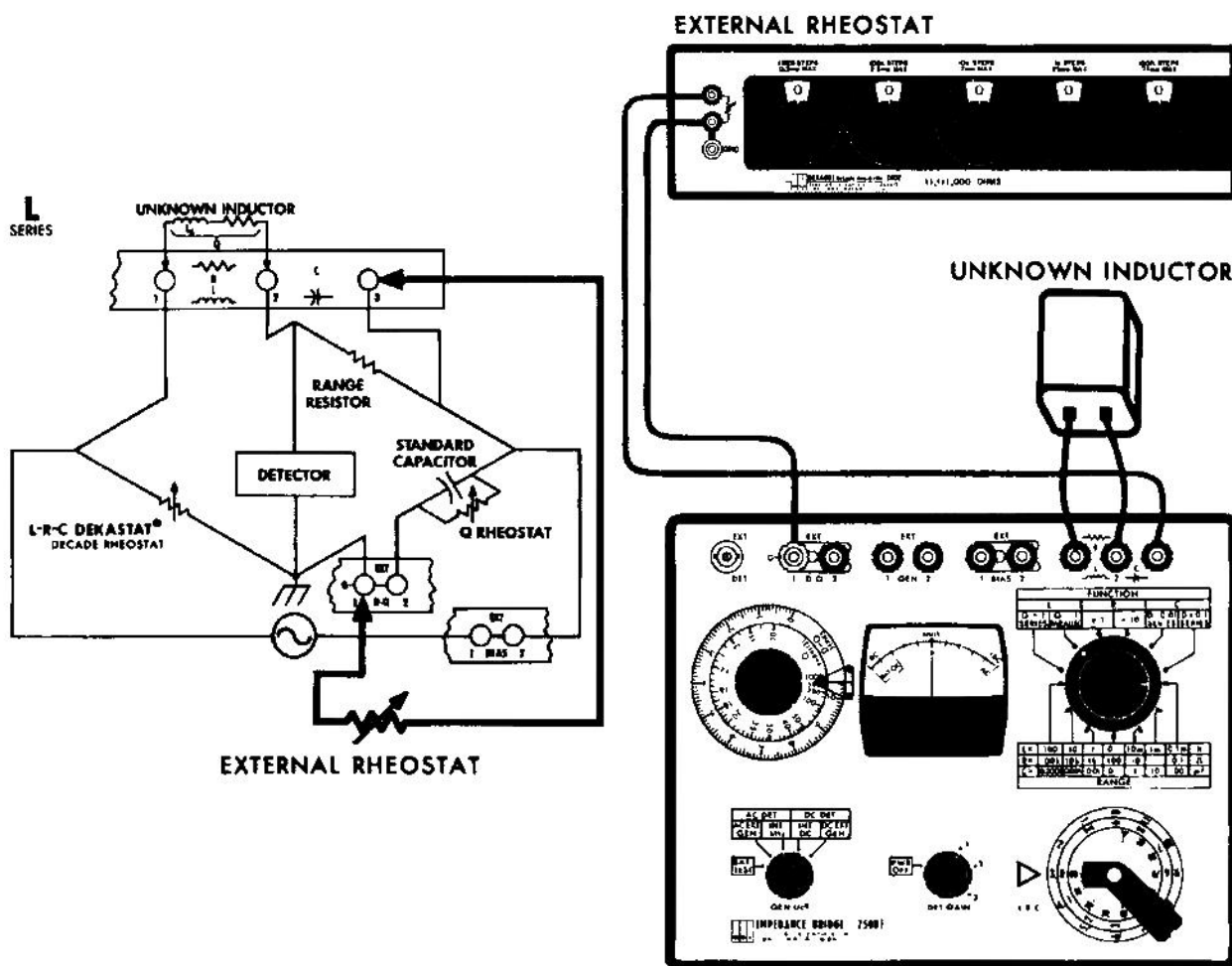

Figure 5-4. Series Inductance, External Q Rheostat

5.3 INDUCTANCE MEASUREMENT USING DC

Iron-core inductors are sensitive to both ac and dc current variations. Quantitative measurements of dc effects can be made with the Model 250DE bridge by supplying current to the unknown inductor through the EXT BIAS terminals.

5.3.1 DC Supply

The dc current should be supplied from a power-limited source in order to prevent damage to the bridge. The power to the bridge should not exceed 1 watt, and the current should not exceed 100 milliamperes during measurement. Higher current will cause distortion of the ac generator output and may result in incorrect measurements.

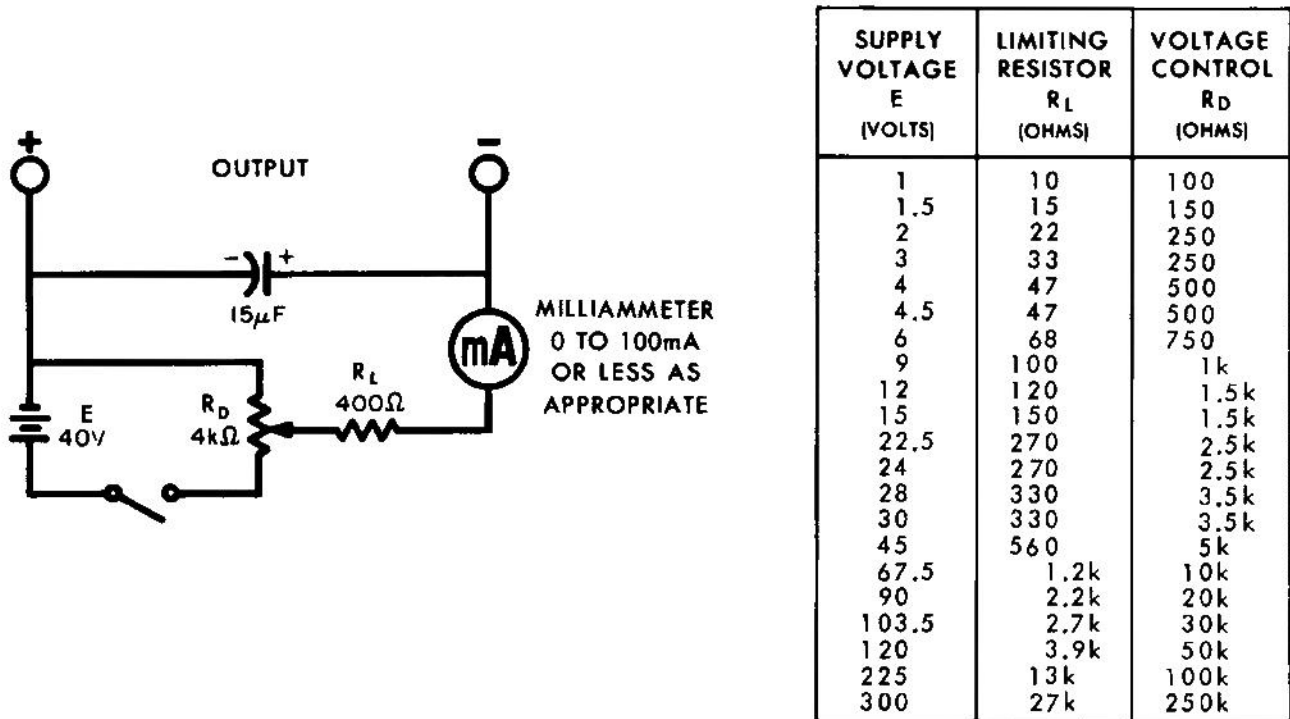

Figure 5-5. DC Supply Circuit

The dc supply circuit shown in Figure 5-5 is safe at any bridge setting. Other values of voltage, limiting resistor (R_L) and voltage control (R_D) are given in the table. These values do not necessarily limit the current to less than 100 milliamperes, but they do limit the power to 1 watt. Values shown are for commonly available voltages. The limiting resistors can have tolerances of 20% and should be rated at 5 watts or more. If the proper value of resistor is not available, use a larger value rather than smaller. The voltage control potentiometer may differ from the listed value by a factor of 2. It should be rated at 1 watt or more.

5.3.2 Operating Procedure

1. Set FUNCTION switch to L-PARALLEL or L-SERIES.

The L-PARALLEL setting is preferred since in this bridge configuration, the standard capacitor blocks dc current and allows direct measurement of current through the inductor.

2. Connect the unknown inductor to R-L terminals 1 and 2.
3. Remove shorting lug and connect dc bias between EXT BIAS terminals 1 and 2.
4. For L-PARALLEL: Adjust dc current as required and measure inductance. For L-SERIES: Set current to approximately the desired level and balance the bridge for a first approximation.
5. For L-SERIES: Connect a dc voltmeter between C terminal 3 and L-R-C terminal 2.
6. For L-SERIES: Alternately adjust the bridge for balance and adjust the current for the desired level.

See Figure 5-6.

See Figure 5-6. The shorting lug can be pivoted to one side.

See paragraph 5.1 for normal procedure. The L-PARALLEL configuration allows direct measurement of current in the inductor.

Be sure to use a high-impedance voltmeter that is well isolated from the chassis of the Model 250DE Bridge. See Figure 5-6.

The current in milliamperes is equal to the measured voltage times a factor that depends on the RANGE switch setting. The following table lists the multipliers.

RANGE SETTING	MULTIPLIER
0.1 mH	1000
1 mH	100
10 mH	10
0.1 H	1.0
1 H	0.1
10 H	0.01
100 H	0.001

7. For L-SERIES: When the correct current is flowing at the same time the bridge is balanced, disconnect the voltmeter and rebalance the bridge.

The indicated current is correct, but there may be an error in measured inductance when the voltmeter is connected because it may load the range resistor.

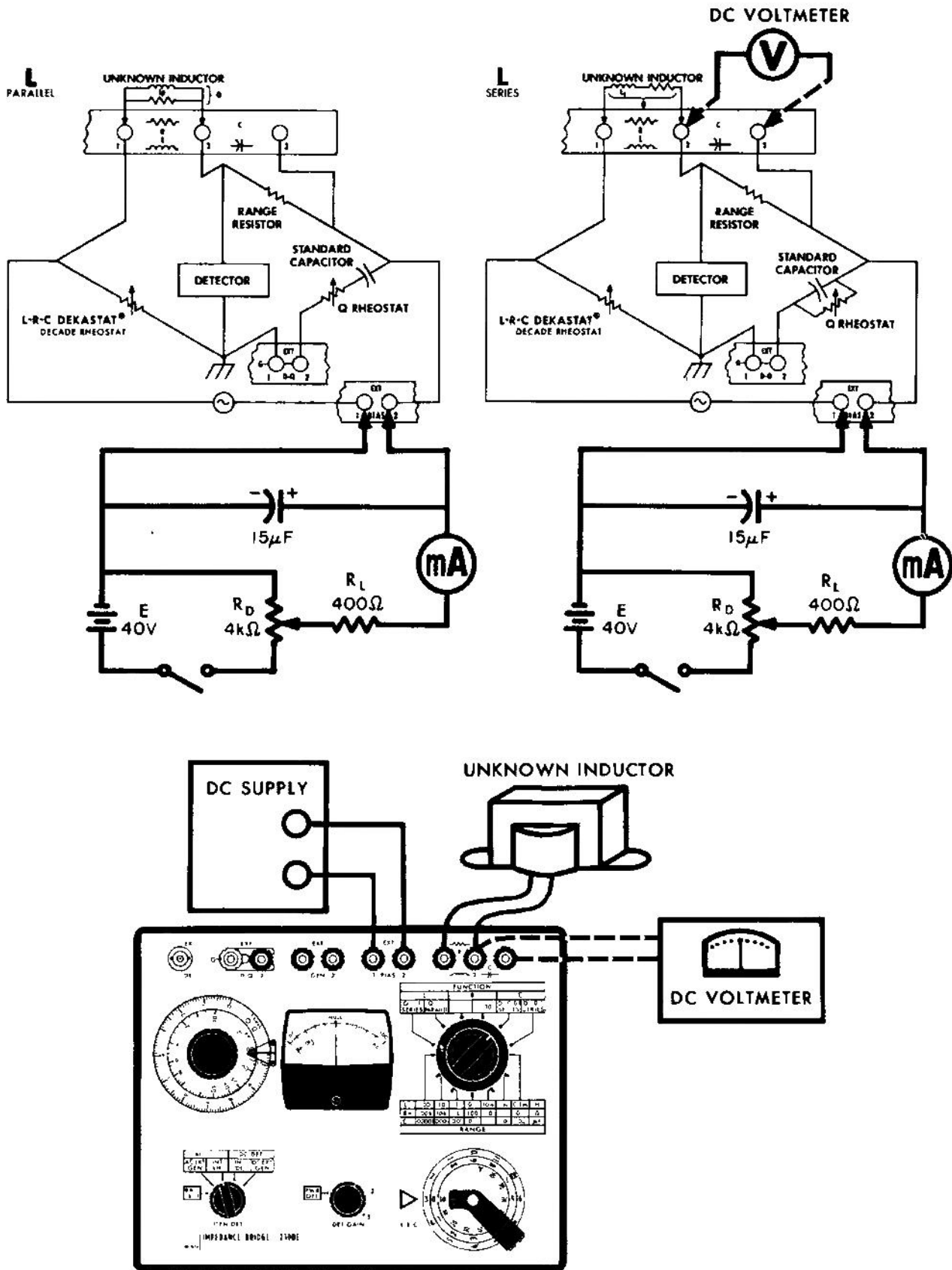

Figure 5-6. Inductance Measurement Using DC

5.4 VOLTAGE AND CURRENT IN UNKNOWN INDUCTOR

In many cases it is necessary to measure the ac voltage or current in an inductor being tested. Either can be measured with a high-impedance ac voltmeter.

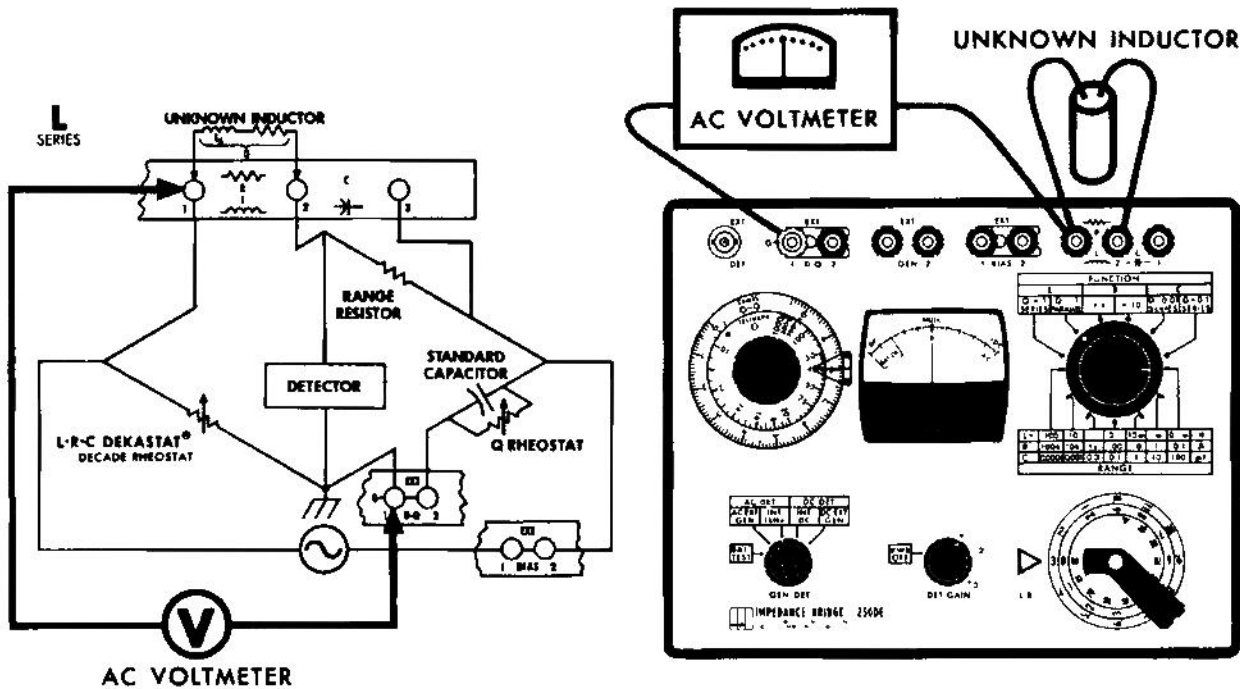

Figure 5-7. Voltage Measurement

5.4.1 Voltage

To measure ac voltage across an inductor being tested:

1. Connect the ground terminal of the voltmeter to EXT D-Q terminal 1 and the other voltmeter terminal to R-L terminal 1 (see Figure 5-7).
2. Balance the bridge and then read the voltage on the voltmeter.

Since measuring voltage in this way does not load the inductor, the voltage reading will be correct. The inductance reading of the bridge may be incorrect because the voltmeter may load the L-R-C decades. For the correct inductance measurement, disconnect the voltmeter from the L terminal and rebalance the bridge.

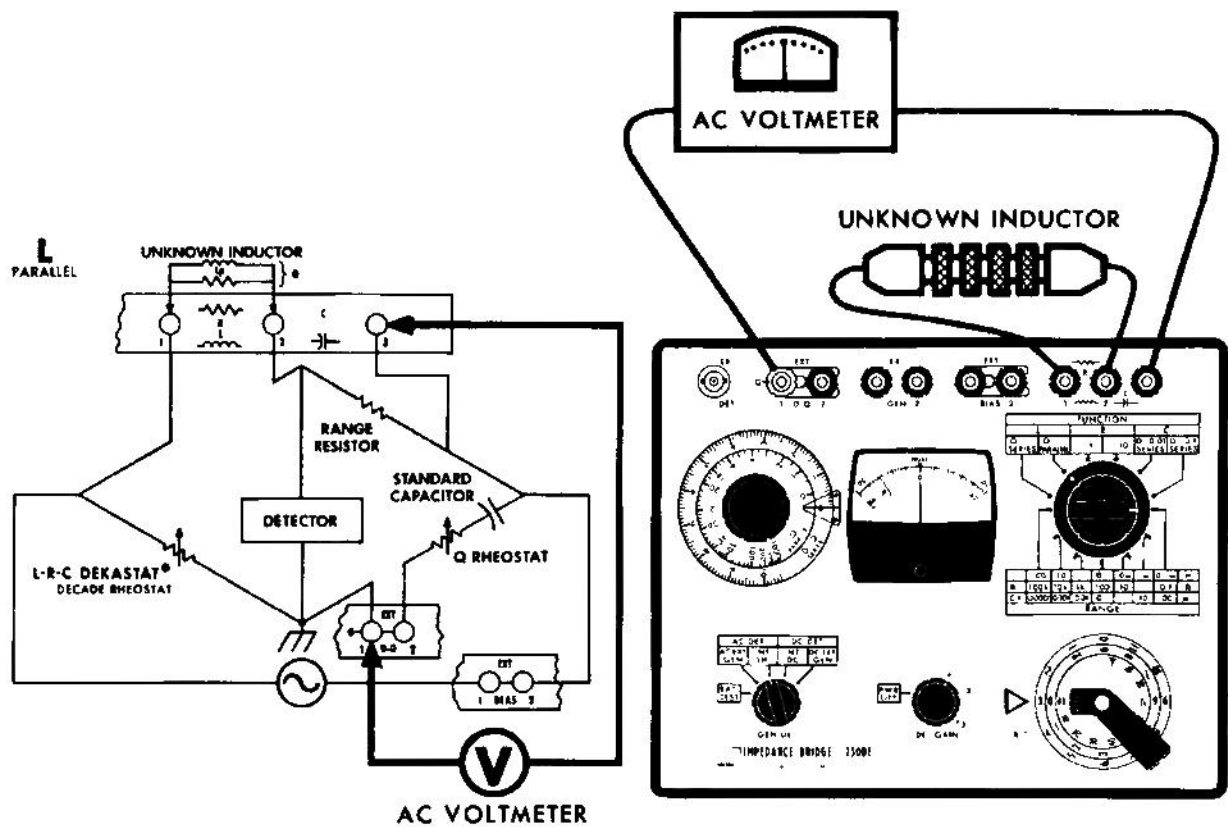

Figure 5-8. Current Measurement

5.4.2 Current

To measure ac current in an inductor being tested:

1. Connect the ground terminal of the voltmeter to EXT D-Q terminal 1 and the other voltmeter terminal to C terminal 3 (see Figure 5-8).
2. Balance the bridge and then read the voltage.
3. The current in milliamperes is equal to the measured voltage multiplied by a factor that depends on the RANGE switch setting.

RANGE SETTING	MULTIPLIER
0.1 mH	1000
1 mH	100
10 mH	10
0.1 H	1.0
1 H	0.1
10 H	0.01
100 H	0.001

The current in milliamperes is correct, but since the voltmeter may load the standard capacitor, the measured inductance may be incorrect when the voltmeter is connected.

5.5 NOTES ON INDUCTANCE MEASUREMENT

5.5.1 Series and Parallel Inductance

The bridge measures a simple equivalent circuit for the impedance connected to its terminals. This equivalent circuit consists of either an inductance and resistance connected in series or a different inductance and resistance connected in parallel. The phase and magnitude of the resulting impedance are identical for both circuits. For values of Q less than 100 the series and parallel inductances differ measurably.

When the bridge measures series inductance, L_s :

$$L_s = (\text{RANGE switch setting}) \times (\text{L-R-C dial reading})$$

$$Q = (\text{Outer D-Q dial reading}) \times (f_{\text{kHz}})$$

$$D = \frac{1}{Q} \left| \begin{array}{l} R_s \text{ in kilohms} \\ f \text{ in kilohertz} \\ L_s \text{ in henrys} \end{array} \right.$$

$$R_s = \frac{2\pi f L_s}{Q}$$

$$Z = 2\pi f L_s \left(\frac{1}{Q} + j \right) \left| \begin{array}{l} i = \sqrt{-1} \\ Z \text{ in kilohms} \end{array} \right.$$

To calculate the equivalent parallel circuit:

$$L_p = \left(1 + \frac{1}{Q^2} \right) L_s$$

$$R_p = Q (2\pi f L_p)$$

The Q of the equivalent parallel circuit always equals the Q of the equivalent series circuit. The same is true of D.

When the bridge measures parallel inductance, L_p :

$$L_p = (\text{RANGE switch setting}) \times (\text{L-R-C dial reading})$$

$$Q = (\text{Inner D-Q dial reading} \div (f_{\text{kHz}}))$$

$$D = \frac{1}{Q} \left| \begin{array}{l} R_p \text{ in kilohms} \\ f \text{ in kilohertz} \\ L_p \text{ in henrys} \end{array} \right.$$

$$R_p = 2\pi f L_p Q$$

$$Z = \frac{2\pi f L_p Q (1 + jQ)}{1 + Q^2} \left| \begin{array}{l} i = \sqrt{-1} \\ Z \text{ in kilohms} \end{array} \right.$$

To calculate the equivalent series circuit:

$$L_s = \left(\frac{Q^2}{1 + Q^2} \right) L_p$$

$$R_s = \frac{2\pi f L_s}{Q}$$

The Q of the equivalent series circuit always equals the Q of the equivalent parallel circuit. The same is true of D.

5.5.2 Low -Inductance Measurements

The bridge measures the total impedance connected to its terminals. Both the unknown inductor and its leads contribute to this impedance. The leads have some resistance and inductance which affect the value read from the bridge.

For greatest accuracy, minimize the lead impedance. Short heavy leads will reduce the resistance and closely spaced, twisted leads will reduce the inductance and the pickup of stray fields.

5.5.3 High-Inductance Measurements

In making high-inductance measurements, there are two things to watch out for:

1. Be careful to avoid ac pickup.
2. Keep the stray capacitance to a minimum.

To minimize both effects keep hands as far as possible from the inductor measured. Keep the leads as short and direct as possible. If extended leads are necessary, the lead from terminal 2 should be shielded. See paragraph 6.6. Take care to avoid coupling stray magnetic fields into the inductor being measured.

SECTION VI

USEFUL MEASUREMENT TECHNIQUES

6.1 EXTERNAL DETECTOR

The Model 250DE has provision for connecting an external detector such as an ac or dc microvoltmeter, a galvanometer, or an oscilloscope. The external detector can best be connected to the EXT DET socket which is a BNC coaxial connector as shown in Figure 6-1. Note that the GEN-DET switch does not disconnect the EXT DET connector from the bridge circuit. This allows the internal detector to be used at the same time as the external.

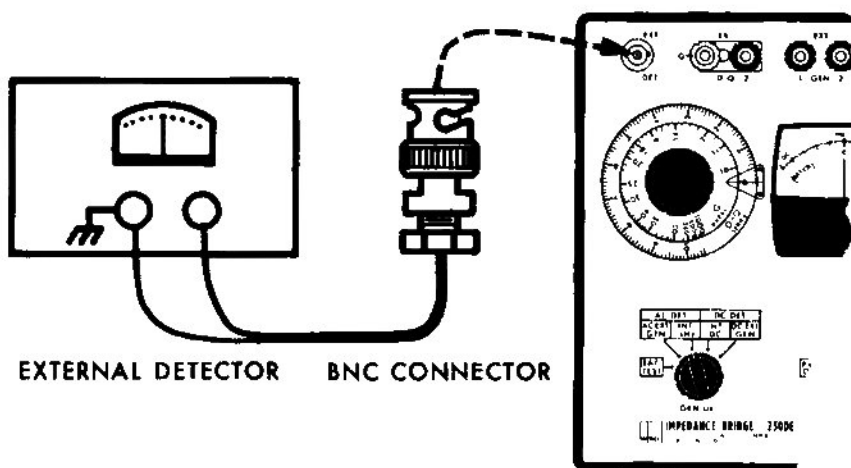

Figure 6-1. External Detector Connection

6.2 EXTERNAL DC GENERATOR

An external dc generator may be connected to the bridge between EXT GEN terminals 1 and 2 as shown in Figure 6-2. Set the GEN-DET switch to DC EXT GEN to connect the external generator to the bridge and to disconnect the isolation transformer from the circuit.

Always use a power-limited dc source. The power in the circuit shown is limited by a resistor R_L . If the value of the resistor is chosen from the accompanying table, the power in the bridge will never exceed one watt, which is always safe. Values shown are for commonly-available voltages. The limiting resistors can have tolerances of 10 or 20 percent, and should be rated at five watts or more. If the proper value of resistance is not available, use a larger value rather than a smaller.

If a supply voltage much different from those listed is to be used, use the following formula to determine the proper value of limiting resistance:

$$R_L = \frac{E^2}{4}$$

Batteries are recommended because many line-operated power supplies have objectionably high leakage to ground. If a line operated supply is to be used, be sure that its insulation resistance to the chassis of the Model 250DE is higher than 10^{10} ohms.

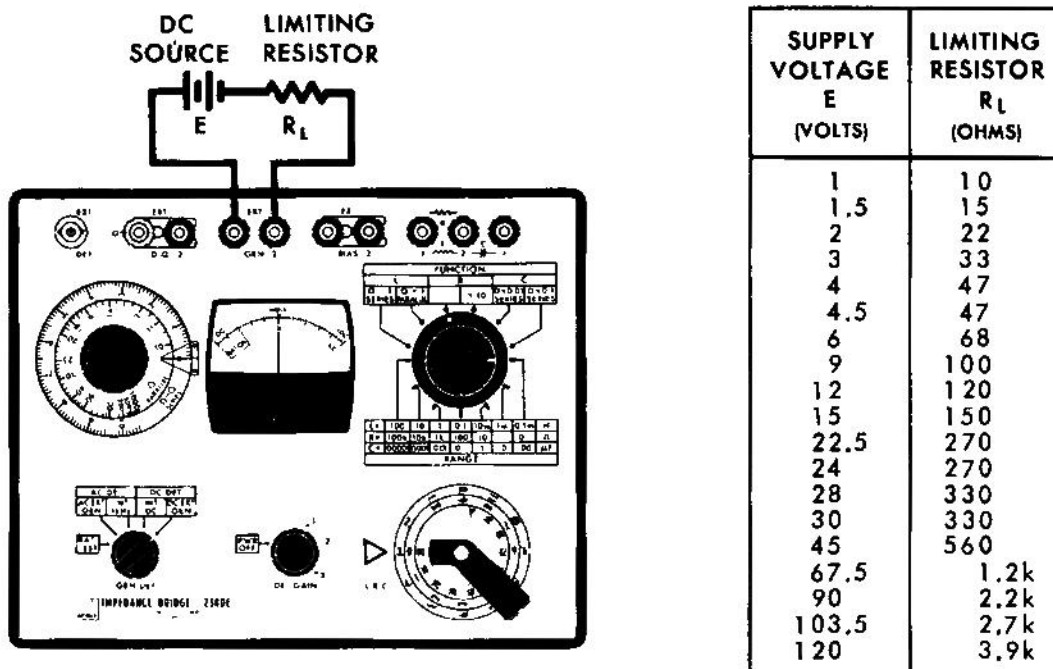

Figure 6-2. External DC Generator

See also paragraphs 4.3 and 5.3 for external dc supplies used in conjunction with ac measurements. The dc supplies, especially that of paragraph 4.3 are useful for dc resistance measurement.

6.4 OPERATION AT FREQUENCIES OTHER THAN ONE KILOHERTZ (KILOCYCLE)

In order to operate the Model 250DE Impedance Bridge at frequencies other than 1 kilohertz, an external ac generator and detector are required. It goes without saying that the generator and detector must be tuned to the same frequency.

There are two effects that must be taken into consideration at frequencies other than 1 kilohertz:

1. The dissipation factor (D) and the storage factor (Q) cannot be read directly from the D-Q dial.
2. The specified accuracy of the bridge changes as a function of frequency.

6.4.1 D and Q Corrections

To find the dissipation factor (D) of a capacitor, multiply the D-Q dial setting times the FUNCTION switch setting times the frequency in kilohertz.

To find the storage factor (Q) of an inductor, multiply the outer D-Q dial reading by the frequency in kilohertz, or divide the inner Q dial reading by the frequency in kilohertz. Use the outer dial for series inductors and the inner dial for parallel inductors, exactly as in normal inductance measurements.

6.4.2 Accuracy

Accuracy of capacitive and inductive measurements and of D and Q measurements as functions of frequency are shown in the following table. At one kilohertz, the frequency multiplier is unity and the accuracy is as specified in paragraph 1.2.

ACCURACY		
RANGE	MAGNITUDE	D OR Q
HIGHEST	$0.3\% + 1 \text{ DIAL DIV} + 4.0\% \times f_{\text{kHz}}/Q$	$0.040 f_{\text{kHz}}(1+Q^2) + 0.02Q$
OTHER 5	$0.3\% + 1 \text{ DIAL DIV} + 0.5\% \times f_{\text{kHz}}/Q$	$0.005 f_{\text{kHz}}(1+Q^2) + 0.02Q$
LOWEST	$0.3\% + 1 \text{ DIAL DIV} + 4.0\% \times f_{\text{kHz}}/Q$	$0.040 f_{\text{kHz}}(1+Q^2) + 0.02Q$
HIGHEST	$0.3\% + 1 \text{ DIAL DIV} + 4.0\% \times f_{\text{kHz}}/Q$	$0.040 f_{\text{kHz}}(1+D^2) + 0.02Q$
OTHER 5	$0.3\% + 1 \text{ DIAL DIV} + 0.5\% \times f_{\text{kHz}}/Q$	$0.005 f_{\text{kHz}}(1+D^2) + 0.02Q$
LOWEST	$0.3\% + 1 \text{ DIAL DIV} + 4.0\% \times f_{\text{kHz}}/Q$	$0.040 f_{\text{kHz}}(1+D^2) + 0.02Q$
HIGHEST	$0.2\% + 1 \text{ DIAL DIV} + 4.0\% \times D \times f_{\text{kHz}}$	$0.040 f_{\text{kHz}}(1+D^2) + 0.02D$
OTHER 5	$0.2\% + 1 \text{ DIAL DIV} + 0.5\% \times D \times f_{\text{kHz}}$	$0.005 f_{\text{kHz}}(1+D^2) + 0.02D$
LOWEST	$0.2\% + 1 \text{ DIAL DIV} + 4.0\% \times D \times f_{\text{kHz}}$	$0.040 f_{\text{kHz}}(1+D^2) + 0.02D$

6.3 EXTERNAL AC GENERATOR

The Model 250DE Impedance Bridge has terminals for connecting an external ac generator. The EXT GEN terminals are connected to the primary winding of an isolation transformer when the GEN-DET switch is in the AC EXT GEN position. Because of this, the external generator may be grounded at EXT GEN terminal 1 without causing ground loops or measurement errors.

The input voltage should be limited to 50 volts or 50 times the generator frequency in kilocycles, whichever is less. Higher voltages will saturate the isolation transformer and will be distorted. A few examples are shown in the following table:

FREQUENCY	MAXIMUM VOLTAGE
50 Hz	2.5V
60 Hz	3.0V
100 Hz	5.0V
400 Hz	20.0V
1 kHz	50.0V
above 1 kHz	50.0V

The input power should be limited to one watt. This can be done easily by inserting a resistor in series with the generator (see Figure 6-3). The resistors listed can have tolerances of 10 or 20 percent, and should be rated at 5 watts or more. If the proper value of resistance is not available, use a larger value rather than a smaller.

If a supply voltage much different than those listed is to be used, calculate the value of limiting resistor from the formula:

$$R_L = \frac{E^2}{4}$$

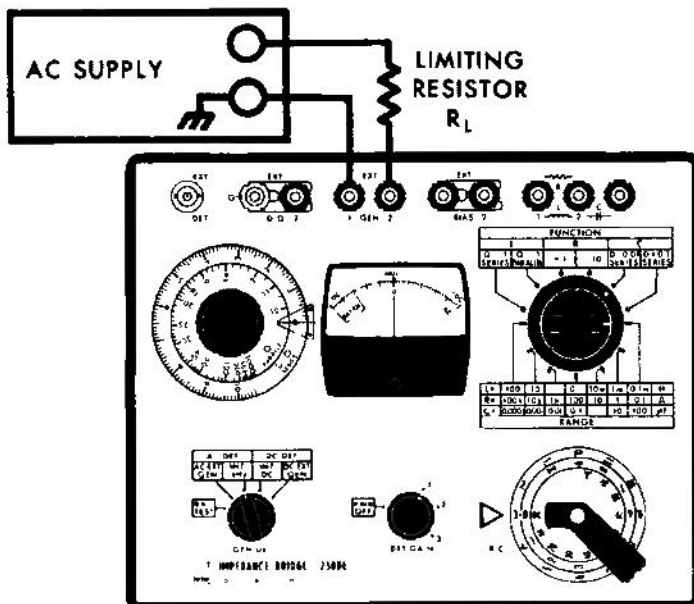

SUPPLY VOLTAGE E (VOLTS)	LIMITING RESISTOR R _L (OHMS)
1	0.27
2	1.0
5	6.8
10	27
20	100
50	680

Figure 6-3. External AC Generator

6.5 SLIDING BALANCE

When lossy capacitors and inductors are measured, the nulling problem known as sliding balance can occur. This problem is most frequently encountered in inductors. It is not too serious if the Q of an inductor is greater than 1 or if the D of a capacitor is less than 1. In either case, an external D - Q rheostat may be necessary.

The problem becomes apparent when the instrument seems to have false nulls at different settings of the R - L - C decade dials and the D - Q dial. Figure 6-4 illustrates the cause of the difficulty.

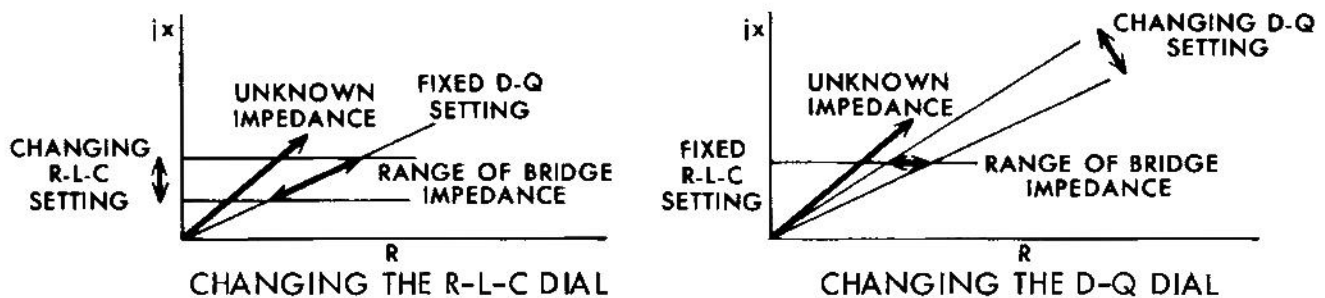

Figure 6-4. Sliding Balance

If the unknown impedance and the bridge impedance are considered as vectors, the bridge is balanced when the vectors are equal. The L - R - C decade dials change the vector of the bridge impedance only along the R axis, and the D - Q dial changes the angle of the vector of the bridge impedance. If the angle of the unknown impedance vector is not steep, the L - R - C decades and the D - Q dial operate nearly perpendicular to each other and there is little or no difficulty. (This is the case of low D or High Q .)

If the D of a capacitor is high or the Q of an inductor is low, the vector of the unknown impedance has such a steep angle that the dials no longer move the bridge impedance vector directly to a null.

The following technique will allow rapid and accurate measurements with sliding balance.

1. Make a preliminary measurement using the techniques described in paragraph 4.1 for capacitors, paragraph 5.1 for inductors. This gives a first approximation. The null at this point may not be very sharp.
2. Adjust DET GAIN control so that meter pointer is on third long mark to right of 0. This sets a reference level on the detector. As the null comes closer, use marks closer to 0.
3. Turn the inner L - R - C dial a small amount in one direction, then adjust D - Q dial for minimum detector deflection. Turn one switch step of the outer dial at first. Use smaller steps when the null is close.

4. Note the reading on the meter. If it is closer to 0, repeat steps 2 and 3, turning L-R-C dial in the same direction. If the reading is further from 0, repeat steps 2 and 3, turning L-R-C dial in the opposite direction.

5. When the null is close, turn the D-Q dial part; of a dial division at a time and adjust L-R-C dial for best null.

This procedure should converge to a sharp null. Each step should be shorter than the last when the null is close.

Watch out for false nulls at the ends of the range of the instrument, especially at low settings of the series inductive circuit. When the D-Q dial and the L-R-C dials are both at zero in the series inductive circuits, the generator is short circuited and the bridge indicates null.

6.6 EXTENDED LEADS WITH AC MEASUREMENTS

Sometimes it is necessary to use extended leads when making ac measurements. This can be done without causing significant errors in the measurements.

1. Connect a shielded lead to L-R-C terminal 2.
2. Connect the shield for this lead to EXT D-Q terminal 1 (ground).
3. Connect an unshielded lead to C terminal 3 for capacitive measurements, to L-R terminal 1 for inductive measurements.
4. Connect the capacitance or inductance to be measured between the shielded and unshielded lead.

When the leads are connected in this manner, the capacitance between the shielded lead and the shield is across the detector, and will not cause errors in measurement. In the capacitance-measuring circuit, the stray capacitance from the unshielded lead to ground is across the 100-nF standard capacitor, and will not cause significant errors unless it is more than 10 pF. In the inductance-measuring circuit, the stray capacitance of the unshielded lead is across the L-R-C decade rheostat, and will cause no significant errors if it is less than 1 pF. If the L-R-C decade setting is less than 1.0, 10-pF stray capacitance will cause no significant error.

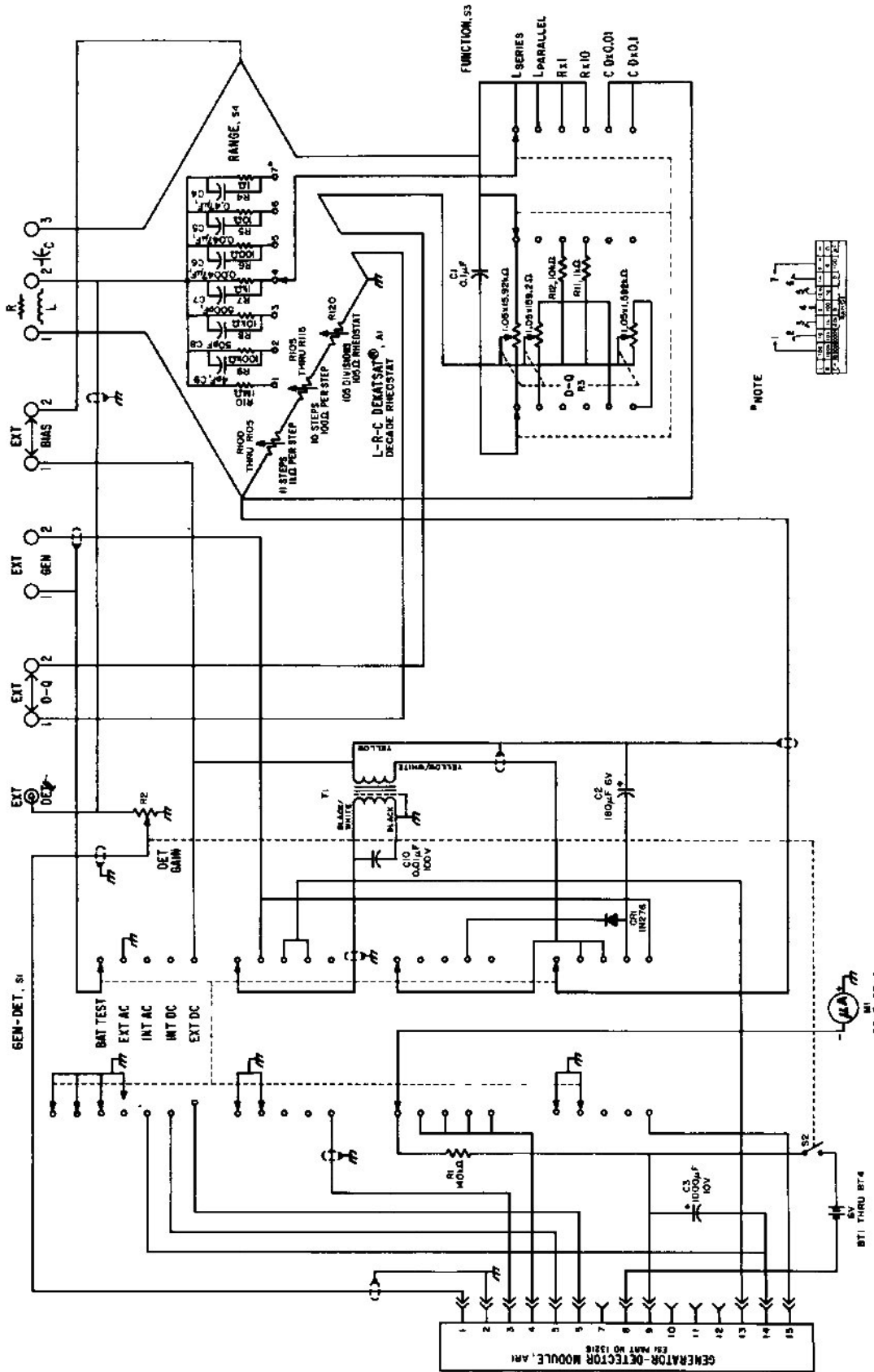

Figure 6-5. Model 250DE Schematic Diagram

SECTION VII

REPLACEMENT PARTS

The following parts are listed alphabetically by description of part or major assembly. Parts of each major assembly are indented and listed alphabetically within each grouping. All parts are available from Electro Scientific Industries, Inc.

The Federal Supply Code for Manufacturers (FSC) for Electro Scientific Industries is 11837.

When ordering parts, please include the following information:

Model and Serial number of the instrument
ESI part number
Description of part

<u>DESCRIPTION</u>	<u>PART NO.</u>	<u>QTY USED</u>	<u>CKT REF</u>
Battery, 1.5V, "D" Cell	5267	4	BT1 thru 4
Battery Clip, 4 Cell	6589	1	
Binding Post	1393	9	
Bushing, L-R-C Index Supporting	73016	1	
Cap, Binding Post, Black	1170	8	
Cap, Binding Post, Gold Plated	1172	1	
Capacitor, 0.01 μ F, 100V	6469	1	C10
Capacitor, 180 μ F, 6V	6474	1	C2
Capacitor, 1000 μ F, 10V	13317	1	C3
Capacitor Assembly, Standard With Trimmer	4197	1	C1
Case	13251	1	
Connector, Coaxial	13255	1	
DEKASTAT [®] Decade Rheostat Assembly, L-R-C	13248	1	A1
- including -			
Dial, 0-X	4775	1	
Dial, 0-11	75292	1	
Dial, Rheostat	4970	1	
Resistor, 100 Ω	4890	1	R100
Resistor, 200 Ω	4889	5	R101 thru 105
Resistor, 1k Ω	4884	1	R110
Resistor, 2k Ω	4883	5	R111 thru 115
Rheostat Assembly, 105 Ω	4969	1	R120
Dial, D-Q	13197	1	
Dial, FUNCTION	4880	1	
Diode, 1N 276	13287	1	CR1
Generator-Detector Printed Circuit Board Assembly	13216	7	AR1
Index, D-Q	13196	1	
Index, L-R-C	73019	1	
Instruction Manual	13202	1	
Instruction Sheet, Short Form	13204	1	
Knob, D-Q	1271	1	
Knob, Large Bar, Filled	1266	1	
Knob, Small Bar, Filled	1270	1	

<u>DESCRIPTION</u>	<u>PART NO.</u>	<u>QTY USED</u>	<u>CKT REF</u>
Knob, Small Round, Filled	1268	1	
Lid, Less Short Form Instructions	13252	1	
Meter	13194	1	M1
Panel, Front	13206	1	
Plug, Unshielded Cable Type	13279	1	
Potentiometer-Switch, 1M Ω , DET GAIN	13253	1	R2
Resistor, 140k Ω , 1/2 Watt, 1%	1631	1	R1
Swing Lug	3247	2	
Switch Assembly FUNCTION and RANGE - including -	13250	1	
Capacitor, 4pF, 10%	2126	1	C9
Capacitor, 50pF, 5%	2132	1	C8
Capacitor, 500pF, 5%	2147	1	C7
Capacitor, 0.0047 μ F, 10%	13299	1	C6
Capacitor, 0.047 μ F, 10%	1776	1	C5
Capacitor, 0.47 μ F, 10%	13238	1	C4
Resistor, 1 Ω , N I Type	13296	1	R4
Resistor, 10 Ω , N I Type	13297	1	R5
Resistor, 100 Ω	13261	1	R6
Resistor, 1k Ω	13274	2	R7, R11
Resistor, 10k Ω	13276	2	R8, R12
Resistor, 100k Ω	13298	1	R9
Resistor, 1M Ω	2001	1	R10
Switch Section, Dummy	2221	1	
Switch Section, RANGE	13256	1	S4
Switch Section, FUNCTION	13257	1	S3
Switch, GEN-DET	13207	1	S2
Test Lead, Black	4160	1	
Test Lead, Red	4148	1	
Transformer	13273	1	T1
Triple Rheostat Assembly, D-Q	13249	1	R3
Washer, Binding Post, Insulating	8823	8	



Electro Scientific Industries Inc

13900 N W SCIENCE PARK DRIVE
PORTLAND OREGON 97229
(area code 503) 646 4141
cable address: ESI ACTION

WARRANTY OF TRACEABILITY

THE REFERENCE STANDARDS OF MEASUREMENT OF ELECTRO SCIENTIFIC INDUSTRIES INC. ARE COMPARED WITH THE U.S. NATIONAL STANDARDS THROUGH FREQUENT TESTS BY THE U.S. NATIONAL BUREAU OF STANDARDS

THE ESI WORKING STANDARDS AND TESTING APPARATUS USED ARE CALIBRATED AGAINST THE REFERENCE STANDARDS IN A RIGOROUSLY MAINTAINED PROGRAM OF MEASUREMENT CONTROL.

THE MANUFACTURE AND FINAL CALIBRATION OF THIS INSTRUMENT WERE CONTROLLED BY THE USE OF THE ESI REFERENCE AND WORKING STANDARDS AND TESTING APPARATUS IN ACCORDANCE WITH ESTABLISHED PROCEDURES AND WITH DOCUMENTED RESULTS. (REFERENCE MIL-C-45662)



Electro Scientific Industries, Inc.

13900 N W SCIENCE PARK DRIVE
PORTLAND, OREGON 97229
(area code 503) 646 414 * telex 036 600
cable address ESIATION

WARRANTY OF QUALITY

ELECTRO SCIENTIFIC INDUSTRIES, INC. WARRANTS ITS PRODUCTS TO BE
FREE FROM DEFECTS IN MATERIAL AND WORKMANSHIP FOR A PERIOD
OF TWO YEARS FROM THE DATE OF SHIPMENT TO THE ORIGINAL
PURCHASER. WE WILL SERVICE OR, AT OUR OPTION, REPLACE ANY
DEVICE WHICH FAILS IN NORMAL USE TO MEET ITS PUBLISHED
SPECIFICATIONS

BATTERIES AND TUBES WHICH HAVE GIVEN NORMAL
SERVICE ARE EXCEPTED.

Would you like more information?



There is a complete bibliography of ESI technical publications on the opposite side of this page. Underline the titles or order numbers of any publications you would like us to send. If there is any information that you would like to have, or if there is any comment you would like to make concerning the instrument or instruction manual, please fill out this page.

Instrument Description: Model No. _____ Serial No. _____
(Please Print)

Name _____ Title _____

Dept _____ Mail Stop _____

Company _____

Address _____

City _____ State _____ Zip Code _____

Any comments or corrections? _____

Mail this page to:



Electro Scientific Industries, Inc.
13900 N. W. Science Park Drive
Portland, Oregon 97229

Attn: Technical Services Dept

- applications data
- technical articles and reports
- engineering bulletins

	Order No
Accuracy of Series and Parallel Connections of Four-Terminal Resistors, Jack C Riley, Presented at IEEE International Convention, March 1965	TA-6
AC Measurements Using Ratio Techniques, Jack C Riley, Reprinted from <i>ISA Journal</i> March 1965	TA-8
Audio-Visual Application to Equipment Calibration, Jack C. Riley and Lawrence H White, Presented at National Conference of Standards Laboratories, August 1962	EB-33
Bridge Performance Graphs, <i>ESI Design Ideas</i> , November 1961	DI-4
Calibration of a Decade Transformer, N E Morrison, Presented at AIEE Summer and Pacific General Meeting, June 1959 (revised April 1960)	EB-20
Calibration of a Kelvin-Varley Voltage Divider, Dr Merle L Morgan and Jack C Riley, Presented at Conference on Standards and Electronic Measurements, June 1960	EB-24
DC and Low Frequency AC Ratio Measurements, Dr Merle L Morgan, Presented to Study Group on Standards of Electrical Measurement, AIEE Instrumentation Division, April 1962 (revised September 1962)	EB-29
DC Measurements Using Ratio Techniques, Jack C Riley, September 1965	EB-44
Derivation of Electrical Units From Fundamental Standards, R D Kuykendall and R M Pailthorp, July 1964	EB-41
Design of a Contemporary Direct Reading Double Ratio Set and Auxiliary Lead Compensator, Marion L Roberts, Presented at IEEE International Convention, March 1965	TA-7
Determining Effective Junction Area of Diodes, February 1960 (revised)	EB-8
Four- and Three-Terminal Resistance Measurement, Jack C Riley, Reprinted from <i>Instruments and Control Systems</i> , January 1961	TA-3
High Frequency Accuracy of 250 and 290A, December 1960 (revised)	EB-17
Improved Technique for Establishing Resistance Ratios, R M. Pailthorp and Jack C Riley, Presented at Instrument-Automation Conference, Instrument Society of America, October 1962	EB-35
International System of Units and Convenient Audio Frequency Units, August 1964 (revised)	EB-26
Low Input Resistance Voltage Dividers, March 1960 (revised)	EB-15
Measuring Three-Terminal Capacitors, March 1962 (revised)	EB-7
Metrology Seminar Resistance Standards, Voltage Standards, Capacitance Standards, and Ratio Techniques, J L Thomas, George D Vincent, Robert D. Cutkosky, and Jack C Riley, Presented at WESCON Industrial Seminar, September 1964	EB-43
New Approach to Bridge Sensitivity, Jack C Riley, Presented at Instrument-Automation Conference, Instrument Society of America, January 1961 (revised November 1962)	EB-23
Precision Resistance Measurement—Part I, <i>ESI Design Ideas</i> , April 1960	DI-2
Precision Resistance Measurement—Part II, <i>ESI Design Ideas</i> , November 1960	DI-3
Ratio Transformer Bridge for Standardization of Inductors and Capacitors, D L Hillhouse and H W Kline, Presented at Conference on Standards and Electronic Measurement, June 1960	TA-2
Resistance Transfer Technique, Lawrence H. White, Presented at National Conference of Standards Laboratories Workshop June 1963 (revised July 1963)	EB-34
Sliding Balance When Making Inductive Measurements, May 1962 (revised)	EB-18
Strength for the Weak Spot in DC Potentiometry, George D. Vincent and Marion L Roberts, Presented at Measurement Standards Instrumentation Conference, Instrument Society of America, October 1965	TA-9
Systemetrics, A New Concept in Electrical Measurements R M Pailthorp, May 1964	EB-42
Traceability of Resistance Measurements, Jack C Riley, April 1962	EB-30
Transformer Bridge Theory and Practice Jack C Riley, January 1964 (revised)	EB-31
Use of External Q Rheostat With Model 250 May 1962 (revised)	EB-11
Voltage Divider Calibration, <i>ESI Design Ideas</i> , January 1960	DI-1

Order
No.